

WPLC 19

Working Papers of the Linguistics Circle
of the University of Victoria



Vol. 19 (Aug. 2009)

Proceedings of the 23rd Northwest Linguistics Conference
Victoria B.C. Canada, Feb. 17-18 2007

WPLC 19

Working Papers of the Linguistics Circle of the University of Victoria
Vol. 19 (Aug. 2009)

– Proceedings of the 23rd Northwest Linguistics Conference (NWLC 23) –

Published by the graduate students of the University of Victoria Linguistics Department

c/o Department of Linguistics
University of Victoria
PO Box 3045
Victoria BC V8W 3P4
Canada

Telephone: +1 (250) 721-7424
Facsimile: +1 (250) 721-7423
E-mail: wplc@uvic.ca
URL: <http://web.uvic.ca/~wplc>

ISSN 1200-3344 (print edition)
ISSN 1920-440X (online edition)

© 2009 All rights retained by contributing authors.

WPLC 19

Working Papers of the Linguistics Circle of the University of Victoria
Vol. 19 (Aug. 2009)

– Proceedings of the 23rd Northwest Linguistics Conference (NWLC 23) –

CONTENTS

Acknowledgements	iii
Schedule of the 23 rd Northwest Linguistics Conference	iv

Contributed papers:

CONTRIBUTIONS IN SYNTAX & SEMANTICS

Sam Al Khatib	1
On the structure of possessives in Palestinian Arabic	
Fusheini Hudu	13
Focus marking in Dagbani	
Christiana Christodoulou	30
Anaphoric relations with Greek pronouns	
Yasuhiro Sasahira	48
<i>Not</i> does more than what the truth-functional negation can do	
Olga Steriopolo	71
Syntactic types of Russian expressive suffixes	
Sonja Thoma	109
St'át'imcets independent pronouns-the invisible cleft	
Antoine Tremblay	124
A radical construction grammar analysis of Mandarin Chinese SOV sentences	

CONTRIBUTIONS IN PHONETICS & PHONOLOGY

Janet Leonard	141
Preliminary investigation of the relationship between morphology and phonology in SENĆOŦEN (Saanich)	
Thomas Magnuson	153
The afterlife of morphemes: <i>Rendaku</i> and the search for ghosts in Japanese morphophonology	
Scott Moisik	164
Frequency, phonology, the brain, and second language acquisition: Laying the ground work for a hybrid approach	
Junsuk Park	189
Phonological changes in Korean	
Pauliina Saarinen	196
The effect of word-frequency on consonant gradation in Canadian-Finnish bilingual speech	
Jun Tian	217
An optimality theory analysis of diminutive suffixation of Beijing Chinese	

CONTRIBUTIONS IN APPLIED LINGUISTICS

Lan Kim & Fereshteh Rezaeian	232
Code-Switching in Persian/English and Korean/English Conversations: With a focus on light verb constructions	
Ya Li	245
English <i>tr</i> produced by Mandarin speakers	
Antoine Tremblay, Bruce Derwing, & Gary Libben	258
Are lexical bundles stored and processed as single units?	

ACKNOWLEDGEMENTS

Both the publication of this WPLC volume and the organization of the 23rd Northwest Linguistics Conference that inspired it have been made possible thanks to the efforts of a great many individuals. Among these are the staff, past and current graduate students, and faculty of the University of Victoria Linguistics Department, without whose support the present volume would not have come to fruition. The names which appear below represent a partial listing of those who have contributed to the realization of WPLC 19.

WPLC Editorial Board:

Izabelle Grenon
Thomas Magnuson
Dave Robertson

Rebeca Duque Colmenares
Jun Tian
Pauliina Saarinen

Review Panel:

Dr. Suzanne Gessner
Dr. Leslie Saxon
Laura Hawkes
Janet Leonard
Joseph Martel

Dr. Dave McKercher
Dr. Suzanne Urbanczyk
Sunghwa Lee
Ya Li
Pauliina Saarinen

Cover Artwork:

"Racination" by Scott Moisik

Schedule of the 23rd Northwest Linguistics Conference
University of Victoria
February 17-18, 2007

Saturday, February 17, 2007		
8:30-9:00	<i>Breakfast and registration</i>	
9:00-9:30	<i>Opening Remarks</i>	
9:30-10:30	Plenary Speaker: Dr. Dave McKercher, University of Victoria "Learning about the plural and past tense: Regularity trumps reliability"	
10:30-10:45	<i>Coffee Break</i>	
	<i>Hickman Building Room 110</i>	<i>Hickman Building Room 116</i>
	Session 1: First Nations Languages Chair: Dave Robertson	Session 2: Phonetics & Phonology Chair: Hua Lin
10:45-11:15	Onowa McIvor (University of British Columbia) TBA	Jun Tian (University of Victoria) "An Optimality Theory analysis of diminutive suffixation of Beijing Mandarin"
11:15-11:45	Marianne Nicolson (University of Victoria) TBA	Sunghwa Lee (University of Victoria) "Familiarquency effect on phonetic variability"
11:45-12:15	Ruth Lyall (University of Victoria) "Conversations regarding Kwakwala"	Park Junsuk (Michigan State University) "Phonological changes in Korean"
12:15-1:30	<i>Lunch</i>	
1:30-2:30	Plenary Speaker: Dr. Suzanne Gessner, University of Victoria "Headedness and Agreement in Dakelh Relative Clauses"	
	<i>Hickman Building Room 110</i>	<i>Hickman Building Room 116</i>
	Session 3: Syntax I Chair: Janet Leonard	Session 4: Phonetics & Phonology Chair: Izabelle Grenon
2:30-3:00	Olga Steriopolo (University of British Columbia) "Universal diminutive syntax?"	Calisto Mudzingwa (University of British Columbia) "Spreading as a hiatus resolution strategy in Shona"
3:00-3:30	Antoine Tremblay (University of Alberta) "A radical construction grammar analysis of Mandarin Chinese SOV sentences"	Pauliina Saarinen (University of Victoria) "The effects of word-frequency on consonant gradation in Canadian Finnish bilingual speech"
3:30-3:45	<i>Coffee Break</i>	

3:45-4:15	Sam Al Khatib (Simon Fraser University) "On the structure of possessives in Palestinian Arabic"	Carolyn Pytlyk (University of Victoria) "A study of Mandarin rhythm"
4:15-4:45	Christiana Christodoulou (University of British Columbia) "On Greek pronouns and coreference"	Thomas Magnuson (University of Victoria) "The afterlife of morphemes: <i>Rendaku</i> and the search for ghosts in Japanese morphophonology"
6:00	Dinner Party at Smuggler's Cove 2581 Penrhyn Street 477-2688	

Sunday, February 18, 2007		
8:30-9:00	<i>Breakfast</i>	
9:00-10:00	Plenary Speaker: Dr. Li-Shih Huang, University of Victoria TBA	
	<i>Hickman Building Room 110</i>	<i>Hickman Building Room 116</i>
	Session 5: Semantics Chair: Pauliina Saarinen	Session 6: Applied Linguistics Chair: Laura Hawkes
10:00-10:30	Dennis Ryan Storoshenko (Simon Fraser University) "Antecedence possibilities for plural <i>caki</i> in Korean"	Ya Li (University of Victoria) "Investigating the English consonant cluster <i>tr</i> produced by native Mandarin speakers"
10:30-11:00	Yasuhiro Sasahira (University of Wisconsin-Madison) " 'Not' does more than what the truth- functional negation can do: The semantics of sentential negation"	Darren Tanner (University of Washington) "Surface deficits without representational deficits in L2 DP morphosyntax"
11:00-11:15	<i>Coffee Break</i>	
11:15-11:45	Fusheini Hudu (University of British Columbia) "Focus marking in Dagbani"	Scott Moisik (University of Victoria) "Frequency, phonology, and second language acquisition"
11:45-12:15	Yuanchen Jenny Yang (Yale University) "A revised time-relational analysis of the verbal <i>le</i> in Mandarin Chinese"	Fereshteh Rezaeian & Lan Kim (Simon Fraser University) "Code-switching in Persian/English and Korean/English conversations: With a focus on light verb constructions"
12:15-1:30	<i>Lunch</i>	

1:30-2:30	Plenary Speaker: Dr. Sonya Bird, University of Victoria " 'You say tom[a]to, I say tom[ei]to': Representing phonetic variability in our mental lexicon"	
	<i>Hickman Building Room 110</i>	<i>Hickman Building Room 116</i>
	Session 7: Syntax II Chair: Nicholas Welch	Session 8: Phonology Chair: Carolyn Pytlyk
2:30-3:00	Antoine Tremblay, Bruce L. Derwing & Gary Libben (University of Alberta) "Are lexical bundles stored and processed as single units?"	Martin Oberg (University of British Columbia) "Question word intonation in St'at'imcets"
3:00-3:30	Sonja Thoma (University of British Columbia) "St'at'imcets independent pronouns as predicate-The invisible cleft"	Janet Leonard (University of Victoria) "Phonological domains in SENCOTEN"
3:30-3:45	<i>Coffee Break</i>	
		Session 9: Language documentation Chair: Carolyn Pytlyk
3:45-4:15		Becky Wood (University of Montana) & John Lyon (University of British Columbia) "A work in progress: Lawrence Nicodemus's Coeur d'Alene Dictionary: Linguists' edition"
4:15-4:45		Dave Robertson (University of Victoria) "French of the mountains: A first report"
4:45-5:00	Closing Remarks	

On the Structure of Possessives in Palestinian Arabic

Sam Al Khatib

Simon Fraser University

saa6@sfu.ca

ABSTRACT

This paper demonstrates the compatibility of Ritter's (1988, 1991) analysis of Construct States with Palestinian Arabic. Her conclusions regarding the behaviour of possessive constructions will be shown to explain the grammaticality of Palestinian Arabic Genitive Objects, as well as the idiomaticity of Construct State expressions and non-idiomaticity of the Free Genitive equivalents.

Keywords: Construct State; Free Genitive; Genitive Object.

1 Introduction

In this paper I argue in favour of Ritter's (1988, 1991) analysis of Construct States and Free Genitives by testing it against Palestinian/Levantine Arabic nominal idioms and Genitive Objects. I will show that the idiomaticity of certain Construct State expressions (and the non-idiomaticity of their respective translations to Free Genitives) results from the syntactic differences proposed in Ritter (1991). I will show further that the grammatical behaviour of Genitive Objects in Palestinian Arabic can be accounted for using Ritter's (1991) case-motivated movement of DPs in nominal constructions.

The paper is organized as follows. In section 2 an overview of Construct States and Free Genitives is outlined, in which I go over the relevant assumptions that she makes; in section 3 I illustrate the compatibility of her analysis with the observed number/gender agreement between the Genitive particle and the possessee noun in Palestinian Arabic; in section 4 I show how Ritter's (1988, 1991) analysis fits with the idiomaticity judgements of some selected Construct State expressions and their Free Genitive "equivalents"; in section 5 I give a brief exposition of Genitive Objects, and show that their syntactic behaviour is compatible with her account.

2 Construct States and Free Genitives

2.1 Construct States

The Construct State (also known as the synthetic possessive) is a nominal possessive construction commonly found in Semitic languages in which the possessee noun precedes the possessor DP, as in example (1).

- (1) *beyt ha- mora* (Modern Hebrew)
beyt el- modarres (Palestinian Arabic)
 house the- teacher
 “the teacher’s house”

Following Abney’s DP hypothesis (1987), Ritter (1988) argues that the word order found in Construct States results from the DP-internal raising of the head noun to the determiner head (in a similar fashion to the V-T movement that causes VSO order in Semitic languages.) The N-D movement is shown in Figure 1.

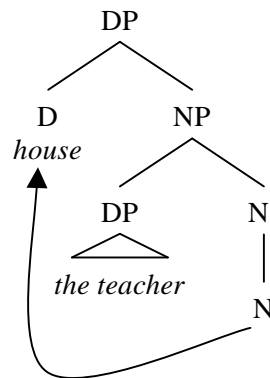
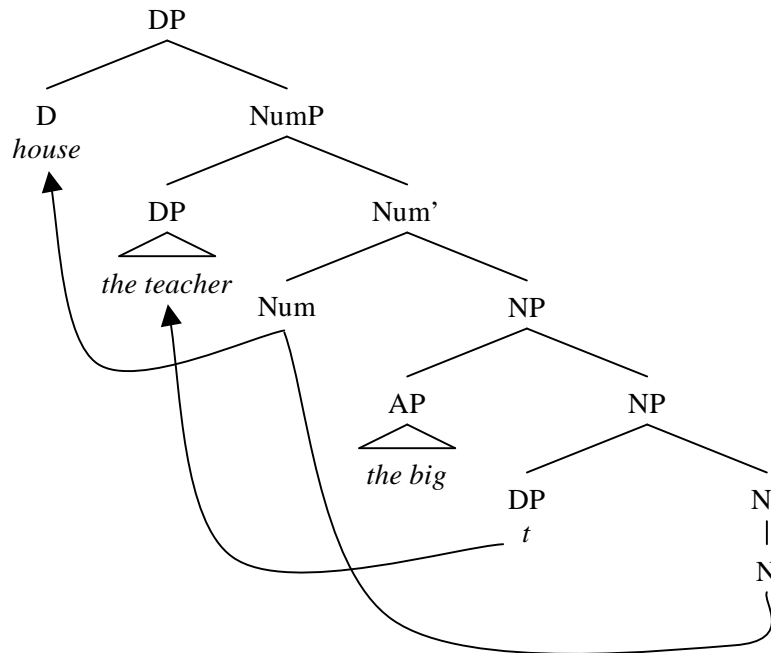

Figure 1

DP-internal N-to-D raising in Semitic Construct State.

Ritter (1991) hypothesizes another functional projection in the DP hierarchy in order to explain the occurrence of post-nominal adjectives. This projection, which she calls NumP, appears between the DP and the NP. The examples in (2) illustrate the position of adjectives in Construct States, and their corresponding syntactic structure is shown in Figure 2.

- (2) *beyt ha- mora ha- gadol* (Modern Hebrew)
beet el- modarres el- kbiir (PA)
 house the teacher the big
 “The teacher’s big house”

**Figure 2**

Post-nominal adjectives in Construct States.

An important assumption that Ritter (1991) makes is that the D_{gen} assigns case rightward. The possessor DP, which originates in [Spec,NP], moves to [Spec,NumP] in order to satisfy case-checking requirements. Since D_{gen} assigns case rightward, these requirements are fulfilled in that landing site.

2.2 The Free Genitive

The Free Genitive is another strategy for forming possessive constructions in Arabic and Hebrew. In Free Genitives (exemplified in (3) and shown in Figure 3) the definite article D can co-occur with the theme noun, thus entailing no N-to-D movement of the type found in Construct States. Under Ritter's (1991) analysis, the noun moves only as far as Num and the possessor DP must therefore co-occur with an overt GEN particle from which it can get case.

- (3) *ha- beyt (ha- gadol) shel ha- mora* (Modern Hebrew)
el- beet (el- kbiir) taa' el- modarres (PA)
 the house (the big) GEN the teacher
 "The teacher's big house"

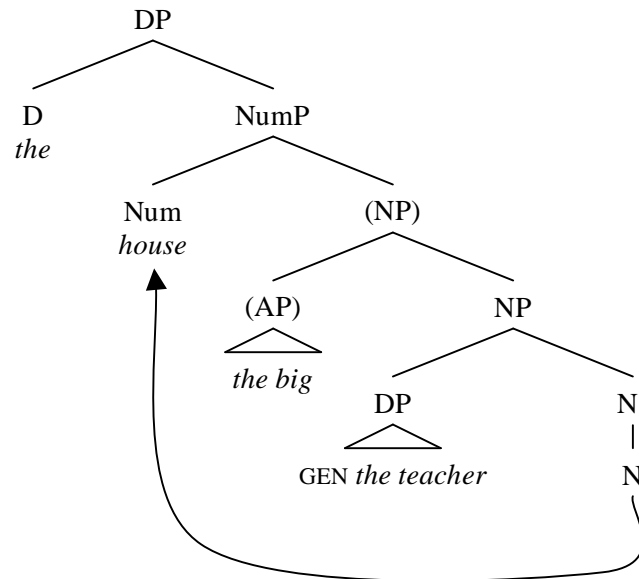
**Figure 3**

The syntactic structure of Free Genitives. Optional nodes (when adjectives are adjoined) are shown in parentheses. Note that the position of adjectives in the tree matches that of the grammatical DPs in (3).

3 The GEN Particle

In much of the literature on Modern Hebrew, the GEN particle is treated as a dummy marker that does not vary between different settings. But in Palestinian Arabic (hereafter PA), as well as in many other Arabic dialects, GEN agrees in gender and number with the theme noun. Examples are shown in (4). (The nouns ‘desk’ and ‘book’ are masculine in Arabic, while the noun ‘room’ is feminine.)

- (4) *el- maktab taa' iyad* (PA)
 the desk:m GEN.sg.m Iyad
- el- ghorfe taa'et iyad*
 the room:f GEN-sg.f Iyad
- el- kutub taaiin' iyad*
 the books:m GEN-pl.m Iyad
 “Iyad’s desk/room/books”

The possessor DP in (4), [GEN *Iyad*], appears in [Spec,NP], and the head nouns *desk*, *room*, and *books*, all originate in N, as demonstrated in Figure 4.

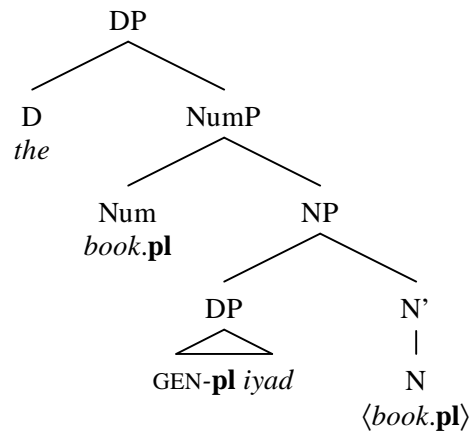
**Figure 4**

Number/Gender agreement in PA possessor DPs. Agreement is between the possessee (theme) noun and the Genitive particle that occurs inside the possessor DP, which appears in the head's specifier position.

What we have, then, is an agreement relation between a head and the content of the phrase in its specifier position, a configuration which is not at all unusual and which, in this case, supports the application of Ritter's (1991) account to PA.

4 Idioms

PA idioms provide support for Ritter's (1988, 1991) analysis of Construct States and Free Genitives. The expressions in (5) are idiomatic only as CSs (5a-c). In the Free Genitive (5d-f), the expressions are either interpretable only literally (5f) or simply anomalous (5d-e).

- (5) a. *shahr el- 'asal*
month the honey
"honeymoon" (literally: "the month of honey")
- b. *njuum edh- dhohor*
stars the noon
"hell/a hard time" (literally: "the stars of noon")
- c. *ħaliib en- nawar*
milk the gypsies
"uncivilized behaviour" (literally: "the milk of gypsies")
- d. *esh- shahr taa' el- 'asal*
the month GEN the honey
"the month of honey" (literal; non-idiomatic)

- e. *en- njuum ta'een edh- dhohor*
 the stars GEN the noon
 “the stars of noon” (literal; non-idiomatic)
- f. *el- ḥaliib taa' en- nawar*
 the milk GEN the gypsies
 “the milk of gypsies” (literal; non-idiomatic)

While Ritter (1991) argues for a unified analysis of both Construct States and Free Genitives, it is important to note that the differences she posits between the two constructions do account for the (non-)idiomaticities in (5). Recall that in Construct States, the head noun forms a constituent with the possessor DP (Figure 5a), while the noun takes a genitive DP in its specifier position in Free Genitives (Figure 5b).

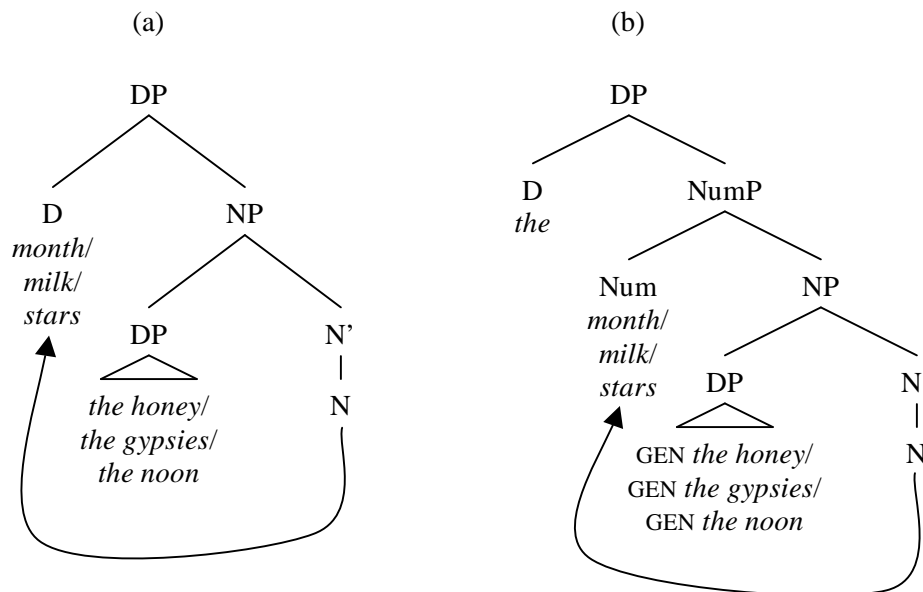

Figure 5

PA idioms in both CS and FG constructions: (a) and (b), respectively. The structural difference explains the (non-)idiomaticity of the expressions.

In both constructions, the lowest projection that groups the head noun together with its possessor is NP. But in FGs, this constituency is not possible without the support of the GEN particle. In other words, before the possessor phrase can merge with the head noun, the possessor noun must merge with the GEN particle. This derivation places the nouns *month*, *stars*, and *milk*, in a strict ‘ownership’ relation with the DPs *the honey*, *the noon*, and *the gypsies*, respectively, and the resulting meaning may only be literal and not idiomatic. Once again, Ritter’s (1988, 1991) analysis stands its ground against PA data.

5 Genitive Objects

Construct States are not limited only to possession relations. Consider the grammatical examples in (6).

(6) *bee'* *el-* *ardh*
 selling the- land
 “the selling of the land”

hazhr *et-* *tajawwul*
 prohibition the- wandering
 “the curfew”

hadm *el-* *madiineh*
 destruction the- city
 “the destruction of the city”

In (6), none of the DPs *the land*, *the wandering*, and *the city* are possessors of the nouns *selling*, *prohibition*, or *destruction*. The DPs are rather the themes of the actions represented by those nouns: *the land* is being sold, *the wandering* prohibited, and *the city* destroyed. Conformity with UTAH requires these DPs to originate in the complement position to the head nouns *selling*, *prohibition*, etc. But if APs are left-adjoined to NP and object DPs remain in situ (as complements to N,) then we would expect the adjectives to precede the object DPs, as shown in the ungrammatical tree in Figure 6. The examples in (7) show that this is not the case.

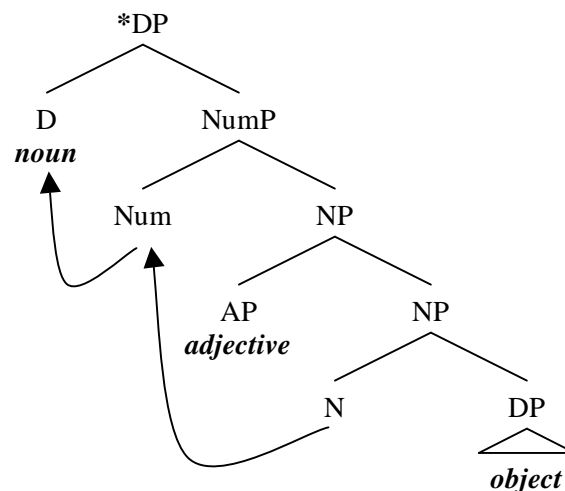

Figure 6

If the theme nouns were to remain in situ in Genitive Objects (which are adjoined with adjectives), then the expected order must be *noun-adjective-object*.

(7) *bee' el- mo'ajjal el- ardh
 *selling the hasty the land
 bee' el- ardh el- mo'ajjal
 selling the land the hasty
 "the hasty selling of the land"

*hazhr et- mafroodh et- tajawwul
 *prohibition the enforced the wandering
 hazhr et- tajawwul el- mafroodh
 prohibition the wandering the enforced
 "the curfew"

*hadm el- motawak~~h~~esh el- madiineh
 *destruction the monstrous the city
 hadm el- madiineh el- motawak~~h~~esh
 destruction the city the monstrous
 "the destruction of the city"

The post-nominal position of the APs in (7) indicates that the DPs *the land*, *the wandering*, etc. appear above the NP. We have already seen this in the CSs in section 1, in which the DPs originating at [Spec, NP] raised to [Spec, NumP] to get case (rightward) from D. Fassi Fehri (1993), as well as Borer (1999), offers a raising account of Genitive Objects, which I simplify and show in Figure 7: *object* DPs raise to [Spec, NumP] to get case. This implies that N (unlike its parallel V in VSO clauses) is incapable of assigning accusative case to its complement, and this is in fact confirmed in the transitive nominal constructions shown in (8).

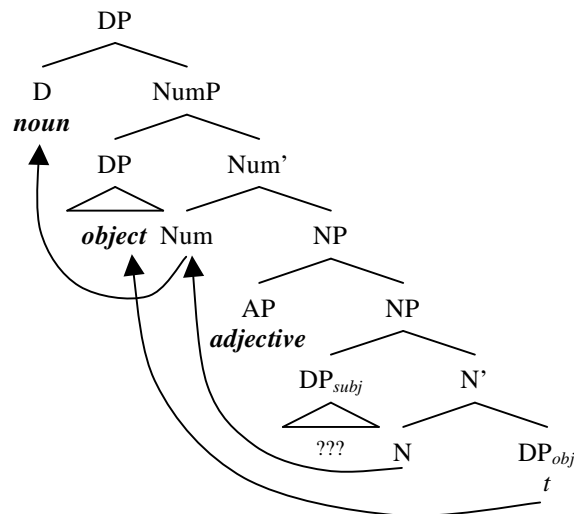

Figure 7
 The raising of object DPs to [Spec, NumP] in Genitive Objects.

- (8) **hob iyad mart-o*
 *love Iyad wife-his
hob iyad la mart-o
 love Iyad ACC wife-his
 “Iyad’s love for his wife”

Crucial here is the need for the preposition *la* to assign accusative case to the complement DP. But note also that a subject DP (*iyad*) raises from [Spec,NP] to [Spec,NumP] to get genitive case from the determiner head. With both [Spec,NP] and [Spec,NumP] occupied, the raising of the complement DP (when the preposition that would otherwise assign it accusative case is absent,) is an invalid move since no landing sites are available for the object DP. With an overt ACC particle preceding it, however, the object DP can remain in situ since the particle satisfies its case-checking requirements. This explains the (un)grammaticalities in (8) and is demonstrated in Figure 8.

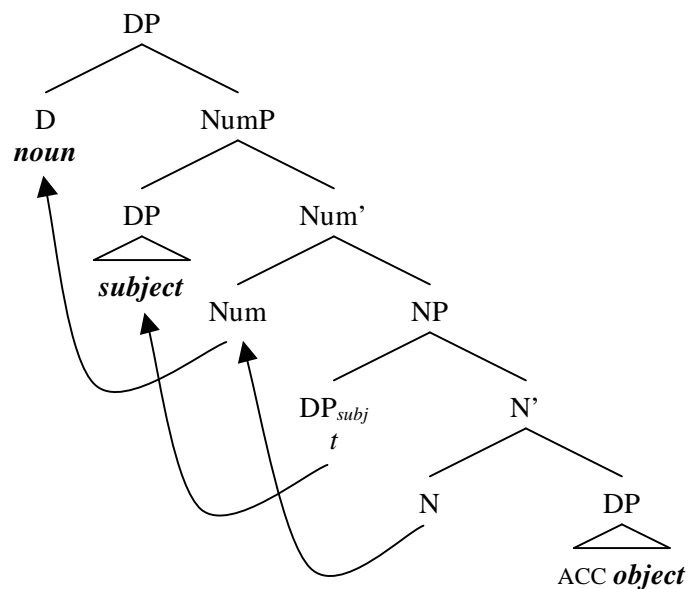

Figure 8

The appearance of the ACC marker on the object noun prevents its raising to [Spec,NumP]; since ACC assigns accusative case to the noun, its case-motivated movement is no longer required.

It was shown that in Genitive Objects, the DP appearing in [Spec,NumP] actually originates in the complement position, while in the transitive nominals in (8), it is the subject DP (originating at [Spec,NP]) that raises to [Spec,NumP]. But what occupies [Spec,NP] in Genitive Object constructions? Fassi Fehri (1993) argues that [Spec,NP] is occupied by a

PRO subject DP, and since PRO is by definition caseless, it has no case-checking requirements to fulfill and, thus, undergoes no raising. This is borne out by the grammaticality in (9).

- (9) *khedmet nafso ahamm shii 'end-o*
 helping himself important.sl thing for-him
 “helping himself is the most important thing for him”

Note the absence of an overt antecedent to the anaphor *himself*. If [Spec, NP] was empty, then (9) should be ungrammatical as it would violate Condition A. On Fassi Fehri’s analysis, however, the PRO appearing in [Spec, NP] prevents the construction from committing that violation, and that explains the grammaticality of the sentence. Figure 9 shows the general structure of Genitive Objects and the movements involved in forming them.

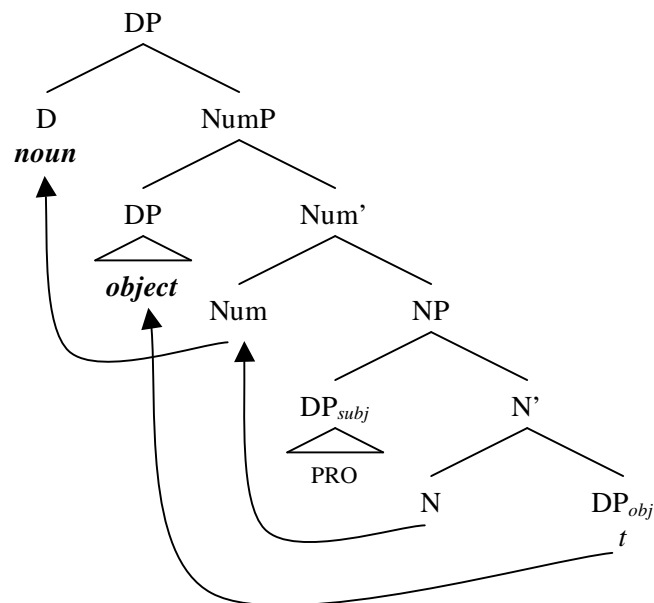

Figure 9

The syntactic behaviour of PA Genitive Objects.

Two points should be made before wrapping up. (1) Because it was Ritter’s (1988, 1991) analysis that I set out to examine, I did not explore the possibility of EPP-motivated DP-raising. Ritter (1991) uses case checking to explain the attested DP positions in CSs and FGs, and following Fassi Fehri (1993) and Borer (1999), I offer further verification for her analysis using PA Genitive Objects. (2) Raising to satisfy EPP may apply to a PRO DP, and if it was EPP that caused the raising to [Spec, NumP], then in Genitive Objects, the PRO would raise to check EPP and the object DP would remain in situ. This would produce the incorrect word order shown in (10). (These are the same ungrammatical constructions in (7).)

- (10) **bee'* *el-* *mo'ajjal* *el-* *ardh*
 *selling the hasty the land
 "the hasty selling of the land"
- **hazhr* *el-* *mafroodh* *et-* *tajawwul*
 *prohibition the enforced the wandering
 "the curfew"
- **hadm* *el-* *motawakkash* *el-* *madiineh*
 *destruction the monstrous the city
 "the destruction of the city"

The discussion in this section followed Ritter's (1991) case-motivated account of DP movement in Construct States, and showed that her analysis is supported by the behaviour of Genitive Objects and transitive nominals in PA. In Genitive Objects, object DPs raise to [Spec,NumP] to check case from D, and the resulting word order matches that of grammatical DPs in PA. In transitive nominals, the subject DP raises to [Spec,NumP] to get case from D, leaving no landing sites for object DPs. It was shown empirically that this scenario produces ungrammatical constructions *unless* the object DP is accompanied by an overt ACC particle that checks its case. Ritter's (1988, 1991) analysis fits well with PA.

6 Concluding Remarks

I have shown that Ritter's (1988, 1991) analysis of Hebrew DP constructions is applicable to PA. This comes as no surprise given the genetic affinity between the two languages. But I'll add that the syntax of DPs has changed during the evolution of Classical Arabic into PA (and the numerous other Arabic dialects that emerged.) Classical Arabic had a rich inflectional system that placed little restriction on word order in comparison to the modern dialects. In DPs, for instance, Classical Arabic allowed transitive CSs without the aid of an ACC particle before the object. What is ungrammatical in PA, (see (11),) was in fact perfectly grammatical in Classical Arabic if the words were properly inflected.

- (11) **ħob* *iyad* *mart-o*
 *love Iyad wife-his
- ħob* *iyad* *la* *mart-o*
 love Iyad ACC wife-his
- ħubbu* *iyad-en* *emra'at-i-hi* (Classical Arabic)
 love Iyad-GEN wife-ACC-his
 "Iyad's love for his wife"

Further research may show whether similar changes took place in the development of Modern Hebrew from Biblical Hebrew, or in the development of New Babylonian from Old Babylonian, and may further investigate the corresponding syntactic behaviour of VPs/TPs in each of these languages.

Acknowledgments

Many thanks are due to Dr. Chung-hye Han for her support and supervision, and to Andreea Kosa for her input.

References

- Abney, S. (1987). *The English Noun Phrase in its Sentential Aspect*, Ph. D., MIT, Cambridge, Mass.
- Borer, H. (1999). "Deconstructing the Construct", in Kyle Johnson and Ian Roberts (eds.) *Beyond Principles and Parameters. Essays in Memory of Osvaldo Jaeggli*. Dordrecht, Kluwer, pp. 43-89.
- Fassi Fehri, A. (1993). *Issues in the Structure of Arabic Clauses and Words*. Dordrecht: Kluwer.
- Ritter, E. (1988). "A Head Movement Approach to Construct State Noun Phrases". *Linguistics* 26(6):909-929.
- Ritter, E. (1991). "Two Functional Categories in Noun Phrases: Evidence from Modern Hebrew". *Syntax and Semantics* 25:37-62.

Focus marking in Dagbani

Fusheini Hudu

The University of British Columbia

Hudu28@gmail.com

ABSTRACT

This paper analyses the semantics of focus marking in Dagbani, a Gur language spoken in Ghana, arguing that the language marks two kinds of focus: contrastive and presentational focus. It further argues that contrary to previous analysis of Dagbani such as Olawsky (1999), the particles *ka*, *n*, *la*, and *mi* all mark focus in the language. Typologically, Dagbani is unlike many languages, as contrastive focus is marked only by the presence of one of these focus markers, while constituents that are not marked by any focus particle are presentational focus positions. The analysis is presented using mainly Kiss's (1998) distinction between the two types of focus and a test of contrastivity devised by Szabolcsi (1981). While Szabolcsi's test can be used to show exhaustive identification of constituents focused by *ka*, *n*, and *la*, it fails to show exhaustivity in verbs that are focused by the particle *mi*.

Keywords: Dagbani; Gur; focus marking; contrastive focus; presentational focus; exhaustivity

1 Introduction

Even though previous account of Dagbani (Olawsky 1999) discusses focus marking in the language, the role of the particles *ka*, *n*, *la*, and *mi* as focus markers has not been fully explored. Of these particles, *ka* has received the most attention as a focus marker, as it marks focus through movement of the focused element into initial position at LF, or positioning of the particle clause-initially. *la* has not received a detailed analysis as a focus marker in Dagbani. Olawsky (1999), for instance, includes it among aspectual markers but notes a number of problems with such an analysis, and presents the evidence suggesting its role as a focus marker. He also treats *mi* only as an emphatic marker added to the imperfective marker *di* when no object follows, to form *di-mi*. But the particle *n* has not been identified as a focus marker. This paper argues that all these particles are focus markers. It further shows that each of them marks contrastive focus, while focused constituents that are not marked with any particle are presentational focus positions. In many languages, the focus type of a constituent depends on its structural position in the sentence. (See Kiss 1998 for a review of languages that show this pattern, including English, Hungarian, Italian, Rumanian, Catalan, Greek, Arabic, and Finnish). But in Dagbani, a constituent can not mark contrastive focus unless it has a focus particle. This makes Dagbani different from these languages.

The analysis makes use of Kiss (1998)'s distinction between these two types of focus (contrastive and presentational focus), which she refers to as identificational focus and information focus. Contrastive focus does not convey new information but expresses exhaustive identification as the specifier of a functional projection; differing from presentational focus which marks new non-presupposed information and involves no movement. Details on the distinction between the two types of focus including their distributional features are discussed and applied to Dagbani focus markers.

While all the particles mark focus in situ, *ka* additionally marks focus through movement to initial position, forming a cleft construction. *n* also creates a cleft; but unlike *ka*, it focuses sentence-initial constituents while the other particles focus non-initial elements. The particles also mark positions with different grammatical and thematic roles. *ka* focuses objects and other constituents that are underlyingly in post-verbal position, *n* focuses the subject that is also the agent or experiencer, and *la* goes with the object that performs the role of goal, theme or destination. *mi*, on the other hand, focuses the action, event, or state encoded by the verb in the sentence. An example for each particle is shown in (1); with pairs showing none contrastively focused variants of each position. In this paper, contrastive focus is shown in bold type while presentational focus is presented in small capital fonts. Note that the perfective marker becomes zero in a sentence when it has an object or when the verb is followed by a focus marker¹.

(1) Dagbani focus particles.

- | | |
|-------------------------------------------------------------------------------|--------------------------------------------------------------------------------------------------------|
| a. i. n zaŋ-∅ AMINA na.
1sg. take-∅ Amina loc.
I brought AMINA | ii. Amina ka n zaŋ-∅ na
Amina foc. 1sg. take-perf. loc.
It is Amina that I brought |
| b. i. N zaŋ∅ Amina na.
1sg. take-perf. Amina loc.
I brought Amina | ii. mani n zaŋ∅ Amina na
1sg.emph. foc. take Amina loc.
It is me who brought Amina |
| c. i. Abu tʃaŋ∅ DA: ni.
Abu go-perf. market loc.
Abu went to the MARKET | ii. Abu tʃaŋ∅-la da: ni.
Abu go-perf.-foc market loc.
Abu went to the market |
| d. i Adam DA-∅ (li)
Adam buy-perf (3sg.inanim.)
Adam BOUGHT (it). | ii. Adam da -∅ (li) mi
Adam buy-perf (3sg.inanim.) foc.
Adam bought (it). |

¹ Abbreviations used in this paper include: 1, 2, and 3 = first, second and third person respectively, anim. = animate, conj. = conjunction, emph = emphatic, foc. = focus, fut. = future, imperf = imperfective, inanim. = inanimate, loc. = locative, neg. = negative morpheme, perf = perfective, pl. = plural, sg. = singular, TD = time depth marker.

The rest of the paper is organised as follows: In the next section, features of the two types of focussed constituents are presented and the distinction between them shown. Section 3 discusses the particles further and shows how they mark contrastive focus. In section 4, one of these features is used to show the distinction between the two focus notions in Dagbani, demonstrating that all these mark contrastive focus. Section 5 concludes the paper.

2 Contrastive and presentational focus

Kiss's (1998) account of the difference between the two focus notions hinges mainly on exhaustivity and movement. She defines contrastive focus semantically as one that represents the value of the variable bound by an abstract operator expressing exhaustive identification, and syntactically as the constituent that acts as an operator moving into scope position and binding a variable. Contrastive focus 'represents a subset of the set of contextually or situationally given elements for which the predicate phrase potentially hold; it is identified as the exhaustive subset of this set for which the predicate phrase actually holds' (Kiss 1998 246). Since some sentences are not marked for it, this focus type is non-obligatory.

This contrasts with presentational focus which is obligatorily expressed in every sentence and marked by a pitch accent. It is expressed by a phrase that conveys new and non-presupposed information without any movement, and that does not express exhaustive identification on given entities. The two focus notions also differ in that whereas presentational focus places no restriction on constituents that mark it, some constituents such as universal quantifiers and *also*-phrases can not express contrastive focus. The differences between the two types of focus can be summarised in (2).

(2) Differences between contrastive and presentational focus (Kiss 1998).

Contrastive focus	Presentational focus
expresses exhaustive identification	marks non-presupposition
restriction on some constituents, e.g. universal quantifiers, <i>also</i> -phrases etc	no restriction on constituents
takes scope	does not take scope
moved to spec position	no movement involved
always co-extensive with an XP available for operator movement	either smaller or larger
can be iterated	can project
may not be in a sentence	present in every sentence

The next section presents a detailed discussion on the focus markers showing mainly contrastive focus is marked.

3 Dagbani focus Markers

3.1 *ka*

This particle focuses post-verbal constituents by pre-posing them into initial position and forming a cleft construction. Subjects and other preverbal constituents can only be clefted with the use of *n* focus marker, as discussed in below. Constituents that can be focused include noun phrases, emphatic pronouns and adjuncts. These are shown in (3).

(3) Focusing with *ka*.

- | | | | |
|----|---------------------------------------------------------------------------------------------------------|---|------------------------------------------------------------------------------------------------------------------------------------------------------------------------|
| a. | n zaŋ-Ø AMINA na
1sg. take-perf. Amina loc.
I brought AMINA | > | Amina ka n zaŋ-Ø na
Amina foc. 1sg. take-perf loc.
It is Amina that I brought (not Adam) |
| b. | Baba ŋa-Ø DO SO ŋUN BE DU: MA:
B. see-perf. man.sg. who be room def.
Baba saw THE MAN IN THE ROOM | > | do so ŋun be du: ma: ka Baba ŋa-Ø
man.sg. who be room def. foc. B. see.perf.
It is the man in the room that Baba saw,
(not the man standing behind me) |
| c. | ti da:tfaŋ tiŋ BOBGU
1pl. TD go city several
We went to SEVERAL CITIES | > | tiŋ bobgu ka ti da:tfaŋ
city several foc. 1pl. TD go
It is to several cities that we went, (not only
Accra) |
| d. | ji so ŋa-Ø do: ma: SOHILA
3pl. TD see-perf. man def. yesterday
You saw the man YESTERDAY | > | sohila ka ji so ŋa do: ma
yesterday foc. 3pl. TD see man def.
It is yesterday that you saw the man,
(not earlier today) |
| e. | bi juri MA
3pl. love 1sg.obj.
They love ME | > | mani ka bi jura
1sg.emph. foc. 3pl. love
It is me that they love, (not my daughter) |

Adverbials of time display an exceptional pattern in that they can be pre-posed and focused in initial position without the use of *ka*. Thus (3d) could be expressed as it would normally be done in English, (4a), just like the adverbial *pumponjo* in (4b). The only exception is when they occur in WH questions, in which case the use of *ka* becomes obligatory, as shown in (4c and d). When these adverbials are pre-posed without the use of *ka*, the contrastive reading we get with the use of *ka* is lost.

(5a ii) occurs as an imperative given by a hunter to his son in a context where the latter spots a bird within a reasonable distance, and informs his father. In this context, a number of options the boy might be considering, which the father should be aware of, include calling on the father to kill the game, shooting the bird, or throwing his stick at it. The question in (5a ii) is thus not one that demands an answer, but focuses one of these options in his instruction to the young hunter on what action to take, a feature that is lacking in (5a i). The hunter is thus instructing the son to forget about any other option and take what he has chosen for him². A similar context could be imagined for (4b iii). Thus the focus value of *ka* in (5) depends on shared knowledge of the context that the speaker has with the listener.

(5b i) shows that pre-posing *ka* in initial position of a non-negative sentence changes the grammatical function of this morpheme into a conjunction. And as was already noted in the previous examples, the second reading of (5a i) and (5b ii) each presents a meaning similar to (5a ii) and (5b iii) respectively, the only difference being the lack of focus in the former.

Another difference between focusing entire clauses with *ka* and focusing pre-posed elements with the same is that the former is achieved only with the pitch accent unique to questions that begin with the person pronoun, as shown in the second readings of (5a i) and (5b ii). Without this accent, *ka* in (5a ii) and (5b iii) loses its focus value, rendering the sentences a simple negative statements. Keeping much of the context already sketched out that gives *ka* its focus value in (5a ii), (see footnote 2 and preceding discussion) a different context could emerge where *ka* would lose its focus value. If the hunter had seen his son looking at the bird and never made an attempt at killing it, or drawing his (hunter's) attention until the bird flew away, the hunter might narrate the story to his son later on thus: *I saw you from a distance looking at a bird. ka a bɪ labɪ-rɪ o* (And I noticed) that you were not throwing/making an attempt to throw (your stick) at it until it flew away. In this context, *ka* is being used as a conjunction between the two clauses.

(5b iii) could also occur in a context where a person who is sick or under some condition and refuses to eat is told: *you are sick and (I observe that) you are not eating*. In the two contexts sketched here, there is a sense of disapproval, although it may not always be present, as the person addressed failed to do what was expected under the circumstance. This second focus function of *ka* (focusing whole clauses) will not be discussed any further in the rest of this paper. Any reference to *ka* as a focus marker will be restricted to its use after constituents have been moved into initial position.

3.2 *n focus*

*n*³ focuses the noun phrase or emphatic pronoun in subject position. It produces a cleft construction and differs from *ka* only in that no overt surface movement is involved. Where the sentence has a non-pronominal subject, the only measure that is taken to focus the subject is the insertion of the focus marker, as in (6a, b and c). But where the subject is pronominal, it becomes emphatic when focused, as (6d and e) show.

² In the larger folk story in which this imperative occurs, the reply of the son's is: 'there is no hunting stick'. Then the father responds: 'come for one'. Then the child says "the bird has flown".

³ The place of articulation of this nasal changes due to nasal place assimilation, as shown in the examples below.

- (6) Focusing with the particle *n*.
- a. i. AMINA tcaŋ-∅ da: ni
Amina go-perf. market loc.
AMINA went
- ii. **Amina** n tcaŋ-∅ da: ni
Amina foc. go-perf. market loc.
It is **Amina** who went, (not Asana)
- b. i. kum mali Abu
Hunger has Abu
Abu is HUNGRY
- ii. **kum** m mali Abu
hunger foc. has Abu
It is **hunger** that Abu feels (not sickness)
- c. i. DA:ni tʃAN-di mali Amina
market go-imperf. has Amina
A. has the desire to GO TO THE MARKET. It is **the desire to go to the market** that
- ii. **da:ni** tʃan-di m mali Amina
market go-imperf. foc. have Amina
Amina has (not the desire to shop)
- d. i. N zaŋ-∅ Amina na
1sg. take-perf. Amina loc.
I brought Amina
- ii. **mani** n zaŋ-∅ Amina na
1sg.emph. foc. take-perf. Amina loc.
It is **me** who brought Amina. (She did not come by herself)
- e. i. JI be du:
2pl. be room
YOU are in the room
- ii. **jinimi** n be du:
2pl.emph foc. be room.
'It is **you folks** who are in the room (and no one else).

3.3 Focusing with *la*

Olawsky (1999) includes *la* among aspectual markers (although he glosses it both as an aspectual and a focus marker) that marks both habitual and continuous meaning inserted between the verb and the object. He uses the data in (7) as exemplifying the process.

(7) *la* as an aspectual marker?⁴

- a. Fati bari la tʃetʃe
 Fati ride imperf.foc. bicycle
 Fati is riding a bicycle
- b. m bɔhindi la Dagbanli
 I learn imperf.foc. Dagbani
 I am learning Dagbani.

(Olawsky 1999: 38)

But he also notes the lack of relationship between tense and aspect on the one hand, and the function of this marker on the other, as well as the possibility that *la* may actually mark emphasis. For instance, in Dagbani, transitive and intransitive verbs that occur in sentence final positions (i.e. with no overt objects) are obligatorily marked for aspect, (8a and b). If *la* were an aspectual marker, we would expect it to occur in such final positions. But *la* does not occur in such positions as (8c) shows.

(8) *la* versus aspectual markers.

- | | |
|---------------------------------------------------------------|------------------------------------------------------------------------------|
| a. i. baa kpi-ja
dog die-perf
A dog has died/is dead | ii. baa kpi-ra
dog die-imperf
A dog dies/is dying |
| b. i. Abu da-ja
Abu buy-perf.
Abu has bought | ii. Abu da-ra
Abu buy-imperf.
Abu buys/is buying |
| c. i. *Fati di-ri-la
Fati eat-imperf-la
*Fati is eating | ii. Fati di-ri-la bindirgu
Fati eat-imperf-la food
Fati is eating food |

Olawsky further observes that since focus markers only mark emphatic constituents, the non-occurrence of *la* before non-emphatic pronouns supports its role as a focus marker, rather than a marker of aspect. This view is further strengthened by the fact that *la* is followed by constituents of different categories besides objects, whereas aspectual markers typically occur before nouns. And since *la* does not focus the verb, there is no basis to argue that it is a portmanteau morpheme expressing both focus and aspect. Besides, as shown in (9b) below, failure to focus any constituent in a sentence with *la* does not necessarily mean that the verb loses its perfective meaning.

⁴ For the purpose of consistency, the transcription of all cited data on Dagbani has been slightly changed from the original.

- (9) Focusing with the particle *la*.
- | | |
|-------------------------------------|--------------------------------|
| a. i. Abu da-∅ la bu-a . | ii. Abu da-∅- la bo ? |
| Abu buy-perf. foc goat-sg | Abu buy-perf-foc. what |
| Abu bought a goat | Abu bought what |
| b. i. Abu da-∅ bu | ii. Abu da-∅ bo ? |
| Abu buy-perf. goat | Abu buy-perf. what |
| Abu bought A GOAT | Abu bought WHAT? |
| c. i. Abu ti-∅ la mani | ii. Abu ti-∅ la ŋuni ? |
| Abu give-perf. foc. 1sg.emph. | Abu give-perf. foc. who |
| Abu gave (it to) me . | Abu gave who ? |
| d. i. Abu chaŋ-∅ la da: ni . | ii. Abu chaŋ-∅- la ja ? |
| Abu go-perf. foc market loc. | Abu go-perf-foc. where |
| Abu went to the market | Where did Abu go? |
| e. i. *Abu da-(la o | ii. Abu da-(- la bo |
| Abu buy-perf. foc 3.sg. | Abu buy-perf.-foc what. |
| Abu bought it | Abu bought what? |
| f. i. *Abu zu-(la | ii. *Abu n -(la ? |
| Abu steal-perf. foc. | Abu do-perf. foc. what |
| Abu stole | Abu did what? |

In (9), *la* always occurs before the focussed constituent, including full NPs, (9a), emphatic pronouns, (9c), adjuncts, (9d), and WH phrases, (9a – d), but not before non-emphatic pronouns, as in (9e). And this focussed element can not be elided, as in ungrammatical (9f).

The second sentence of each pair in the examples in (9), with the exception of (9b), shows the typical focussed question to which a focussed answer, the first of each pair, could be given. (9b) shows the non-focussed counterpart of (9a) and similar examples could be generated for the rest of the examples. (9f) is important in showing that the focused element in the sentence is neither the predicate nor the subject but whatever follows the verb.

Another piece of evidence against *la* being a marker of aspect is that, where as no single clause can be marked with two aspectual markers, *la* occurs with the imperfective aspectual marker. In fact, a more detailed gloss of the data in (7), cited from Olawsky (1999), will reveal that *ri* in *bari* (7a) and *di* in *bəhindi*(7b) are the imperfective markers while *la* marks focus in both sentences. The two verb roots can be inflected with the perfective aspectual marker (*ba-ja* and *bəhim-ja*) when they occur in sentence final positions, and with a zero perfective morpheme when they take an object or focus marker or both (*ba-* (*la bu* a “rode a donkey” and *b h m-* (*la* Dagbanli “learnt Dagbani”).

3.4 Focusing with *mi*⁵

Of all the focus markers, the most difficult to analyse is *mi*. Like the other focus markers, *mi* shows contrast in focusing the action of the verb, as the examples in (10) illustrate. However, it does not pass the standard test of contrastivity proposed by Szabolcsi (1981), as will be shown in section 4.2.4.

(10) Focusing with the particle *mi*.

- a. Adam **da-∅** (li) mi
Adam buy-perf (3sg.inanim.) foc.
Adam **bought** (it). (He did not receive it for free).
- b. Baba **kuhi-ri** mi
Baba cry-imperf. foc.
'Baba **is crying**. (He is not laughing)
- c. tɔha da: ji kuli tʃani moʔu ni, o **doli-mi**. (Yahaya 1995: 20)
hunter TD when. ever go.impf. bush loc. 3sg. follow.perf.-foc.
Whenever the hunter was going to the bush he **would follow**'. (not stay at home)
- d. Kande **ka-∅-mi-na** da: ni
Kande come-perf.-foc.-loc. market loc.
Kande **came** to the market'. (She did not wander about in the neighbourhood)
- e. Abu **yeli-∅-mi** ni kum mali o
Abu say-perf.-foc. that hunger has 3sg.
Abu **said** that he is hungry'. (he did not leave us to guess from his looks).
- f. ?Fatima **bob** bob-gi mi
Fatima wear headscarf-sg foc.
Fatima **has worn** a headscarf'. (She is not going with her head uncovered)

An alternative analysis of *mi* presented by Olawsky is that it emphasises the imperfective marker *di* or its allomorph *ri* when the sentence does not have an object in final position. If

⁵ *mi* is generally realised in a sentence phonetically as *mi* as part of the pattern of neutralisation between /i/ and /ɨ/ in the language. Following tradition, which partly the results of the lack of /ɨ/ in the orthography, I represent the particle as *mi*. In actual examples, I show the actual phonetic realisation.

this were the most accurate description of the function of this particle, we would expect only examples such as (10b), where *mi* occurs with the imperfective morpheme, to be the only context in which this particle occurs. But as shown in other examples in (10), it occurs with perfective aspectual markers (10a, c, d and e) and in the Western Dialect; it possibly occurs disjoined from the verb in a sentence that has an object, (10f). These examples weaken the view that *mi* expresses imperfective aspect rather than focusing the verb.

In the rest of the paper, exhaustivity is used to show the extent to which the focus particles discussed in section 2 are contrastive.

4 Exhaustivity in Dagbani focus marking

4.1 Exhaustivity versus non-presupposition

Kiss identifies exhaustivity as the main motive for the distinction between contrastive and presentational focus. Every focus constituent either exhaustively identifies entities given in a context or marks them as information that is non-presupposed. This is illustrated using (4a), repeated in (11).

(11) Exhaustive identification with *n*.

- | | |
|----------------------------------------------------------------------------------|-----------------------------------------------------------------------------------------------------------------------------|
| a. AMINA tʃaŋ-∅ da: ni
Amina go-perf. market loc.
AMINA went to the market | b. Amina n tʃaŋ-∅ da: ni
Amina foc. go-perf. market loc.
It is Amina who went to the market (not Asana) |
|----------------------------------------------------------------------------------|-----------------------------------------------------------------------------------------------------------------------------|

The example in (11b) describes a situation where one person out of potentially many people went to the market. It presents the referent of Amina as a member of the P-set of the discourse and goes further to assert that of the many people in this set, Amina went to the market and that no other person went to the market besides her. (11b) thus exhaustively identifies Amina as the only one who went to the market. This sentence would be contradicted by any other which has a different referent in place of that of Amina, (e.g. Asana), as in (12).

(12) Contradiction of (11b).

- ASANA tʃaŋ-∅ da: ni
Asana go-perf. market loc.
ASANA went to the market

But (11a) lacks these features. It introduces Amina only as new and non-presupposed information. Its focus value is derived from the unique pitch accent that makes it more emphatic than the other eligible position, *market*. But because it does not contrastively

identify *Amina* as the one that went to the market, it would not contradict (12).⁶ (11a) could be derived in a context such as the discourse in (13) from which the focus value of *Amina* could be inferred, but which says nothing about the action of other participants in the discourse.

(13) Potential discourse for (11a).

- a. AMINA mini ASANA ji- Ø pu: ni na.
Amina conj. Asana leave-perf. farm loc. loc.
AMINA and ASANA have arrived from farm
- b. AMINA a tʃaŋ- Ø da: ni
Amina go-perf. market loc.
AMINA went to the market.

An important syntactic feature that further distinguishes constituents that express exhaustivity from those that do not is the structural position each occupies. Kiss claims that while presentational focus does not have a unique syntactic position, exhaustivity can only be expressed by a constituent pre-posed into preverbal slot. In other words all contrastive focus positions must be preverbal, while presentational focus positions may occur VP-internally or in situ. This feature is shown to prevail in many languages including English, Hungarian, Italian, Rumanian, Catalan, Greek, Arabic, and Finnish.

Kiss also identifies the English cleft construction and its equivalents in other languages as the relevant position where exhaustivity is expressed in these languages. She illustrates this with the Greek equivalent of “it is to Petro that they lent the book”, (14).

(14) Preverbal position of contrastive focus in Greek (Tsimpli 1994)

- a. Ston Petro dhanisan to vivlio
to.the Petro lent.3pl the book
It is to Petro that they lent the book.
- b. Dhanisan to vivlio ston Petro
They lent the book to Petro

Dagbani is not like these languages, as the focus type of a position does not depend on its structural position. As already shown, exhaustivity is marked only by the presence of a

⁶ However, it is not perfectly sound to say (12) after (11a). A more natural discourse is achieved only by conjoining the two clauses, as in *Amina tʃaŋ- Ø da: ni ka Asana gba tʃaŋ-Ø daa ni* ‘Amina went to the market and Asana also went to the market’. Nevertheless, between (11b) and (12), such a conjunction would still be unacceptable.

focus particle in a position, and a focus position can only express exhaustivity if it is in the same position as the focus particle. Since the language has no fixed position in a sentence that all contrastive focus markers must occur, there can not be a fixed position that all constituents that express exhaustivity can be found. Thus two of the contrastive focus positions, *n* and *ka*, are preverbal (15a and b) while *la* and *mi* are post verbal (15c and d).

(15) Positions of contrastive focus in Dagbani

- a. **da: ni tʃan-di** m mali Amina
market loc. go-imperf. foc. have Amina
'It is **the desire to go to the market** that Amina has, (not the desire to shop)'
- b. **do so ŋun be du: ma:** ka Baba ŋa- Ø
man.sg. who be room def. foc. Baba. see.perf.
It is **the man in the room** that Baba saw.
- c. Abu da-Ø la **bu**a.
Abu buy-perf. foc. goat
Abu bought **a goat**
- d. kɔm maa **mahi** mi
water def. cold foc.
The water is **cold**

4.2 Test of exhaustivity

So far, the claim that each of the particles expresses contrastive focus has not been put to test. In the rest of this section, the particles are tested using a test devised by Szabolcsi (1981).

In Szabolcsi's test, pairs of sentences are used; the first containing two co-ordinate DPs that are focused, and differs from the second only in that one of the coordinate DPs of the latter is dropped. Exhaustivity depends on the lack of logical consequence between the two sentences. The focus expresses exhaustive identification only if the second sentence is not among the logical consequences of the first. The test for each particle is presented and discussed below.

4.2.1 ka

- (16) a **Amina** mini **Abiba** ka ti ŋa-Ø du: ma: ni
Amina conj. Abiba foc. 1pl. see-perf room def. loc.

It is **Amina** and **Abiba** that we saw in the room

- b. **Amina** ka ti ɲa-∅ du: ma: ni
Amina foc. 1pl. see-perf room def. loc.

It is **Amina** that we saw in the room

- (17) a. ti ɲa-∅ AMINA mini ABIBA du: ma: ni
1pl. see-perf Amina conj. Abiba room def. loc.

We saw AMINA and ABIBA in the room

- b. ti ɲa-∅ AMINA du: ma: ni
1pl. see-perf Amina room def. loc.

We saw AMINA in the room

While (17a) entails (17b), (i.e. they do not contradict each other), the pair in (16) contradict each other). This shows that with *ka* no logical consequence exists between the pair in (16), as there is between those in (17).

4.2.2 *n*

n focussed constituents have the same effect as *ka* focussed one, (both being the equivalents of cleft construction in English). Thus the difference between (16) and (17) is exactly what is observed respectively in (18) and (19) below.

- (18) a. **kum** ni **kɔɲuri** m mali Abu
hunger conj. thirst foc. have Abu
It is **hunger** and **thirst** that Abu is suffering from

- b. **kɔɲuri** m mali Abu
thirst foc. have Abu
It is **thirst** that Abu is suffering from

- (19) a. KUM ni KɔɲURi mali Abu
hunger conj. thirst have Abu
Abu is HUNGERY and THIRSTY

- b. Kɔ-ɲURi mali Abu
 water-drinking have Abu
 Abu is THIRSTY

4.2.3 *la*

The use of *la* implies an assertion that the meaning expressed by the verb holds true for the entities in the focussed constituent. It thus has a similar effect as *ka* and *n*, since deletion of one of the co-ordinates will affect the truth value of the sentence. These are shown in (20) and (21).

- (20) a. Abu da-∅ la bu-a ni pɛ-ʔu
 Abu buy-perf. foc. goat-sg conj. sheep-sg
 Abu bought a goat and a sheep
- b. Abu da-∅ la bu-a
 Abu buy-perf. foc. goat-sg
 Abu bought a goat
- (21) a. Abu da-∅ BU-A ni Pɛ-ʔU
 Abu buy-perf. goat-sg conj. sheep-sg
 Abu bought A GOAT and A SHEEP
- b. Abu da-∅ BU-A
 Abu buy-perf. goat-sg
 Abu bought A GOAT

(21a) entails (21b), while the pair in (20) contradict each other.

4.2.4 *mi*

Even though the examples in (10) show that actions, events and processes focused by *mi* contrast with other actions, events or processes that the speaker/listener might have in mind, it does not pass the test of exhaustivity. Just as the two sentences in (23) do not contradict each other, those in (22) do not, in spite of focusing the verb with *mi*.

- (22) a. Adam me-∅ li mi ka pili-∅
 Adam build-perf. 3sg. foc. conj. roofed-perf.
 Adam built and roofed it

- b. Adam **pi**l-∅ li mi
 Adam roof-perf. 3sg. foc.
 Adam **roofed** it
- (23) a. Adam ME-JA ka PiLi-∅
 Adam build-perf. conj. roof-perf.
 Adam **BUILT** and **ROOFED**
- b. Adam ME-JA
 Adam build-perf
 Adam has **BUILT**.

Unlike the other focussed conjunctions, (22a) does not give the reading that Adam built and roofed it but did nothing else. But it does give the reading that he did not acquire it as a built and roofed entity. Thus it is not contradicted by the sentence in (22b). It would only be contradicted by a sentence that has a verb different from any of the two verbs in (22a). (22a) entails (22b) in the same way as (23a) entails (23b). Thus neither of the pairs express exhaustivity as the second of each pair is among the logical consequences of the first.

What makes *mi* obviously different from the rest of the particles is that, it focuses the verb. A conjunction of two predicates such as (22a) and (23a) makes two separate and independent claims about one entity, the subject, rather than one claim about different entities. Besides, since only one focus marker can be used in one sentence (even if it is multi-clausal), the focus particle does not seem to have the same effect on both clauses. In any such conjunction, *mi* follows the first verb, which suggests that it may not even have an effect on the second of the two conjoined clauses. This means that, unlike other focused positions, Szabolcsi's test is not suited for testing exhaustivity in predicate focus. Other possible tests of exhaustivity relevant for predicates are left for future studies of Dagbani focus.

5 Conclusion

What I have done in this paper is a basic description and analysis of focus in Dagbani, with emphasis on the semantics. The argumentation focussed mainly on the focus function of the particles *ka*, *n*, *la*, and *m*. But it also has typological relevance in two respects. First, the pattern in Dagbani presents an exception to Kiss' claim of universality of preverbal position for contrastively focussed positions. Second, it challenges the effectiveness of Szabolcsi's test in showing the differences between exhaustively focused predicates and those that are not exhaustive. Future study of *mi* and how it exhaustively identifies predicates thus promises to enrich the typology of focus.

However, the analysis presented here is not exhaustive, as only one of the several features that distinguish the two focus notions, exhaustivity, has been used. For future

research, issues that require attention include the syntax of focus in Dagbani, the semantic differences between the contrastive focus markers, and the extent to which the particles exhibit the other features that characterise the distinction between contrastive and presentational focus.

Acknowledgments

I am grateful to Lisa Matthewson and Henry Davis for their comments on the first draft of this paper which was submitted as a term paper for a syntax and semantics course they taught. I also thank Tyler Peterson for reading through the draft and making useful comments. All errors are mine.

References

- Büring, D. (2005). *Binding Theory*. Cambridge University Press. Cambridge.
- Kiss, K. E. (1998). Identificational focus versus Information focus. In *Language*. Vol. 74, 2. 245 – 273.
- Olawsky, K. J. (1999). *Aspects of Dagbani Grammar – with Special Emphasis on Phonology and Morphology*. Lincom. Munich.
- Rooth, M. (1985). *Association with Focus*. Ph.D. Thesis, University of Massachusetts, Amherst
- Szabolcsi, A. (1981). The semantics of topic-focus articulation. In *Formal Methods in the Study of Language*. Eds. Jan Groenendijk, Theo Janssen, and Martin Stokhof, 513 – 541. Amsterdam: Mathematisch Centrum.
- Tsimpli, I. M. (1994). Focusing in modern Greek. In *Discourse configurational languages*. Ed. Katalin E. Kiss, 176-206. New York and Oxford: Oxford University Press.
- Yahaya, R.M. (1995). *Dagbani karɔŋ piligu*. Bureau of Ghana Languages, Accra. Tema: Tema Press of Ghana Publishing Corp.

Anaphoric Relations with Greek Pronouns

Christiana Christodoulou

University of British Columbia
cchristy@interchange.ubc.ca

ABSTRACT

In the present paper I study coreference relations with Greek pronouns. Two alternative analyses are compared and contrasted to decide which of the two best accounts for the behaviour of pronouns in Greek. I first ascertain that the module of grammar that determines coreference relations (i.e. Binding Theory) cannot provide an inclusive analysis on the behaviour of Greek pronouns since it does not apply to any of the data presented in this paper. Second, following an analysis based on linear precedence, initially introduced by Williams (1997), I show that anaphoric relations in Greek are determined by the positioning of the pronoun in the sentence. Specifically, the pronoun needs to either follow the antecedent, or when the pronoun precedes the antecedent, it *must* be in a subordinate clause with respect to the antecedent. In addition, if the pronoun preceding the antecedent is in a matrix clause, then the antecedent CANNOT receive main sentence stress. Third, I establish that Williams' generalization needs to be extended to account for not only matrix-subordinate clause sentences, but also argument-adjunct.

Keywords: backward dependence/ pronominalization; coreference; binding; linear precedence; Greek pronouns; clitics; antecedent.

1 Introduction

If two expressions refer to the same individual, they are said to co-refer. Across languages, possibilities for coreference are partly structurally determined (i.e. Binding Theory). In this paper I discuss data which suggest that coreference relations in Greek cannot be explained through the traditional module of grammar, where coreference is determined by c-command. In these Greek data, the possibility of coreference is also determined by linear precedence. Therefore, I make use of an analysis based on linear order, under which such data can best be explained.

The phenomenon of backward pronominalization identified first by Williams (1997) adequately accounts for the behaviour of Greek pronouns presented in this paper. Consider the following data:

- (1) a. *Andrew* was expecting that *he* would get arrested.
- b. That *he* would get arrested, *Andrew* was expecting (it).

- (2) a. The fact that *she* lost the race disappointed *Jaelyn*.
 b. * It disappointed *JACLYN*, the fact that *she* lost the race.

According to Williams (1997) the antecedent has to either precede the pronoun as in (1), or when the pronoun precedes the antecedent, as in (2) it *must* be in a subordinate clause with respect to the antecedent. Anaphoric relations in this model are determined by linear precedence, not c-command. Thus, while Binding Theory is not enough to provide an inclusive analysis on the behaviour of Greek pronouns, Williams' generalization is.

This paper is structured as follows: In *Section 2* I present the basic assumptions I will be making use of concerning the syntactic structure of Greek, with special reference to verbal morphology and clitic placement. In *Section 3* I attempt to explain coreference with Greek pronouns through Binding Theory and establish that there are cases where co-indexing is not structurally determined, but is instead governed by linear order. I start *Section 4* by offering a short discussion on dependence and the relations between pronouns and antecedents based on their position in a structure. I then put Greek data through Williams' (1997) model to test whether dependence can sufficiently account for coreference relations in Greek. In this section I also demonstrate that Williams' model needs to be extended to account for the behaviour of Greek pronouns. Finally, in the discussion section (*Section 5*) I present a revision of Williams' (1997) generalization and in *Section 6* I conclude.

2 The Basics of Greek Syntax

For the purpose of this study we need to have some basic concepts regarding the syntax of Greek, a *pro*-drop language.

2.1 Complex Verbs in Greek

In this section I briefly discuss the morphology of Greek verbal clauses. Consider the following example:

- (3) *Telio* -s a- -me.
finish- ASP- TENSE AGR.
 'We are done/ finished'.

In example (3) the verb forms a complete sentence. The verb in Greek, apart from the root, contains a number of functional suffixes. *telio-* is the verbal root, *-s-* is an aspectual marker, *-a-* is the past tense marker, and *-me* is 1st person plural, which in this case is a covert subject, i.e. a *pro*. In languages with rich morphology like Greek, agreement morphology on verbs licenses and identifies null-subjects (Philippaki-Warbuton, 1987). The structural analysis developed in this paper is based on *The Mirror Principle* (Baker 1985: 375), according to which morphological derivations mirror syntactic derivations. Hence,

following Spyropoulos (1999) and Tsimpli (1990) among others, I am assuming that the verb raises to T after acquiring all functional affixes.

2.2 Pertaining SVO Order

Greek is generally accepted to underlyingly be a VSO language (Alexiadou, 1999; Alexiadou & Anagnostopoulou, 1998; Philippaki-Warbuton & Spyropoulos, 1999; Spyropoulos & Philippaki-Warbuton, 2001; Tsimpli, 1995). An SVO order is also highly common:

- (4) a. *ayapai* *o*¹ *Thomas* *tin* *podhlasia*.
love-PRES the_{NOM} Thomas_{NOM} the_{ACC} cycling_{ACC}
 ‘Thomas loves cycling.’
- b. *o* *Thomas* *ayapai* *tin* *podhlasia*.
the_{NOM} Thomas_{NOM} love-PRES the_{ACC} cycling_{ACC}
 ‘Thomas loves cycling.’

In (4a), the verb *ayapai* precedes the subject *o Thomas*, which in turn precedes the object *tin podhlasia*. In (4b), the verb *ayapai* is preceded by the subject *o Thomas*, and followed by the object *tin podhlasia*. Thus, a VSO order in (4a) is turned into an SVO order in (4b). For the purposes of this paper I will adopt Spyropoulos’ (1999) analysis (also in accordance with Panagiotidis & Tsiplakou, 2006), where a subject is generated under TopicP, heading its own projection. At Spec of vP we find a *pro* subject, which is linked to the overt subject via an A’-chain. The structure I assume for the subject-verb position in Greek is illustrated below:

(4b’)

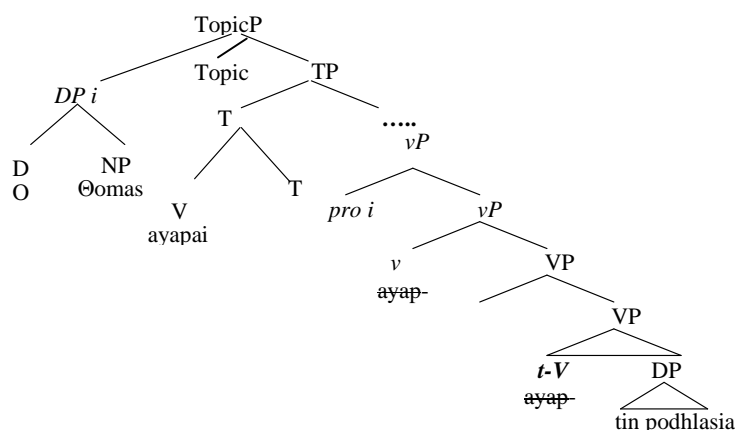

Since the pronouns used throughout this paper are strictly clitics I next examine clitic placement in Greek.

¹ Whatever case is assigned to the noun following the determiner is also assigned to the determiner.

2.3 Clitic Placement

In Greek, pronominal objects appear as preverbal clitics in an order [cl-v] as well as following the verb inside the VP in a [v-cl] order:

- (5) a. To forema skistike [sto spiti *tis*].
the dress_{ACC} rip off-PAST in-the house her_{GEN}
 ‘The dress got ripped off at her house.’
- b. To forema [*tis*] skistike sto spiti
the dress_{ACC} her_{GEN} rip off-PAST in-the house
 ‘The dress got ripped off at her house.’

Hegarty (1999) proposes that if N-features on Nominals are being checked against a functional head (e.g. AgrO) the clitic stays in its base-generated position following the verb, under VP, to surface [v-cl] order. If V-features are checked on the verb, the clitic moves up under TP, surfacing a [cl-v] order. In the set of data examined in this paper, clitics are placed after the verb and the overt object. As I am only examining post-verbal clitics in this paper, below you only see the structure for postverbal clitics:

(5')

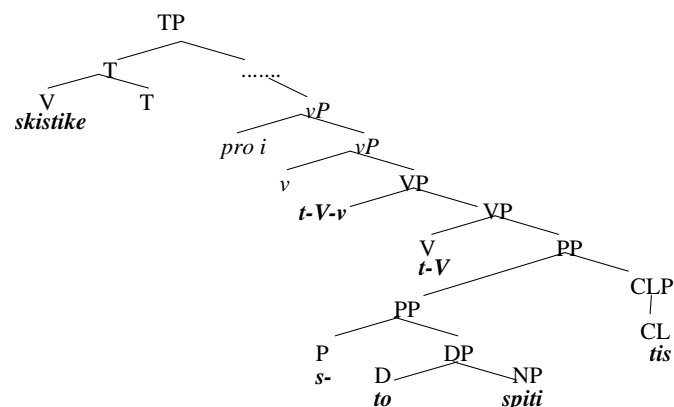

Hence, I am assuming that in these data, clitics remain in situ, following the verb and the DP-object (under PP, in this case), because N-features on the noun phrase are being checked. In the next section an analysis based on Binding Theory will be applied to account for the behaviour of Greek pronouns in terms of binding and coreference.

3 A Binding-Theoretic Analysis and its Problems

3.1 Data

The core contrast I am exploring in this paper is illustrated in (6a) – (6b):

- (6) a. i Tania₂ omoloyise oti [to forema pou Δanise *sti Yeoryia*₆]
the Tania admit_{PAST} that the dress_{NOM} which lend_{PAST} to-the Georgia_{ACC}
 [skistike sto spiti *tis*_{6/2}]
rip off_{PAST} in-the house her_{GEN}
 ‘Tania admitted that the dress she had lent to Georgia got ripped in her house.’
- b. i Tania₂ omoloyise oti [skistike sto spiti *tis*_{2/*6}]
the Tania admit_{PAST} that rip off_{PAST} in-the house her_{GEN}
 [to forema pou Δanise *sti Yeoryia*₆]
the dress_{NOM} which lend_{PAST} to-the Georgia_{ACC}
 ‘Tania admitted that the dress she had lent to Georgia got ripped in her house.’

It appears that, with Greek pronouns, a reading and hence the possibility of coreference is not available in a structure in which the clause that contains the pronoun precedes the clause that contains the antecedent. Specifically, in structure (6a), where the subordinate clause (a relative clause contained in a DP) precedes the matrix clause, the pronoun *tis* can be interpreted as referring to *Yeoryia*, i.e., coreference is allowed. In contrast, in (6b) the possibility of coreference between *tis* and *sti Yeoryia* is excluded. In the light of these data, the following question arises: what rules out coreference between *sti Yeoryia* and the pronoun (6b); what is it that allows the one in (6a)?

Given that coreference possibilities are assumed by standard to be regulated by Binding Theory (Chomsky 1981), I will first investigate whether Binding Theory can account for the pattern in (6a) and (6b). I next present some background information on Binding Theory, and on how those are described in the literature on Greek pronouns.

3.2 Binding Theory and Pronouns in Greek

In this section, before moving on to a Binding Theory analysis on the data examined in this paper, though, I present a few basic concepts on binding.

3.2.1 Basics on Binding

In a structure, α binds β if, and only if, α c-commands β and α and β carry the same index:

(7)

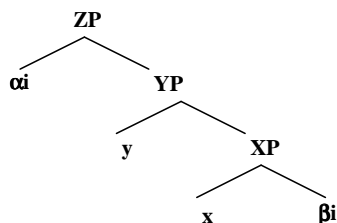

There are three binding conditions that determine coreference. *Binding Condition A* concerns reflexives and necessitates that a reflexive pronoun must be bound within its co-

argument domain. This condition however, is inconsequential to the present study because reflexives are not explored here. *Binding Condition B* requires that a non-reflexive pronoun be free in its co-argument domain (the smallest maximal projection XP that contains the NP, and the NP's case assigner (Büring, 2005:55, 120). Finally, for *Binding Condition C*, a full NP *must* be free in the root domain (i.e. the entire sentence) (Büring, 2005:112). For example, in the structural representation in (8), *Katie*, the full NP is the binder and the pronoun *her* is the "bindee." *Katie* binds the pronoun *her* because the two are co-indexed and the antecedent *Katie* c-commands the pronoun *tis*:

(8)

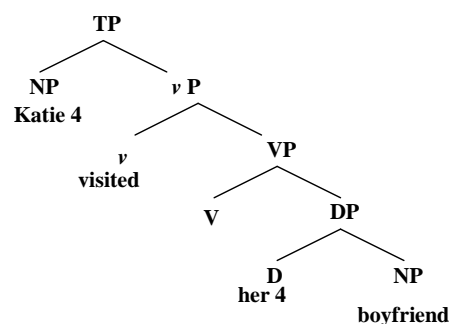

3.2.2 Data Analysis through Binding Theory

In this section I show that the data under investigation in this paper cannot adequately be analyzed in terms of Binding Theory. Pronouns in Greek have traditionally been analysed as conforming to the Binding Theory in terms of anaphoric reference (Iatridou, 1988; 1986). Iatridou makes use of the same definitions as above to determine Binding relations with pronouns in Greek. Through this research I now demonstrate that Binding Theory has nothing to say about examples (6a) and (6b), since neither Condition B nor C apply to either of the examples above. Since binding can only be established under c-command, Binding Theory cannot explain why coreference in (6b) is not available, while it is (allowed) in (6a). Following the definitions used in 3.2.1, I explain why neither Condition B nor C is relevant to the data examined in this paper. Starting with the sentence in (6a):

- (6) a. i Tania₂ omoloyise oti [to forema pou Δanise sti Yeorgia₆]
 the Tania admit_{PAST} that the dress_{NOM} which lend_{PAST} to-the Georgia_{ACC}
 [skistike sto spiti tis_{6/2}]
 rip off_{PAST} in-the house her_{GEN}
 'Tania admitted that the dress she had lent to Georgia got ripped in her house.'

Below is a structural representation for example (6a):

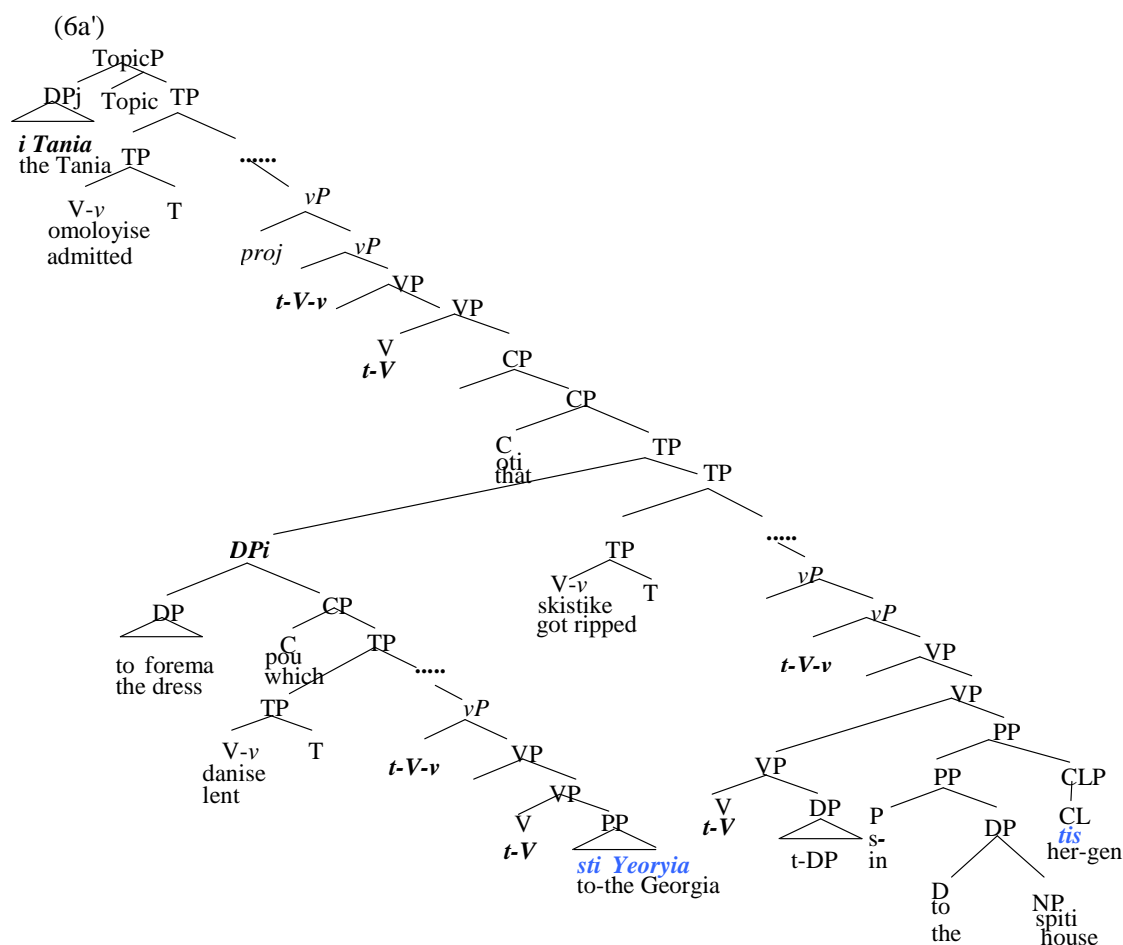

The matrix clause construction is passive. Therefore, the DP [*to forema pou* Δanise *sti Yeoryia*] is base-generated under VP, as a DP-object. Hence, the left-dislocated topic subject started off as an object of *skistike* ‘got ripped off’. The antecedent *Yeoryia* under *t-DP* object does not c-command the clitic *tis* under PP, though it precedes it. Thus, a c-command relation is not established because even though neither *Yeoryia* dominates *tis* nor *tis* dominates *Yeoryia*, the maximal projection that dominates *Yeoryia* does not dominate *tis*. According to the Binding theory definition, binding can only occur when an NP phrase both c-commands and binds another. Therefore, neither Binding Condition B nor C applies in this case. Thus, the antecedent *Yeoryia* is free in the root domain. Moreover, *Tania* c-commands the pronoun *tis*, because the maximal projection that dominates *Tania* also dominates *tis*, and neither of the two dominates each other.

I now examine whether the change in the positioning of the two clauses also alters the coreference relation between pronoun and antecedent, and thus Binding Theory can indeed explain why coreference in (6b) is eliminated.

- (6) b. i Tania₂ omoloyise oti [skistike sto spiti *tis*_{2/*6}]
 the Tania admit_{PAST} that rip off_{-PAST} in-the house her_{GEN}

[to forema pou Δanise *sti* *Yeorgia*₆]
 the dress_{NOM} which lend_{PAST} to-the Georgia_{ACC}

‘Tania admitted that the dress she had lent to Georgia got ripped in her house.’

Next is a structural representation for (6b):

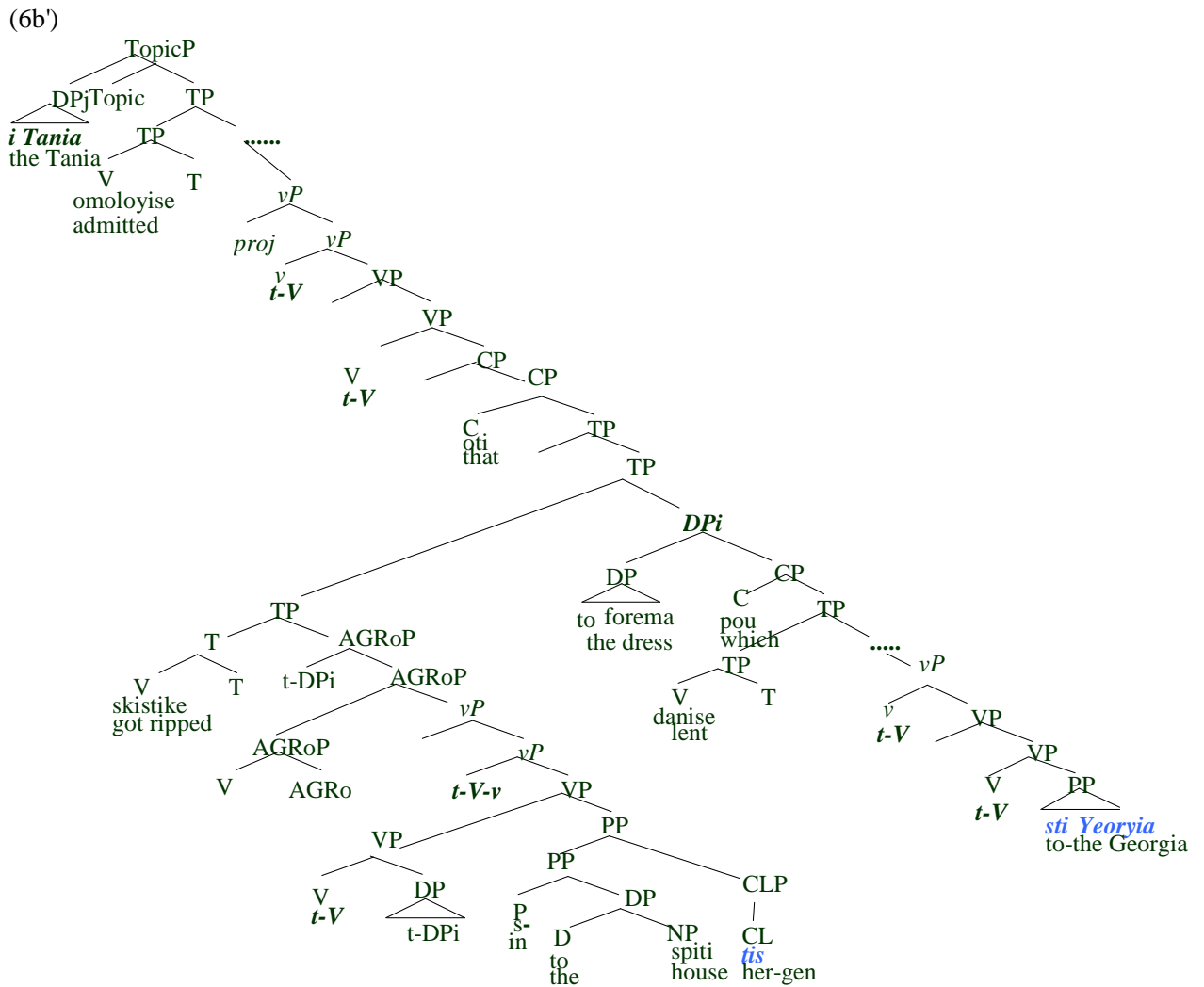

Following the same argumentation as above, c-command between *Yeorgia* and *tis* does not apply because despite the fact that neither of the two dominates the other, similarly to

(6a'), the maximal projection VP that dominates *tis*, does not also dominate the antecedent *Yeorgia*, nor does the maximal projection PP that dominates *Yeorgia* also dominate *tis*². Thus, Binding Condition B does not apply for the pronoun, nor does Binding Condition C apply for the antecedent. Since there is no offending binder to block the coreference between *tis* and *Yeorgia* Binding Theory cannot explain why the relation is excluded in (6b). To sum up, Binding is not able to account for the distinction between (6a) and (6b), in which the same conditions should apply. After considering the structural configurations above the following questions arises: what else could be responsible for the observed pattern? If Binding Theory cannot account for the contrast between (6a) and (6b), then what else could be responsible for this contrast?

A search for an alternative which can determine coreference relations established in these examples is called for. Based on the assumption that all co-reference possibilities are structurally conditioned, Greek data were examined under such analysis (i.e. Binding Theory). However, that possibility is excluded by the argumentation on the structural representations (6a') and (6b') above.

Observing the data above, I suggest that coreference is made available in terms of linear precedence. An analysis in terms of precedence can explain the co-indexing between the pronoun and its antecedent in (6a) and the unavailability of co-indexing in (6b). In (6a) the full NP precedes the pronoun; hence, the pronoun gets its reference from the antecedent that comes earlier in the sentence. In (6b) the pronoun precedes its antecedent, and therefore the pronoun does not have a referent since precedence requires a full NP to always precede a pronoun in order for the two to be co-indexed. However, this hypothesis also makes the wrong prediction; precedence is not enough to explain the availability of a grammatical co-indexing in the following example:

- (9) i Tania₂ omoloyise oti [to forema pou *tis*_{2/6} Δanise]
 the Tania admit_{PAST} that the dress_{NOM} which her_{GEN} lend_{PAST}
 skistike sto spiti *tis* *Yeorgias*₆
 rip off_{PAST} in-the house the Georgia_{GEN}
 'Tania admitted that the dress she had lent to Georgia got ripped in her house.'

In (9) the antecedent follows the pronoun, and yet the co-indexing of the two surfaces as grammatical. After considering a Binding Theory as well as a precedence analysis, it seems that in these Greek examples relations are neither established in terms binding/ c-command, nor a general analysis based on precedence. In conclusion, binding cannot explain the discrepancy observed between (6a) and (6b). Moreover, precedence alone can indeed account for the pattern in (6a) – (6b), but not the availability of co-indexing in (9). Thus, since Binding Theory which traditionally modifies coreference possibilities cannot explain the

² Coreference between *Tania* and *tis* is not discussed here because the relation between the two is parallel to the one discussed above.

phenomenon exhibited in (6a), (6b) and (9), an alternative analysis based on linear precedence is pursued.

4 Alternative Analysis: Backward Dependence/ Pronominalization

Williams (1997) discusses English data comparable to (6a) and (6b) and analyzes them in terms of anaphoric dependence. He clarifies that while dependence is defined in terms of linear precedence, coreference is governed by c-command and licensed based on the Binding Theory (1997:589).

4.1 What is dependence?

Concerning pronouns and antecedents, a pronoun gets its meaning by *depending* on an antecedent, before any reference to the actual individual is made. Hence, in an example like:

- (10) a. Laura_i saw herself_i³
- 

the reflexive initially gets its reference from the antecedent, which *must* be a proper name, or a full DP with a common N, which then in turn refers to the actual person:

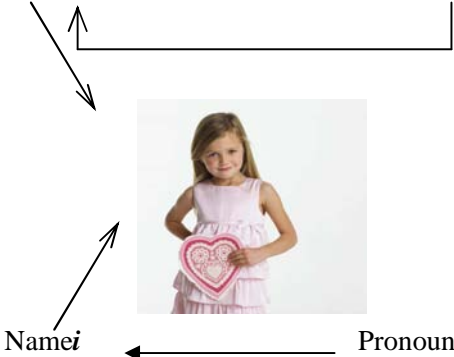
- (10) b. Laura_i saw herself_i
- 

4.2 Forward vs. Backward Dependence and important details

Williams (1997) suggests two types of dependence: forward and backward dependence. With forward dependence any structural relation is permitted. The pronoun can either be in a

³ A reflexive, instead of a non-reflexive pronoun is used here because it is easier to demonstrate dependence. Dependence, though, operates, the same way for non-reflexives in Greek, as the reflexive here.

matrix (11a)⁴ or subordinate clause (11b) with respect to the antecedent, so long as the clause with the antecedent precedes the clause with the pronoun.

- (11) a. Anyone can turn *his term paper*₆ in to me now [who has written *it*₆].
 b. Anyone [who has written *his term paper*₆] can turn *it*₆ in to me now.

In the case of backward dependence, the pronoun must be in a *subordinate* clause relative to the antecedent, and the subordinate clause has to precede the clause which contains the antecedent. Backward dependence has also been described as backward pronominalization because the antecedent is “pronominalized backward” to provide a referent to a pronoun⁵:

- (12) Anyone [who has written *it*₆] can turn *his term paper* in to me now.

Furthermore, if the pronoun is within a matrix clause and the antecedent following is in a subordinate clause and is additionally focused, then co-indexing is not applicable, and in most cases it results to an ungrammatical structure (Williams, 1997:588):

- (13) *Anyone can turn *it*₆ in to me now [who has written his TERM PAPER⁶].

According to Williams (1997) focus can block the co-indexing of a pronoun with its referent. If the antecedent is focused it means that it is new information. When the antecedent is stressed, it furthermore implies that a previously established discourse referent is not available, since the one in the structure (following the pronoun) receives focus or main sentence stress because it is introduced in the structure for the first time. However, if the antecedent is de-accented and the verb next to it receives main sentence stress, the reading becomes available:

- (14) Anyone can turn *it*₆ in to me now [who has WRITTEN *his term paper*₆].

As stated by Selkirk’s (1984) anaphoric destressing analysis, when a verb receives stress, it is because the nominal element, the complement of the verb, has been destressed. This is observed above where co-indexing of pronoun and antecedent is “unblocked” once stress is shifted to the verb. This change presupposes that there is an antecedent within context (i.e. discourse referent) that is exactly the same as the one in the structure, following the pronoun (Williams, 1997). The de-accenting rule applies to all the data presented in this paper and provides the same results as the ones illustrated above. In sum, Williams formulates the *general pattern of anaphoric dependence* (hereinafter, GPAD) to capture how in a pronoun-antecedent relation, in five patterns where c-command is not available, forward as well as

⁴ Examples (11) through (14) are all taken from Williams (1997).

⁵ Henceforth, the two terms backward dependence and backward pronominalization will be used interchangeably.

⁶ Hereafter capitalization of the antecedent indicates that it receives main sentence stress.

I now apply the other two configurations of the GPAD to these data. I expect that all five structural configurations of the GPAD with Greek pronouns surface parallel to English.

- (16) c. [...pro ...]_{subord} matrix [...antec...]
 i Tania₂ omoloyise oti [to forema pou *tis*_{2/6} Δanise] skistike sto spiti *tis* *Yeoryias*₆]
the Tania admit_{PAST} that the dress_{NOM} which her_{GEN} lend_{PAST} rip off_{-PAST} in-the house the Georgia_{GEN}
 ‘Tania admitted that the dress she had lent to Georgia got ripped in her house.’
- d. [...antec ...]_{matrix} [...pro...]_{subord}
 i Tania₂ omoloyise oti [skistike sto spiti *tis* *Yeoryias*₆] [to forema pou *tis*_{2/6} Δanise]
the Tania admit_{PAST} that rip off_{-PAST} in-the house the Georgia_{GEN} the dress_{NOM} which her_{GEN} lend_{PAST}
 ‘Tania admitted that the dress she had lent to Georgia got ripped in her house.’

The five structures in (16) illustrate that both forward (16a & d) and backward (16c) dependence are also observed in Greek. As expected from the generalization of anaphoric dependence formed in Williams (1997), (16b) yields an ungrammatical co-indexing of *tis* and *sti Yeoryia* because the pronoun apart from preceding the antecedent is in a matrix clause, not a subordinate one, it is furthermore stressed. By de-accenting the antecedent, and placing main sentence stress on the verb next to it, as in (14), the reading becomes available. The same is also observed with (16e) below:

- (16) e. [... pro ..]_{matrix} subord [... antec ...]
 i Tania₂ omoloyise oti [skistike sto spiti *tis*_{2/*6}] to forema pou Δanise *sti* *Yeoryia*₆.
the Tania admit_{PAST} that rip off_{-PAST} in-the house her_{GEN} the dress_{NOM} which lend_{PAST} to-the Georgia_{ACC}
 ‘Tania admitted that the dress she had lent to Georgia got ripped in her house.’

It appears from the examples above that forward and backward pronominalization can explain the behaviour of Greek pronouns, with which co-indexing is determined in terms of linear order and not c-command relations.

4.3.2 The GPAD with V– argument – adjuncts

In this section I demonstrate that the GPAD also applies to adjunct–argument structures and not exclusively to matrix – subordinate clauses, for which the GPAD is originally designed. The original idea of the GPAD as presented in Williams (1997) applies only to bi-clausal sentences in which one clause serves as the matrix clause, and the second as the subordinate or embedded clause. Here I show that the GPAD must be broadened to include argument–adjuncts besides bi-clausal sentences. The following examples illustrate that the generalization above holds and the GPAD in addition to bi-clausal sentences, can also extend to sentences in which pronoun and antecedent are not located in clauses, but rather a V–argument and an adjunct. As with (16) the sentences below include two antecedents⁸:

⁸ Similarly to the examples in (16), a Binding Theoretic analysis was attempted for (17) as well, but as with (16) Binding cannot be applied to account for the coreference relations between pronoun and antecedent here either.

Context: Lisa met Martina once before at a gallery exhibition.

(17) a. [... antec ...] adjunct [... pro ...] argument
 i Liza₈ [vrike [sto portofoli tis **Christinas**₆] [mia fotoyrafia **tis**_{8/6/4}]
the Lisa_{nom} find_{past} in-the wallet_{acc} the Christina_{Gen} one_{acc} picture_{acc} her_{Gen}
 ‘Lisa found a picture of her in Christina’s wallet.’

(17) b. [... pro ...] adjunct [... antec ...] argument
 i Liza₈ vrike [sto portofoli **tis**] [mia fotoyrafia **tis** **Christinas**₆]
the Lisa_{nom} find_{past} in-the wallet_{acc} her_{Gen} one_{acc} picture_{acc} the Christina_{Gen}
 ‘Lisa found a picture of Christina in her wallet.’

(17) c. [... antec ...] argument [... pro ...] adjunct
 [i Liza₈ vrike [mia fotoyrafia **tis** **Christinas**₆] [sto portofoli **tis**]
the Lisa_{nom} find one_{acc} picture_{acc} the Christina_{Gen} in-the wallet_{acc} her_{Gen}
 ‘Lisa found a picture of Christina in her wallet.’

(17) d. * [... pro ..] argument [... antec ...] adjunct
 [i Liza₈ vrike mia [fotoyrafia **tis**_{8/4/*6} [sto portofoli tis **CHRISTINAS**₆.]]
the Lisa_{nom} find_{past} one_{acc} picture_{acc} her_{Gen} in-the wallet_{acc} the Christina_{Gen}
 ‘Lisa found a picture of her in Christina’s wallet.’

As the data set in (17) demonstrates, the GPAD is also observed with argument–adjuncts in addition to sentences with matrix and embedded clauses. Specifically, both *Lisa* and *Christinas* can be co-indexed and thence serve as referents to the pronoun *tis* for all three of (17a), (17b) and (17c). In the case of (22d), the co-indexing of the antecedent *CHRISTINAS* and clitic *tis* is barred, as predicted by the GPAD. However, as with the bi-clausal sentences, when the antecedent is de-accented co-indexing is possible:

(17) e. [... pro ..] argument [... antec ...] adjunct
 i Liza₈ vrike [MIA FOTOYRAFIA **tis**_{8/4/6} [sto portofoli tis **Christinas**₆.]]
the Lisa_{nom} find_{past} one_{acc} picture_{acc} her_{Gen} in-the wallet_{acc} the Christina_{Gen}
 ‘Lisa found a picture of her in Christina’s wallet.’

V–argument–adjunct sentences such as the preceding are comparable to a matrix–subordinate clause sentences in terms of the GPAD. In order for the GPAD to apply grammatically to argument–adjunct sentences, the pattern needs to be reformed in the following way: the V–argument that is necessary for the grammaticality of the sentence, serves as the “matrix clause.” This part of the sentence carries the meaning which is paramount to the grammaticality of the structure. The adjunct functions in the same way as an embedded clause, such that it provides supplementary information to the sentence. Thus, the five configurations with matrix–subordinate sentences set up by Williams, presented in section 4.2, surface comparatively to V–argument –adjuncts. Therefore, it is concluded that

an extended GPAD modified in this section can be applied to Greek pronouns in V-argument-adjunct structures as well. In the table below I summarise the two environments the GPAD is found:

Table 1

The General Pattern of Anaphoric Dependence with Greek Pronouns

Williams (1997)	C	Extended (present paper)	C
[pronoun] _{subord} [antecedent] _{matrix}	✓	[pronoun] _{adjunct} [antecedent] _{argument}	✓
[antecedent] _{subord} [pronoun] _{matrix}	✓	[antecedent] _{adjunct} [pronoun] _{argument}	✓
[antecedent] _{matrix} [pronoun] _{subord}	✓	[antecedent] _{argument} [pronoun] _{adjunct}	✓
[pronoun] _{matrix} [ANTECEDENT] _{subord}	×	[pronoun] _{argument} [ANTECEDENT] _{adjunct}	×
[pronoun] _{matrix} [antecedent] _{subord}	✓	[pronoun] _{argument} [antecedent] _{adjunct}	✓
C: Co-indexing allowed			

5 Discussion and Implications

5.1 Analyses Compared

In *Section 3* I established that Binding Theory, the module of grammar that determines coreference relations, is not sufficient to account for the Greek data presented in this paper. Though binding can be applied in many other cases with Greek pronouns, it is nevertheless not enough to explain the entire extent of all pronouns and their anaphoric relations. After applying Binding Theory to the Greek data examined in this paper, I have demonstrated that neither *Binding Condition C* nor *Binding Condition B* apply to exclude the reading in (6b). In addition, the fact that coreference in (6a) is not excluded, though it occurs in the same environment as in (6b), drove this research to consider an alternative based on precedence.

An attempt to explain the data in (6a) and (6b) through general precedence terms was made. I illustrated that in (6a), where the antecedent precedes the pronoun, coreference is indeed allowed. On the other hand, in (6b) where the pronoun precedes the antecedent, the reading is excluded. I have shown that, though precedence is initially perceived as adequate to provide a satisfactory description for the Greek pronouns in these data, it later becomes clear that precedence alone is insufficient to explain examples like (9), where the antecedent precedes the pronoun and co-indexing is yet allowed. The general conclusion for *Section 3* and the Binding Theory analysis is that only an alternative approach, based on linear precedence, is suitable for determining co-indexing with *these data*.

The alternative approach selected for the analysis of Greek pronouns follows Williams (1997), where he explains English data comparable to (6a) and (6b) in terms of anaphoric dependence. Hence, in *Section 4* I demonstrated that the *General Pattern of Anaphoric Dependence* and the analysis on accented and de-accented clauses can satisfactorily determine anaphoric relations with data examined in this section. While binding has nothing to say about (6a) and (6b), dependence does. (6a) is perceived as forward dependence such

that if a pronoun precedes an antecedent (whether in a matrix or subordinate clause), co-indexing is allowed. (6b) is explained in terms of backward dependence, which states that if a pronoun in a subordinate clause precedes an antecedent in a matrix clause, co-indexing is available. If, however, the antecedent is focused and positioned in a subordinate clause preceding the pronoun in a matrix clause as in (6b), then co-indexing is excluded. The “de-accenting rule” accompanying this analysis predicts that by de-accenting the antecedent in the second case of backward pronominalization mentioned above and applying main sentence stress on the *verb* instead of the antecedent, co-indexing becomes available. Williams (1997) and Selkirk (1984) explain that stress shift from the antecedent to the verb makes the reading described above grammatical/available. De-accenting of the antecedent makes the reading available because it presupposes the existence of an antecedent in discourse which has been introduced before the pronoun *and* the antecedent in the structure.

5.2 Implications of Williams’ (1997) GPAD model

Backward dependence does not necessarily occur exclusively with matrix and subordinate clauses. In *Section 4* of this paper I have established that Williams’ GPAD model as is, does not apply to all sentences that backward dependence is found. Therefore, the model needs to be extended to include a greater variety of data. Since the same phenomenon is observed with V-argument-adjuncts, the GPAD needs to be revised to include data like in (17). The five configurations for the revised version of the model now are:

- (18) a. [...pro ...]_{subord-XP} [...antec ...]_{primary -XP}
 b. [...antec ...]_{primary -XP} [...pro ...]_{subord-XP}
 c. [...antec ...]_{subord-XP} [...pro...]_{primary -XP}
 d. *[... pro ..]_{primary -XP} [...ANTEC...]_{subord-XP}
 e. [... pro ..]_{primary -XP} [...antec...]_{subord-XP}

The clauses, adjuncts and V-arguments should be considered as primary and secondary (or embedded) XPs. A Primary XP is comparable to Williams’ matrix clause as well as (17)’s V-argument. A secondary or embedded XP is comparable to (17)’s adjunct, in addition to Williams’ subordinate clause. By extending the model and revising the terminology used by Williams (1997), the *Revised General Pattern of Anaphoric Dependence (R-GPAD)* is able to cover more data exhibiting backward as well as forward dependence. Below is the revised definition for backward dependence/ pronominalization:

Backward Pronominalization (revised): if a pronoun is in a secondary XP (i.e. a subordinate clause or an adjunct), and the antecedent follows in a primary XP (i.e. a matrix clause or a verb complement), the two can be co-indexed. However, if the pronoun preceding the antecedent is positioned in a primary XP and receives main sentence stress, then co-indexing is excluded.

6 Conclusions

The research developed in this paper establishes that a Binding Theory analysis is not adequate to account for the behaviour of the entire extent of pronouns in Greek or English as Williams (1997) demonstrates. Instead, coreference relations for the data presented in this paper are determined in terms of linear precedence, not c-command. Therefore, it is not too bold to suggest that, after considering the data examined in this paper, a revision of how coreference relations are decided in Binding Theory is called for.

Concerning Williams' (1997) anaphoric dependence model, this paper establishes that an extension is needed in order to include the whole extent of pronoun behaviour. In particular, in Greek co-indexing is not limited to pronouns and antecedents in (matrix and subordinate) clauses. In addition to those, a pronoun and an antecedent in a verb argument and adjunct can also exhibit forward and backward dependence.

In further research it can also be tested whether backward pronominalization and the *R-GPAD* in general, extends to sentences with strong pronouns in Greek as well as a covert pronoun (i.e. *pro*) and an overt antecedent, not only for Greek, but other *pro*-drop languages.

In conclusion, this paper makes three main contributions. First, it confirms that Binding Theory cannot account for all antecedence/anaphoric relations between pronouns (or *pro*) and NPs. Second, Williams' (1997) GPAD was found to be more specific than anaphoric relations in Greek require a model that determines dependence relations to be. Thus, this research offered sufficient information and has broadened the model so it covers a greater extent of data. Finally, it has made a contribution to the literature on Greek pronouns, which have thus far been perceived only in terms of binding and c-command. As evident from the lack of literature, the phenomenon of backward pronominalization is a considerably understudied phenomenon, not only in Greek, but also other languages. This research has therefore also added to the literature on backward pronominalization and dependence relations in general.

Acknowledgments

Thanks to Dr. Martina Wiltschko for supervising this study and challenging all of my preliminary analyses on the subject.

Thanks to the Department of Foreign Affairs and International Trade, Canada, for sponsoring this research as well as my PhD degree.

References

- Alexiadou, Artemis. (1999). "On the Properties of some Greek Word Order Patterns". In *Studies in Greek syntax*, ed. by Artemis Alexiadou, Geoffrey Horrocks, and Melita Stavrou, 45–65. Dordrecht: Kluwer.
- Alexiadou, Artemis, and Elena Anagnostopoulou. (1998). "Parametrizing Agr: Word order, V-movement and EPP-checking". *Natural Language & Linguistic Theory* 16:491–539.
- Baker, Mark. (1985). "The Mirror Principle and Morpho-syntactic Explanation". *Linguistic Inquiry* 16: 373-415.
- Büring, Daniel. (2005). *Binding Theory*. CUP Press, Edinburgh, UK.
- Chomsky, N. (1981): *Lectures on Government and Binding*. Dordrecht: Foris.
- Hegarty, Michael. (1999) "Clitic Placement and the Projection of Functional Categories". In *Studies in Greek syntax*, ed. by Artemis Alexiadou, Geoffrey Horrocks, and Melita Stavrou, 135–152.
- Iatridou, Sabine. (1986). "An Anaphor not Bound in its Governing Category", *Linguistic Inquiry* 17:766-772.
- Iatridou, Sabine. (1988). "Clitics, Anaphors, and a Problem of Coindexation", *Linguistic Inquiry* 19: 698-703.
- Panagiotidis, Phevos and Stavroula Tsiplakou. (2006). "An A-Binding Asymmetry in Null Subject Languages and its Significance for Universal Grammar". *Linguistic Inquiry* 37: 167-177.
- Philippaki-Warbuton, Irene. (1987). "The Theory of Empty Categories and the pro-drop Parameter in Greek". *Journal of Linguistics* 23:289–318.
- Philippaki-Warbuton, Irene, and Vassilios Spyropoulos. (1999). Simfonia ke Ipokimeno stin Eliniki: Ipothesi Asinehus Ipokimenu (Agreement and subject in Greek: Discontinuous subject hypothesis). In *Greek Linguistics '97: Proceedings of the 3rd International Conference on the Greek Language*, ed. by Amalia Moser, 324–332. Athens: Ellinika Grammata.
- Selkirk, Elisabeth. (1984). *Phonology and Syntax*. Cambridge, Mass.: MIT Press.
- Spyropoulos, Vassilios. (1999). *Agreement Relations in Greek*. Doctoral Dissertation, University of Reading, UK.
- Spyropoulos, Vassilios, and Irene Philippaki-Warbuton. (2001). " 'Subject' and EPP in Greek: The discontinuous subject hypothesis". *Journal of Greek Linguistics* 2:149–186.
- Tsimpli, Ianthi-Maria. (1990). "The clause structure and word order of Modern Greek". In *UCL working papers in linguistics 2*, ed. by John Harris, 226–255. London: University College London, Department of Phonetics and Linguistics.
- Tsimpli, Ianthi-Maria. (1995). "Focusing in Modern Greek". In *Discourse configurational languages*, ed. by Katalin É. Kiss, 176–206. New York: Oxford University Press.
- Williams, Edwin. (1997). "Blocking and Anaphora". *Linguistic Inquiry* 28, 577 -617.

Not Does More than What the Truth-Functional Negation can Do

Yasuhiro Sasahira

University of Wisconsin-Madison
ysasahira@gmail.com

ABSTRACT

This paper investigates a semantic property of sentential negation and a syntax-semantics interface property of lexical aspect and the way sentential negation interacts with it. I show that a puzzling property of negative sentences, namely that they display the sub-interval property without affecting the aspectual property of the predicate involved, is accounted for by giving sentential negation a more sophisticated structure than what is generally assumed.

Building on Rothstein's (1999) mass-count distinction in the eventuality domain, I show that VPs denote relations between count and mass eventualities such that the former instantiates the existence of the latter and that each of the four Vendlerian aspectual classes is defined in terms of the instantiation of the particular type of mass eventualities that are realization of aspectual features.

Keywords: lexical aspect; mass-count distinction; sentential negation; situations.

1 Introduction

This paper examines the semantics and the syntax-semantics interface properties of sentential negation and elements in the verbal domain, namely, Adjective Phrases (APs) and Verb Phrases (VPs) in English. The goal of this paper is to investigate the aspectual properties of the VP and the way sentential negation interacts with them. I show that semantically a Larsonian VP shell is structured in such a way that the denotation of the lower VP is found in the mass domain while that of the upper VP is found in the count domain. This is based on Rothstein's (1999) analysis of the '*be* + AP' structure, where the denotation of AP is found in the mass domain and the function of *be* is to instantiate a set of mass-eventualities denoted by the AP. I show that the denotation of the negative operator is found in the mass-domain on a par with the denotation of AP. In particular, sentential negation has a universal quantificational force whose quantificational structure shares an important property in common with that of 'universal' adjectives as defined by Kamp and Rossdeutscher (1994), where a universal adjective *healthy* denotes a set of individuals x such that for every ailment w , if there is any, x is in a state of being cured of w .

The generalization that is derived from this analysis is that the universal quantifier associated with a universal adjective and the negative operator take pre-states as the domain of quantification and the corresponding result-states as their scope. For example, the negative sentence ‘There aren’t stains on the table’ denotes the relation between the set of pre-states (i.e., a set of states that instantiate the existence of stains on the table) and a set of the corresponding result-states (i.e., a set of states obtained as the result of stains becoming non-existent) such that every such pre-state, *if there is any*, is extendable to the corresponding result-state. The non-existential commitment of the domain of quantification as emphasized in italics is shown to follow from the essential nature of the universal quantification involved in the semantics of sentential negation, where a pre-state constitutes an essential or necessary condition for the corresponding result-state to hold. The nature of the pre-state associated with the semantics of sentential negation is made sensitive to the way the state associated with each type of predicate is realized.

With this mechanism, we can satisfactorily account for a puzzling fact about negative sentences, namely, the sub-interval property expressed by a negative sentence leaving intact the aspectual property of the predicate the negative operator is associated with. This proposal also provides a satisfactory account of why negative sentences are generally more context-dependent than their affirmative counterparts. The non-existential commitment on the domain of quantification indicates that what is under discussion in a discourse context is whether the set of pre-states that constitute the domain of the negative operator is empty or non-empty. This explains in a principled manner the context-dependency of negative sentences often discussed in the literature (e.g., Horn 1989), namely that a negative sentence ‘presupposes’ the corresponding affirmative sentence without actually presupposing it.

2 Sentential negation and context dependency: semantics or pragmatics?

2.1 Context dependency as a consequence of speaker denials to assertions

As has often been discussed in the literature (Givon 1978, Horn 1989, among others), negative sentences are more context-dependent than their affirmative counterparts. For example, in the following sentences, the negative sentence in (1a) is interpreted as if its affirmative counterpart (1b) is already in discourse:

- (1) a. My wife isn’t pregnant.
 b. My wife is pregnant. (Givon 1978)

If (1a) is uttered in a context where the listener doesn’t know whether the speaker’s wife is pregnant, the listener’s likely response will be: ‘Oh, I didn’t know that your wife was supposed to be pregnant’. In contrast, the affirmative counterpart (1b) is perfectly fine when it is uttered in a discourse-initial context.

The context-dependency just mentioned above is generally considered to be a conversational implicature (Horn 1989, among others) and as such it is not part of the

semantics of sentential negation. I challenge this conclusion and argue that sentential negation is inherently modal. If sentential negation is inherently modal, then the context dependency just discussed follows naturally without stipulation. In what follows, I present two pieces of evidence to show that sentential negation is inherently modal and hence that the context dependency just discussed is part of the semantics of sentential negation.

2.1.1 *The essential nature of negation*

The term ‘essential’ implies that there is a relation between A and B such that the relation between them is essential. In this way, ‘essential’ is a relational notion and the relation is an asymmetric one. The essential nature of negative sentences implies that negative sentences must denote some type of asymmetric relation. Since essential quantification is non-factual in the sense that it does not commit itself to the existence of the members of the domain of quantification, the essential nature of negative sentences motivates a modal analysis of negation.

Dayal (1998) makes a distinction between the two types of universal quantification—*accidental* and *essential*. The characteristic distinction between the two types she notes is the distinction in the ‘existential commitment’, where the accidental quantification commits itself to the existence of the members of the domain of quantification whereas the essential quantification lacks the existential commitment. To see this, consider the following example from Dayal (1998):

- (2)
- a. Every student in Mary’s class is working on polarity items.
 - b. It happens to be true of every student in Mary’s class that he/she is working on polarity items.
 - c. Every student in Mary’s class, by virtue of being in her class, is working on polarity items.

She notes that this sentence is ambiguous between a reading in which membership in the set denoted by the relative clause is accidental and one in which it is essential to the truth of the statement being made. The distinction is reminiscent of the distinction Donnellan (1966) makes between referential and attributive uses of definite descriptions.

According to Dayal, the ambiguity disappears when the phrase *whoever they may be* is added after the modified noun phrase, which isolates the essential reading as in (3a), while the addition of the accidental predicate *happen to* to the main predicate isolates the accidental reading as in (3b):

- (3)
- a. Every student in Mary’s class, *whoever they may be*, is working on polarity items.
 - b. Every student in Mary’s class *happens to* be working on polarity items.

As Dayal notes, the combination of the phrase *whoever they were* and the accidental predicate *happen to* in (3a) or the addition of the phrase *whoever she may be* after the modified noun phrase of a sentence whose preferred reading is the accidental one as in (3b)

leads to ungrammaticality:

- (4) a. *Every student in Mary's class, *whoever they were*, happened to vote for the Republican.
 b. *Every woman standing under that tree, *whoever she may be*, is Mary's best friend.

Interestingly, negative sentences allow only the essential readings. Consider the following examples:

- (5) a. *Whatever the situation was*, Peter didn't eat Mary's cookies.
 b. Mary didn't *happen to* eat Mary's cookies.
 c. It *happened to* be true of Peter that he didn't eat Mary's cookies.

(5a) shows that the negative sentence is compatible with the *whatever* phrase, indicating the essential nature of the sentence. (5b) can only have the reading where the accidental predicate *happen to* is interpreted outside the scope of negation as paraphrased in (5c). The fact observed in (5b) indicates that negation somehow makes the content that is negated essential. In other words, while a negative sentence itself can be accidental, negation cannot be.

Another feature of essential quantification is its non-existential commitment or contextual vagueness on the domain of quantification. The following example illustrates the point. In this example, the nature of the set of soldiers who had fought in the Gulf War is left vague:

- (6) We didn't keep the list of names, but the President thanked every soldier who had fought in the Gulf War. (Dayal 1998)

Negative sentences also exhibit a similar type of vagueness, as the following example suggests:

- (7) I'm not sure of the status of the package, but the package didn't arrive.

In this example, the speaker is uncommitted as to the status of the package---whether it is on the way to be delivered or not. In section 4, I will show that the non-existential commitment or contextual vagueness is the heart of the semantics of sentential negation, in the sense that it characterizes the semantic nature of the domain restriction of sentential negation.

2.1.2 *Modal subordination*

The second piece of evidence to motivate a modal analysis of negation is that a negative sentence can host an inter-sentential anaphora in non-factual contexts. Consider the following examples:

- (8) a. Peter might have bought a Porsche₁.
 b. There isn't anyone who saw him driving it₁, though.
 c. #There is someone who saw him driving it₁.

In (8), the pronoun *it* in (8b) can be anaphorically linked to the indefinite *a Porsche* without assuming that Peter actually bought a Porsche or that there is a Porsche that Peter is associated with. In contrast, (8c) can be felicitously uttered only if there is a Porsche that Peter is associated with. Then (8c) can be used as evidence for the possibility that Peter bought the car, and didn't just borrow it from someone. In other words, on this reading, there is a Porsche that has something to do with Peter and what is at issue is whether Peter bought it or not.

The phenomenon just discussed has been known as *modal subordination* since Robert's (1989) work on this topic. It is called *modal subordination* because in the felicitous cases in the above examples the (b) sentences may be interpreted as a sort of continuation of the (a) sentences without committing the speaker to the existence of a Porsche in (8a).

According to Roberts, the successful anaphoric linkage crucially relies on the mood of an utterance that tells us whether or not it is asserted. For instance, in the following examples (cited from Roberts 1989), the pronoun *it* in (9b) cannot be anaphorically linked to the indefinite *a book* in the antecedent of the conditional, whereas such linkage is possible in (10b):

- (9) a. If John bought a book₁, he'll be home reading it₁ by now.
 b. #It₁ is a murder mystery. (Roberts 1989)
- (10) a. If John bought a book₁, he'll be home reading it₁ by now.
 b. It₁'ll be a murder mystery. (Roberts 1989)

Roberts assumes that if a speaker indicates that a sentence or clause is to be interpreted as true in the actual world, the sentence or clause must be uttered in the factual mood whereas if a clause like the antecedent of a conditional expresses a hypothetical assumption, it must be uttered in a nonfactual mood. According to this criteria, the contrast between (9) and (10) is the contrast in mood: that is, (9b) is uttered in a factual mood whereas (10b) is in a nonfactual mood.

Roberts considers two approaches to account for the successful anaphoric linkage illustrated in (10). One is the *Insertion Approach*, in which the material that contains an anaphoric pronoun is inserted in the scope of the modal operator that contains the antecedent indefinite. The other is the *Accommodation of the Missing Antecedent Approach*, in which the material that contains the antecedent indefinite is accommodated in the restrictor of the modal operator that contains the anaphoric pronoun. Based on the following example, Roberts adopts the latter approach:

- (11) a. A thief might break into the house.
 b. He would take the silver. (Roberts 1989)

According to the *Insertion Approach*, the material in (11b), namely, ‘he take the silver’, is inserted (i.e., conjoined with) into the scope of the modal *might* in (11a). However, this would yield the wrong truth-condition since *might* is existential whereas *would* is universal. On the other hand, the *Accommodation of the Missing Antecedent Approach* yields the correct truth-condition since in this case the material that contains the antecedent indefinite ‘a thief break into the house’ is accommodated into the implicit restriction of the modal *would*.

Viewed in this way, the fact that negative sentences can host successful anaphoric linkage indicates that negative sentences are interpreted in a nonfactual mood. Furthermore, the successful anaphoric linkage in the modal subordination context illustrated in (8b) indicates that sentential negation comes with an implicit restriction with respect to which the scope is evaluated. Together with the essential nature of negation as discussed in the previous section, this suggests that sentential negation asymmetrically relates two propositions---one constitutes its restriction and the other its scope.

2.2 Sentential negation and its sub-interval property

Besides their context dependency, negative sentences have sub-interval properties that are characteristic of state-denoting sentences. Thus, in the following example, the state in which Peter didn’t run twenty miles holds throughout the interval denoted by the adverb *yesterday*:

- (12) a. Yesterday, Peter didn’t run twenty miles.
 b. |-----|<----->|-----|

YESTERDAY

This property has led some scholars to argue that negation is a special operator that converts all event descriptions to state descriptions (Bennett & Partee 1972, Dowty 1979, Verkyul 1993, de Swart & Molendijk 1999, among others). This Stativity Hypothesis has been supported by negation’s compatibility with durative adverbials as in (13a) and its incompatibility with time-span adverbials as in (14a):

- (13) a. The ship didn’t arrive for two days.
 b. *The ship arrived for two days.

- (14) a. The ship will not arrive in two days.
 (i) ^{OK}not > in two days
 (ii) *in two days > not
 b. The ship will arrive in two days.

Assuming that durative adverbials are compatible with atelic predicates, contrasts such as the one between (13a) and (13b) have been used in favor of the Stativity Hypothesis of the negative operator. Contrasts such as the one between (14a) and (14b) also support the Stativity Hypothesis assuming that time-span adverbials are only compatible with telic predicates. Thus, states derived by negation are states characterized by non-occurrence of a specific type of event.

However, the Stativity Hypothesis, plausible as it may look, has problems which have been pointed out in the literature. In what follows, I present three such problems.

2.2.1 *Sub-event properties of negated telic event descriptions*

The first problem has to do with the sub-event and no sub-event contrast between telic and atelic predicates in the scope of negation. The following examples are a case in point:

- (15) a. The package didn't arrive. (Achievement)
 b. Peter didn't run twenty miles. (Accomplishment)
- (16) a. Peter didn't run. (Activity)
 b. Peter wasn't sick. (State)

Telic predicates such as *arrive* and *run twenty miles* in (15) can have sub-event readings in the scope of negation. So, in (15b), for example, the sentence can be true when Peter ran but didn't complete the twenty-mile run. Atelic predicates such as *run* and *be sick* do not have sub-event properties. Thus, in (16), no sub-event of Peter's running holds in (16a). Likewise, no sub-state of Peter's being sick holds in (16b).

These examples are problematic for the Stativity Hypothesis because the negative operator does not seem to stativize the event descriptions in (15).

2.2.2 *Lack of present orientation in negated event descriptions*

The second problem has to do with the interpretation of negated event descriptions in present tense. If negation is a stativizer that converts all the event descriptions to state descriptions as predicted by the Stativity Hypothesis, it is predicted that negated event descriptions, when they occur in present tense, will be interpreted on a par with state descriptions. However, this prediction is not borne out, as the following examples indicate:

- (17) a. Peter doesn't smoke. (Habitual)
 b. Peter smokes. (Habitual)
- (18) a. Peter doesn't love Mary. (Present Orientation)
 b. Peter loves Mary. (Present Orientation)

In English, states and other event descriptions (activities, accomplishments and achievements) differ in the interpretation of the present tense form. With present tense morphology, only states can denote a situation that holds at the utterance time as in (18). Non-state present tense event descriptions have a habitual interpretation as in (17). What is unexpected, given the hypothesis that negation is a stativizer, is that negation fails to yield an ongoing interpretation for all event descriptions. In fact, just like their affirmative counterparts, negated present tense non-state utterances only allow a habitual interpretation.

2.2.3 *Consecutive readings of negated event descriptions in discourse*

States and perfective event descriptions are also distinguished by their role in narratives. While non-state descriptions advance narrative time, states typically fail to do so (Dowty 1986, Kamp and Reyle 1993). The two events in (19a) below are consecutive: Bill's smiling is interpreted as following (and possibly being a consequence of) Mary's looking at him. In contrast, (19b) is interpreted as Bill's smiling having begun (and possibly continuing after) the time when Mary looked at him:

- (19) a. Mary looked at Bill. He smiled.
 b. Mary looked at Bill. He was smiling. (Kamp & Ryle 1993)

A negated event description also advances narrative time, similarly to its affirmative counterpart in (19a). The second sentence in (20a) is interpreted as stating that Bill did not smile as a consequence of Mary's looking at him; that is, the expected reaction of Bill's smiling did not happen. The consecutive reading of the negated event description can be contrasted with the interpretation of a negated state. The overlapping interpretation of the negated state in (20b) is also parallel to its affirmative counterpart in (19b):

- (20) a. Mary looked at Bill. He didn't smile.
 b. Mary looked at Bill. He wasn't smiling. (Kamp & Ryle 1993)

2.3 *Section summary: what do negative sentences denote?*

The essential nature of sentential negation and the fact that negative sentences support modal subordination discussed in section 2.1 indicate that sentential negation relates two propositions p and q such that they are asymmetrically related and that the truth of p is essential to the truth of q . Thus, sentential negation must have at least the following structure:

- (21) [*Neg*: p][q]

In section 2.2, we have seen that even though negative sentences have an important property in common with state descriptions in that both have sub-interval properties, they cannot be identified. The descriptive generalization about negative sentences is that they

display sub-interval properties without affecting the aspectual property of the predicate involved.

Whatever the semantics of sentential negation we come up with, we must be able to capture the two properties summarized above and incorporate them into the semantics of sentential negation. This is what we do in the following two sections. In section 3, I provide a necessary ingredient to account for one of the properties of sentential negation identified in section 2.2, namely the fact that negative sentences that display sub-interval properties without affecting the aspectual property of the predicate involved. To do so, I develop a situation-theoretic analysis of the four Vendlerian aspectual classes of verbs building on Rothstein's (1999) mass-count distinction in the verbal domain. In particular, I argue that semantically a Larsonian VP shell is structured in such a way that the denotation of the lower VP is found in the mass domain while that of the upper VP is found in the count domain. This is based on Rothstein's (1999) analysis of the '*be* + AP' structure, where the denotation of AP is found in the mass domain and the function of *be* is to instantiate a set of mass- eventualities denoted by the AP. I show that the denotation of the negative operator is found in the mass-domain on a par with the denotation of AP. The analysis of sentential negation as a domain shifter sets the stage to account for the fact that sentential negation does not affect the aspectual property of the predicate it interacts with.

In section 4, I define the semantics of sentential negation that accounts for the context dependency discussed in section 2.1. I show that the proposed semantics also provides a principled account of why sentential negation interacts with lexical aspect the way it does.

3 The mass-count distinction in the verbal domain

3.1 Rothstein (1999)

Recently, Rothstein (1999) defended a view different from what Bach (1986) suggested regarding the mass-count distinction in the verbal domain. Unlike Bach, who suggested that the denotation of telic predicates is found in the count domain and that of atelic predicates is found in the mass domain, Rothstein argues that a distinction must be made between VPs and APs, not between telic and atelic predicates. Based on the following examples, she showed that the denotation of VPs, no matter what aspectual class they belong to (i.e., states, activity, achievement or accomplishment), is found in the count domain whereas that of APs is found in the mass domain (see Rothstein 1999 for more examples of this type):

- (22) a. I made Mary know the answer three times.
 b. I made Mary worry three times. (Rothstein 1999)

- (23) a. I made Mary angry/clever (in class) three times.
 b. I made Mary be angry/clever (in class) three times. (Rothstein 1999)

In (22), the counting adverb *three times* can modify either the complement VP or the matrix VP. In contrast, the counting adverb can only modify the matrix VP in (23a) whereas when the copula *be* is present the adverb can modify either the complement or the matrix. The generalization she drew from these types of examples is that (i) the denotation of VPs, whether they are state predicates or others, is found in the count domain; (ii) the denotation of APs is found in the mass domain, and (iii) the function of *be* is to make the denotation of APs countable. Rothstein defines the denotations of VP, AP and *be* respectively as follows:

- (24) a. $\|VP\| = \lambda x.\lambda e. VP(e) \wedge \Theta_1(e) = x$, where Θ_1 is some thematic role.
 b. $\|AP\| = \lambda x.\lambda s. AP(s) \wedge \Theta_1(s) = x$, where Θ_1 is some thematic role.
 c. $\|be\| = INST = \lambda S.\lambda e.\exists s.\in .S: e = l(s)$, where S is a set of mass-states and l is an ‘instantiation’ function from a set of mass-actualities to a set of count-actualities.

In (24), VPs denote sets of count-actualities and APs denote sets of mass-actualities. The copula *be* denotes a relation between a set of count-actualities and a set of sets of mass-actualities whose function is to instantiate a set of mass-actualities denoted by an AP. Thus, in Rothstein’s analysis, it is the contribution of the copula *be* that makes the denotation of a VP composed of the copula and an AP countable.

I adopt Rothstein’s mass-count distinction and the function of *be* as a domain shifter. In the following section, I show that her analysis has a natural extension to the domain of VPs in general.

3.2 A situation-theoretic analysis of the four Vendlerian aspectual classes

This section presents a situation-theoretic reformulation of Rothstein’s mass-count distinction in the verbal domain as summarized in section 3.1 above. The decision to do so is mainly due to the semantics of sentential negation to be developed in section 4. As shown in section 2.1, the semantics of sentential negation requires that intensionality be built into its semantics due to its essential nature and non-factuality that supports modal subordination. In section 3.2.1, I introduce a version of situation semantics developed in Kratzer (1989) and provide a reformulation of Rothstein’s analysis of the copula *be* in situation-theoretic terms. The section 3.2.2 presents a situation-theoretic analysis of the four Vendlerian aspectual classes of verbs building on Rothstein’s analysis of ‘*be* + AP’.

3.2.1 Kratzer’s situation semantics: some basics

This section presents the basics of a Kratzerian Situation Semantics (Kratzer 1989). First, throughout this paper, a situation-based ontology is assumed. Specifically, a model for interpreting natural language is a tuple $M := \langle S, D, W, <, \| \| \rangle$, where:

- (25) a. S is the set of possible situations.
 b. D is the set of possible individuals. $D \subseteq S$.

- c. W is the set of possible worlds, maximal elements with respect to \leq .
- d. $<$ is a partial ordering on S .
- e. $\| \cdot \|$ is the interpretation function.

The partial ordering on S satisfies at least the following condition: for all $s \in S$ there is a unique $s' \in S$ such that $s \leq s'$ and for all $s'' \in S$: if $s' \leq s''$, then $s'' = s'$. Notice, then, that \leq imposes a mereological summation structure to S , with each world being the supremum of a complete join semilattice and each situation being part of a world. This in its turn implies that one individual can only be part of one possible world, which requires adopting some version of the counterpart theory, as advocated by Lewis (1968), to speak about possible alternatives of an actual individual.

The type theory of Kratzer's Situation Semantics is standard, except for the fact that the domain of expressions of type e , the set of individuals, is a subset of S and the domain of expressions of type t is the power set of S ($\uparrow(S)$), the set of sets of situations. Propositions, then, are sets of situations: the set of situations in which the proposition holds.

Finally, the notion of minimal situation is relevant for our purposes:

- (26) A situation is a minimal situation in which p is true if and only if it has no proper parts in which p is true.

In other words, minimal situations are stripped-down situations that contain just enough to support propositions.

Given that the mass-count distinction in terms of a Davidsonian theory of eventualities has a natural extension to the domain of situations, we can reinterpret Rothstein's (1999) the semantics of the predicative copula *be* in situation-theoretic terms as follows:

- (27) $\|be\| = INST = \lambda S_m. \lambda s_c. \exists s_m \in S_m \wedge s_c = I(s_m)$, where S_m is a set of mass-situations.

In (27), the predicative copula *be* denotes a function (INST) that takes a set of mass-situations (s_m) as its domain and yields a set of count-situations (s_c) that instantiate the set of mass-situations. Note that since the domain of situations is partitioned into the count and mass domains, the set of count situations and that of mass situations are disjoint. Thus, count and mass situations are not ordered in terms of the part-of relation, but rather they are related in terms of the instantiation function INST.

3.2.2 Arguments for a situation-theoretic analysis of the four Vendlerian aspectual classes of verbs

This section argues for an extension of Rothstein's (1999) analysis of the '*be* + AP' construction to the domain of VP in general. To do so, let us introduce the notion of aspectual classification of verbs as presented in Smith (1997) in terms of *situation* aspect classes, which

is based on the Vendlerian classification of verbs classes. Following Rothstein (2004), *situation* aspect classes are expressed by the features [stage] and [telic] as in the following:

(28) The situation aspect classes

	[stages]	[telic]
a. State	–	–
b. Activity	+	–
c. Achievement	–	+
d. Accomplishment	+	+

The feature [stage] distinguishes activities/accomplishments and states/achievements. Activities and accomplishments are grouped together for reasons that are rather clear. They both can be said to ‘go on’ in the sense that the situation develops from one stage to another as time goes on. In other words, both accomplishments and activities are ‘dynamic’. In contrast, states and achievements cannot naturally be said to ‘go on’. States are essentially static and as such no stages can be distinguished. Similarly, achievements denote instantaneous states of affairs and as such the events described are too short to define stages. The feature [telic] singles out event descriptions with an inherent endpoint.

I argue that the aspectual properties of verbs or VPs are defined in terms of the instantiation of some type of state in the sense of Rothstein’s (1999) analysis of the predicative copula *be* + AP as the instantiation of mass-states denoted by AP. To do so, I follow Kamp and Rossdeutscher’s (1994) analysis of process verbs such as *cure* which entails that there is a state corresponding to RES(CURE)(*u*, *v*), a result-state which obtains when an individual *u* is cured of a disease *v* and presupposes a state corresponding to PRE(CURE)(*u*, *v*), a pre-cure state. Borrowing Kamp and Rossdeutscher’s state concepts RES and PRE and an intermediary state concept TRN, a transition state concept, between RES and PRE which I introduce in what follows, I argue that a VP denotes a set of count-situations that instantiate a set of mass-situations denoted by one of the state concepts mentioned above of the four Vendlerian verb classes. Reinterpreting this analysis in terms of the situation semantics adopted here requires that mass-situations be a realization of a particular combination of the aspectual features [stage] and [telic] as in the following:

- (29) a. $\|love\| = \lambda y. \lambda x. \lambda s_c. \exists s_m [(\text{PRE}(\text{BECOME}(\neg \text{LOVE})))(x, y, s_m) \wedge s_c = I(s_m)]$
 b. $\|arrive\| = \lambda x. \lambda s_c. \exists s_m [(\text{RES}(\text{ARRIVE})))(x, s_m) \wedge s_c = I(s_m)]$

State predicates such as *love* in (29a) are defined in terms of a set of count-situations s_c that instantiate a set of mass-situations s_m denoted by a pre-state concept PRE. Achievement predicates such as *arrive* in (29b) are defined in terms of a set of count-situations that instantiate a set of mass-situations denoted by a result-state concept RES.

What about activity and accomplishment predicates? Unlike state and achievement predicates, activity and accomplishment predicates are dynamic in the sense that they move events associated with the predicates from one stage to another. They only differ in that

accomplishment predicates have a natural end-point whereas activity predicates don't. In terms of features, activity and accomplishment predicates differ only in the feature [telic]. Thus, in order to characterize the feature that these predicates have in common, we need a state concept that corresponds to [+stage]. I argue that the state in question in fact exists, and I call it a transition state. The existence of this is evidence by the following example:

(30) The white paper (gradually) became red.

In (30), a state in which the paper is white constitutes a pre-state and a state in which the paper is red corresponds to a result-state. Besides these states, there is a third state that is neither a pre nor a result state, a state corresponding to a transition from the paper being white to the paper being red. I call this state a transition state and the corresponding state concept TRN.

A transition state differs from pre or result states in that a transition state is a collection of stages that contains an onset of change and a stage immediately before the coda that entails the end-point. Pre-states do not entail that an individual is in the process of change and result-states denote states resulting from a change. I propose the following scale that relates these states:

(31) $s_0 >_t s_1 >_t s_2$, where s_0 = a pre-state; s_1 = a transition state; s_2 = a result-state; $>_t$ is a proper order that temporally orders these three states.

(32) a. s_2 : RES(C)
 b. s_1 : TRN(C)
 c. s_0 : PRE(C), where C is some process concept.

In (31), $s_0 >_t s_1 >_t s_2$ indicates that these states are mutually exclusive (i.e., there is no overlapping among them). The scale that these states are associated with is ordered in terms of 'separation' a notion is adopted from Kamp and Rossdeutscher (1994). For example, a state resulting from an individual u being cured of a disease v (i.e., RES(CURE)(u, v)) is characterized in terms of a complete or maximal cure of the disease whereas a pre-state of a disease being cured does not entail that the curing process has started. The existence of a state that is in a transition from not being cured to being cured indicates that a transition state characterizes some separation of an individual from a disease. Given that we have a transition state, pre-states are characterized in terms of no separation of an individual from a disease.

Now we can define the other two types of verbs, namely activities and accomplishments as follows:

(33) a. $\|run\| = \lambda x. \lambda s_c. \exists s_m [(\text{TRN}(\text{RUN}))(x, s_m) \wedge s_c = I(s_m)]$
 b. $\|eat\| = \lambda y. \lambda x. \lambda s_c. \exists s_m [(\text{RES}(\text{DO}(\text{TRN}(\text{EAT}))))(x, y, s_m) \wedge s_c = I(s_m)]$

The activity verb *run* in (33a) is defined in terms of a set of count-situations that instantiate a set of transition states. The definition of the accomplishment verb *eat* in (33b) is complex in that it has a transition state concept built into the definition. This is due to the fact that accomplishment verbs are like activity verbs but differ from them in that they have an inherent end-point, which is realized by RES in (33b).

Although the instantiation function *INST* is defined as part of the lexical meaning of the verbs in (29) and (33), there is good reason to derive it syntactically without stipulating it as part of the lexical meaning of each verb. I argue in what follows that this function is licensed by the small 'v' and that VP, the complement of v, denotes a set of mass-situations subject to the instantiation by the locating function licensed in the specifier of v.

Evidence in favor of not introducing *INST* in (29) and (33) lexically comes from the two types of adverbials discussed by Bowers (1993; 2001), namely, manner adverbials such as *quickly* and result adverbials such as *perfectly*. Building on Bowers' insight on the distribution of these adverbials, I argue that manner adverbials are modifiers of the vP that function as predicates of count-situations whereas result adverbials are modifiers of the lower VP that function as predicates of mass-situations.

Bowers (1993; 2001) showed that there is a distributional difference between manner adverbials such as *slowly* and *quickly* and result adverbials such as *poorly* and *perfectly*. Bowers argued that manner adverbials are modifiers of a higher V and result adverbials are modifiers of a lower V. He provides the following examples to make the point:

- (34) a. Bill (*poorly/slowly) recited his lines (poorly/slowly).
 b. John (*perfectly/immediately) learned French (perfectly/immediately).
- (35) a. John immediately learned French perfectly.
 b. *John perfectly learned French immediately.

The examples in (34) show that result adverbials cannot occur pre-verbally whereas manner adverbials can be either pre- or post-verbal. The examples in (35) show that manner and result adverbials are not interchangeable.

Intuitively speaking, what a manner adverb modifies in (34) and (35) is a process or an event involved in the predicates in these examples whereas a result adverb modifies the quality of the event entailed by these examples. Thus, in (35a), for example, the process or the event of learning French was immediate whereas it is the quality of the event entailed by the sentence that was judged as perfect. This intuitive semantic difference is further evidenced by the following examples, where result adverbs are compatible with AP complements of causative *make* whereas manner adverbs are not:

- (36) Mary made her son (perfectly) polite (perfectly).

- (37) Mary made her son (*quickly) quiet (*quickly). (Rothstein 1999)

Rothstein (1999) discussed the incompatibility of a manner adverb directly modifying AP as in (37) but didn't discuss the compatibility of a result-adverb with AP in (36). Given the contrast between (36) and (37), we can infer that result adverbs are modifiers of mass-situations and that manner adverbs are modifiers of count-situations. Building on Rothstein's (1999) distinction between count- and mass-eventualities, the contrast in compatibility between manner and result adverbs in the AP causative construction illustrated in (36) and (37) indicates that result adverbs are modifiers of mass-situations whereas manner adverbs are modifiers of count-situations. Given the distributional difference between manner and result adverbs in the domain of VPs discussed above, we are in a position to generalize the distinction between count and mass-situations to the domain of VPs including not only VPs constructed from *be* and an AP but also those constructed from the four Vendlerian verb classes. To this end, I propose the following structure of vP :

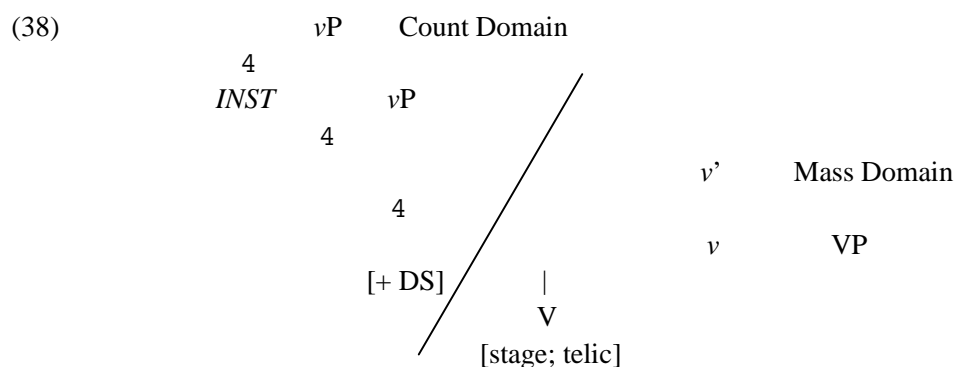

- (39)
- a. [-stage; -telic]: $\|VP\| = \lambda s_m.(\text{PRE}(\text{BECOME}(\neg P)))(x_{1..n}, s_m)$
 - b. [+stage; -telic]: $\|VP\| = \lambda s_m.(\text{TRN}(P))(x_{1..n}, s_m)$
 - c. [-stage; +telic]: $\|VP\| = \lambda s_m.(\text{RES}(P))(x_{1..n}, s_m)$
 - d. [+stage; +telic]: $\|VP\| = \lambda s_m.(\text{RES}(\text{DO}(\text{TRN}(P))))(x_{1..n}, s_m)$

In (38), VP denotes a set of mass-situations. Thus, its denotation is in the mass domain as indicated in (38). The type of mass-situation the VP denotes depends on the combination of the aspectual features [stage; telic] as illustrated in (39). In (39a), VP denotes a set of mass-situations that instantiate a pre-state concept. In (39b), VP denotes a set of mass-situations that instantiate a transition state concept. In (39c), VP denotes a set of mass-situations that instantiate a result-state concept. In (39d), VP denotes a set of mass-situations that instantiate a complex state concept constructed from transition and result state concepts.

In (38), vP denotes a set of count-situations. Thus, its denotation is in the count domain as indicated in (38). The instantiation function *INST* is licensed by the complex of $v+V$ created after V adjoins to v . I assume that v carries a feature [+DS] ('domain shifter') that licenses *INST*. The nature of *INST* is determined by the aspectual features of the V adjoined to v . When the V has features [-stage; -telic], it denotes *BE*, which makes vP a state predicate. When the V has features [+stage; -telic], it denotes *DO*, which makes vP an activity

predicate. When the V has features [-stage; +telic], it denotes *BECOME*, which makes *vP* an achievement predicate. Finally, when the V has features [+stage; +telic], it denotes *BECOME*, which makes *vP* an accomplishment predicate. Note that both achievement and accomplishment predicates are telic predicates. However, they differ in the respective internal structures. In the case of achievement predicates, *BECOME* instantiates a set of mass-situations of the result-state type whereas in the case of accomplishment predicates, *BECOME* instantiates a set of mass-situations of the result-state type that in turn is mediated by a transition state concept.

3.2.3 Sentential negation as a domain shifter

Recall that Rothstein's (1999) analysis of the copula *be* is a domain shifter that takes a set of mass-situations as its domain and a set of count-situations as its range. The function of *be* in her analysis is to present mass-states denoted by APs from a count perspective. I show in what follows that sentential negation does the opposite. That is, sentential negation is a domain shifter that takes a set of count-situations as its domain and a set of mass-situations as its range. The following examples provide evidence that this is the case:

- (40) a. John isn't being polite to his uncle.
 b. John is being not polite to his uncle.

In (40), it is in (40a) that the negative marker *not* expresses sentential negation. *Not* in (40b) can only express constituent negation. The examples indicate that in order for *not* to express sentential negation the domain that the negative operator applies to must be in the count domain. The failure of *not* to express sentential negation shows that *not* cannot operate on the denotation of AP which is mass in the present analysis. The negative operator as a domain shifter provides a natural explanation of why that is the case. Furthermore, the negative operator as a domain shifter also provides a step toward the explanation of why negative sentences have sub-interval properties without affecting the aspectual property of the predicate that negation interacts with.

4 The semantics of sentential negation

4.1 Sentential negation and 'universal' adjectives

In section 2.1, I suggested that sentential negation is relational in the sense that it asymmetrically relates two propositions such that the truth of one is essential to the truth of the other. The goal of this section is to find out what exactly is the nature of this relation is. To do so, let me introduce a particular type of lexically driven inference discussed in Kamp and Rossdeutscher (1994). The type of inference in question has to do with the inferential behavior of two types of adjectives such as *healthy* vs. *sick*, *safe* vs. *dangerous*, *dry* vs. *wet*, to name a few. Kamp and Rossdeutscher (henceforth, K&R) call the former type of

adjectives ‘universal’ and the latter type ‘existential’. The terms are based on the way these types of adjectives behave in the two sets of inferences to be discussed in what follows.

K&R point out that universal adjectives such as *healthy* and existential adjectives such as *sick* behave differently with respect to the validity of certain inferences. Consider the following set of inferences adapted from K&R:

- (41) a. A tourist comes down with typhoid.
After three weeks, the tourist is *healthy*.

∴ The tourist recovers from typhoid in these three weeks.
- b. A tourist recovers from typhoid.
After three weeks, the tourist is *sick*.

∴ The tourist comes down with typhoid in these three weeks.

The two inferences appear to be symmetric, yet the conclusion in (41a) follows from the two premises whereas the conclusion in (41b) doesn't. According to K&R, the conclusion in (41a) is a logical consequence derived from the two premises based on the semantics of the adjective *healthy*. K&R attribute the contrast in validity to the universal nature of *healthy* and the existential nature of *sick* and propose the following semantics of these adjectives:

- (42) a. $\|healthy\| = \lambda s.\lambda x.\forall w[AILMENT(w, s) \rightarrow RES(CURE)(x, w, s)]$
b. $\|sick\| = \lambda s.\lambda x.\exists w[AILMENT(w, s) \wedge PRE(CURE)(x, w, s)]$

Given the semantics of these adjectives defined in (42), let us examine how the semantics account for the contrast in validity between (41a) and (41b). The first premise in (41a) entails that the tourist has typhoid, the onset of which is deduced from the second premise, that is, the onset of the three-week period. Given the semantics of *healthy* defined in (42a), the Universal Instantiation rule applies, which removes the antecedent of the universal quantifier and we obtain the result-state. The result-state $RES(CURE(\text{the-tourist}, \text{typhoid}))$ (i.e., the state of the tourist being cured of typhoid) obtains sometime within the three-week period. Since the existence of the tourist having typhoid is instantiated at the onset of the three-week period, given the result-state being instantiated, we can infer that there is a change of state event that takes place sometime within the three-week period that is immediately preceded by the state of the tourist having typhoid and immediately followed by the result-state. The change of state in question is one from the state of the tourist having typhoid to the state of his being cured of typhoid, which takes place sometime within the three-week period. In other words, the change of state is one in which the tourist recovers from typhoid in these three weeks. This is equivalent to the conclusion stated in (41a); therefore, the inference is valid.

The account of the invalidity of (41b) can be brief. Given the existential nature of *sick* defined in (42b), it is clear that Universal Instantiation cannot apply. Consequently, we

cannot derive a relevant pre-cure state (i.e., PRE(CURE(the-tourist, typhoid))) or a change of state that corresponds to the conclusion in (41b).

Now, let us consider the following inference involving negation:

- (43) Black stains appear on the table.
 After three hours, there aren't stains on the table.

 ∴ Black stains disappear from the table in these three hours.

Interestingly, in (43), negation in the second premise patterns with *healthy* in (41a) in that negation contributes to the validity of the argument. What is crucial for the validity of the inference illustrated in (43) is that sentential negation must incorporate a change of state built into its semantics. This is the driving force to account for the logical validity illustrated in (43). In the next sub-section, I propose a semantics of sentential negation that incorporates this change of state.

4.2 A situation-theoretic analysis of the semantics of sentential negation

In the possible situation semantics adopted here, proposition denote sets of possible situations, or characteristic functions of such sets, and all predicates are evaluated with respect to possible situations. Given the essential nature of negation, in the present analysis, we treat negation as a modal operator and it is defined as follows:

- (44) a. $\|Neg\|^c = \lambda P. \lambda s_m. \forall s' [[\min(f_c(s)) = s' \wedge s' \in \|\text{PRE}(\text{BECOME}(\neg P))\|] \rightarrow \exists s'' [s' \leq s'' \wedge s'' \in \|\text{RES}(\text{BECOME}(\neg P))\| \wedge s = g(s \in \|P\|)]]$
 b. The grinding function is that function $g: C \rightarrow M$ such that for every $c \in C$:
 $g(c) = \cup \{x \in M: xKc\}$, where K is the relation 'material part of'.

The definition in (44a) incorporates a change of state from P to not P, where 'P' constitutes a set of pre-states and 'not P' a set of result-states. The nature of the change is from the potential realization of the property P to the potential being not realized. The nature of P is contingent on the aspectual property of P, which I come back to shortly. Thus, (44a) denotes the relation between sets of properties P and situations s such that every minimal situation s' that is accessible from s and instantiates a pre-state concept (PRE(BECOME((¬P))) is extendable to a situation s'' of which s' is a part and instantiates the result-state concept (RES(BECOME (¬P))). The pre-state here corresponds to a state of becoming not P, which entails that P holds. The result-state corresponds to a state obtained after becoming not P. This amounts to meaning that every pre-state is extendable to its corresponding result-state, that is, 'no degree of P-ness'.

P in (44a) is a predicate variable that represents a VP denotation. The denotation of VP is a set of count-situations represented as s in (44a). 'g' denotes a grinding function, a function

from count-situations to mass-situations. The result of g applying to count-situations is the sum of all count-situations s_c that instantiate P . The grinding function as defined in (44b) is a homomorphism, preserving crucial ordering relations, so that if a is a part of the plural individual $a + b$, then the stuff making up a is a part of the stuff making up $a + b$. Thus, what *Neg* does is to present from a mass perspective the complement set of the set of count-situations denoted by the VP. The semantics of sentential negation thus defined functions as a the domain shifter discussed in section 3.2.3. It is a domain shifter that takes a set of count-situations as its domain and a set of mass-situations as its range.

' f ' in (44a) denotes an accessibility relation in the sense of Kratzer's conversational background (1991). It is a function from evaluation situations s to possible situations s' that are accessible from s . 'min' is an operator that picks up minimal situations from the result of f applying to s . The nature of the accessibility relation denoted by f is determined by the lexical property of the negative operator in interaction with properties of the utterance context c . The modality associated with the negative operator is circumstantial. The circumstantial accessibility relation is *realistic* in the sense of Kratzer (1991) in that it assigns to every situation a set of facts that the speaker knows up to the point of utterance. Thus, given the semantics of negation defined in (44a), if adding the proposition expressed by $\text{PRE}(\text{BECOME}(\neg P))$ to the set of accessible situations conforms the facts of the world provided by the accessible situations, that is, the addition does not contradict with the context assumed up to the point of utterance, then the consequent expressed by $\text{RES}(\text{BECOME}(\neg P))$ also holds; otherwise, the antecedent denotes an empty set and the whole proposition is rendered to be true whether or not the consequent is true. However, the consequent cannot be true if the antecedent is false. This is because the consequent denotes a result-state and a result-state presupposes a pre-state from which the result-state follows. Thus, the consequent cannot be rendered true; otherwise, it would be a presupposition failure. Therefore, in order for the sentence to be true in this context, both the antecedent and the consequent have to be false. This means that given the semantics of negation defined in (44a), the result-state can only be inferred if the corresponding pre-state is instantiated in the evaluation situation. This is what happens in the valid inference we have considered in (43) above.

In (43), the first premise entails that there are black stains on the table, and from the temporal specification in the second premise, the existence of the black stains takes effect at the onset of the three-hour period; hence, the existence of black stains on the table is instantiated in the evaluation situation. This information becomes part of what the speaker knows about the world. Given that the set of black stains is a subset of the set of stains, the effect of adding the pre-state in the antecedent clause, namely, the set of situations in which there are stains on the table, is to instantiate the consequence by instantiating the proposition in the antecedent clause. From this, we can infer that there is a state resulting from black stains becoming non-existent. The conclusion follows from the fact that there is a change of state that is inferred from the state where there are black stains on the table followed by a state resulting from the disappearance of black stains on the table, which takes place sometime within the three-hour period.

The above discussion indicates that, generally, when we utter a negative statement, we don't know whether or not the pre-state holds in the evaluation situation. On the pragmatic side, this means that in uttering a negative statement, we consider whether the pre-state holds or not. If we assume it does, we hypothetically add it to the set of accessible situations and evaluate the consequence with respect to the modified set of accessible situations. If we assume it doesn't, adding it to the set of accessible situations leads to a contradiction; consequently, the antecedent is rendered false and the whole statement is rendered to be true only if the consequent is false (otherwise, this would result in a presupposition failure as mentioned above).

Now that quantification is over possible situations accessible from the set of evaluation situations, the non-existential commitment characteristic of the essential quantification follows naturally without stipulations.

5 Sentential negation and its interaction with lexical aspect

5.1 *Sentential negation and scales*

The semantics of sentential negation proposed in section 4.2 provides a principled account of the way negation interacts with lexical aspect. In section 3.2.2, I proposed a situation-theoretic analysis of the four Vendlerian aspectual classes of verbs building on Rothstein's (1999) mass-count distinction in the verbal domain.

Given the semantics of sentential negation defined in (44a), the negative operator operates on the scale proposed in section 3.2.2 repeated here as (45) and (46):

(45) $s_0 >_t s_1 >_t s_2$, where s_0 = a pre-state; s_1 = a transition state; s_2 = a result-state; $>_t$ is a proper order that temporally orders these three states.

(46) a. s_2 : RES(C)
 b. s_1 : TRN(C)
 c. s_0 : PRE(C), where C is some process concept.

In (45), $s_0 >_t s_1 >_t s_2$ indicates that these states are mutually exclusive (i.e., there is no overlapping among them). As in (46), the scale that these states are associated with is ordered in terms of 'separation' a notion is adopted from Kamp and Rossdeutscher (1994).

The semantics of sentential negation defined in (44a) incorporates a change of state from a potential realization of the property P to the potential being not realized. Given the semantics of the four Vendlerian aspectual classes of verbs, this 'potential realization of the property P' is translated as 'potential instantiation of a set of mass-situations denoted by a νP '. One of the properties of negative sentences, namely their sub-interval property that does not affect the aspectual property of the predicate, is a consequence of the semantics of sentential negation that incorporates a change of state together with the semantics of the four

Vendlerian aspectual classes of verbs proposed above. In the next sub-section, I will illustrate how the proposed system works.

5.2 *Solutions to the problems of the Stativity Hypothesis*

5.2.1 *Sub-event properties of negated telic event descriptions*

The *sub-event* problem for the Stativity Hypothesis has a natural solution within the system developed here. Given the scale proposed in (45) and (46) above, the change of state from a potential instantiation of a set of mass-situations denoted by achievement or accomplishment VP to the potential being not realized predicts that the event denoted by these predicates is either in a transition state or a pre-state. Thus, in the following examples, the package is either on the way to being delivered (a transition state of the package being delivered) or in a state prior to the initial stage of delivery (a pre-state of the package being delivered) in (47a). The example that involves an accomplishment predicate in (47b) has a similar explanation:

- (47) a. The package didn't arrive.
b. Peter didn't run twenty miles.

The fact that negated activity event descriptions and state descriptions do not have sub-event properties is also predicted by the proposed analysis:

- (48) a. Peter didn't run.
b. Mary doesn't love Peter.

In (48a), the potential instantiation of the property of running was not realized. Given the scale in (46), the negation of a transition state entails a pre-state of running. No sub-event holds for activity predicates. In (48b), the potential instantiation of the property of loving is not realized. No sub-event holds in this case either.

5.2.2 *Lack of present orientation in negated event descriptions*

The change of state built into the semantics of sentential negation also accounts for the lack of present orientation in negated event descriptions:

- (49) a. Peter doesn't smoke.
b. Mary doesn't love Peter.

In (49a), a potential instantiation of the property P, namely Peter's habit of smoking is not realized, which gives the habitual reading (49a). (49b) is as illustrated in section 5.2.1. The present orientation follows without stipulations.

5.2.3 *Consecutive readings of negated event descriptions in discourse*

The contrast in the discourse interpretation between negated event and state descriptions is interesting in that the account involves the contribution of the accessibility function defined as part of the semantics of sentential negation proposed in (44a). Essentially, the accessibility function is a *conversational background* in the sense of Kratzer (1991). It functions as Stalnaker's notion of a *common ground*, a set of possible worlds believed to hold by the discourse participant. The contrast between negated event and state descriptions in the following Kamp and Ryle (1993) examples is explained in the present analysis in terms of the interaction of the accessibility function and the change of state built into the semantics of sentential negation:

- (50) a. Mary looked at Bill. He didn't smile.
 b. Mary looked at Bill. He wasn't smiling.

In (50), the first sentence enters into the discourse participants' common ground. This means that a situation in which Mary looked at Bill becomes part of the accessibility function. Then the second sentence in (50) is evaluated with respect to this modified accessibility function. In the case of (50a), the potential instantiation of Bill's smiling at Mary is interpreted as a potential instantiation of Bill's smiling at Mary as a reaction to Mary's looking at Bill being not realized. This gives us the expected consecutive reading. In the case of (50b), the potential instantiation of Bill's smiling in progress is interpreted as the potential instantiation of Bill's smiling in progress at the time when Mary looked at Bill and the potential was not realized at the time. This gives us the expected overlapping reading associated with this example.

6 Conclusion

In this paper, I have shown that sentential negation is inherently modal: it relates two propositions p and q where p is asymmetrically related to q , which is more complex in structure than is assumed for the standard analysis of sentential negation as a one-place propositional operator. This accounts for the non-existential commitment or contextual vagueness associated with negative sentences in general.

Rothstein's (1999) analysis of *be* + AP is extended to VPs that belong to the four Vendlerian aspectual classes. I argued that VPs denote sets of count-situations that instantiate a set of mass-situations denoted by the four Vendlerian aspectual classes of verbs. This has been shown to provide a natural explanation of why sentential negation interacts with lexical aspect the way it does.

Sentential negation is a domain shifter that takes count-situations as its domain and mass-situations as its range. This together with the semantics of sentential negation accounts for its sub-interval property without affecting the aspectual property of the predicate that negation interacts with.

Acknowledgments

I'd like to thank the 23rd NWLC participants for discussions and valuable comments.

References

- Bach, E. 1986b. "The Algebra of Events", *Linguistics and Philosophy* 9: 5 – 16.
- Bennett, M. and B. Partee 1972. "Toward the logic of tense and aspect in English", System Development Corporation, Santa Monica, Calif. Reprinted in Partee, B. *Compositionality in Formal Semantics*. 2004. Oxford: Blackwell.
- Bowers, J. 1993. "The Syntax of Predication", *Linguistic Inquiry* 24.4: 591-656.
- Bowers, J. 2001. "Predication", In M. Baltin and C. Collins (eds.) *The Handbook of Contemporary Syntactic Theory*, Blackwell Publishing.
- Dayal, V. 1998. "Any as Inherently Modal", *Linguistics and Philosophy* 21: 433-476.
- de Swart, H. and A. Molendijk. 1999. "Negation and the temporal structure of narrative discourse", *Journal of Semantics* 16: 1-43.
- Donnellan, K. 1966. "Reference and Definite Descriptions." *Philosophical Review* 75: 281-304.
- Dowty, D. 1979. *Word Meaning and Montague Grammar*, Reidel, Dordrecht.
- Dowty, D. 1986. "The Effects of Aspectual Class on the Temporal Structure of Discourse: Semantics or Pragmatics?", *Linguistics and philosophy* 9: 37-61.
- Givon, T. 1978. "Negation in Language: Pragmatics, Function, Ontology", In Cole (ed.), *Syntax and Semantics 9: Pragmatics*. New York, Academic Press.
- Horn, L. 1989. *A Natural History of Negation*, University of Chicago Press.
- Kamp, H and A. Rossdeutscher 1994. "DRS-Construction and Lexically Driven Inference", *Theoretical Linguistics* 20: 165-235.
- Kamp, H. and U. Reyle. 1993. *From Discourse to Logic: Introduction to Modeltheoretic Semantics of Natural Language, Formal Logic and Discourse Representation Theory*. Studies in Linguistics and Philosophy, Vol. 42. Dordrecht: Kluwer Academic Publishers.
- Kratzer, A. 1989. "An Investigation of the Lumps of Thought." *Linguistics and Philosophy* 12: 607-653.
- Kratzer, A. 1991. "Relative Modality," in A. von Stechow and D. Wunderlich (eds.), *Semantics: An International Handbook of Contemporary Research*, Walter de Gruyter, Berlin.
- Lewis, David. 1968. "Counterpart Theory and Quantified Modal Logic." *Journal of Philosophy* 65. 113-126.
- Roberts, C. 1989. "Modal Subordination and Pronominal Anaphora in Discourse", *Linguistics and Philosophy* 12: 683 – 721.
- Rothstein, S. 1999. "Fine-grained Structure in the Eventuality Domain: the Semantics of Predicative Adjective Phrases and *Be*", *Natural Language Semantics* 7: 37 – 420.
- Rothstein, S. 2004. *Structuring Events: A Study in the Semantics of Lexical Aspect*. Blackwell Publishing.
- Smith, C. 1997. *The Parameter of Aspect*. Dordrecht. The Netherlands: Kluwer.
- Verkuyl, H. 1993. *A Theory of Aspectuality*. Cambridge: Cambridge University Press.

Syntactic types of Russian expressive suffixes

Olga Steriopolo

University of British Columbia
olgasteriopolo@hotmail.com

ABSTRACT

In this paper, I investigate Russian expressive suffixes. I show that they have different formal properties: some suffixes can change categorial properties of the base, while others cannot. I propose that this difference in formal properties is syntactically conditioned: some expressive suffixes are syntactic heads, while others are syntactic modifiers.

Keywords: morphosyntax; morphology; Russian; expressive; suffixes.

1 Introduction

Russian expressive suffixes differ in their formal properties. Some expressive suffixes change categorial properties of the base form, while others never do. For example, in (1), the expressive suffix *-in* changes grammatical gender and inflectional class of the noun *bolót-o* 'swamp'. In (2), a different expressive suffix, *-c*, does not change gender or inflectional class of this noun.

- | | | |
|-----|------------------------------------------------------------|-------------------------------------------------------------------------------------------|
| (1) | a. bolót-o
<i>swamp-N.SG (NEUT; CLASS I)</i>
'swamp' | b. bolót'- in -a
<i>swamp-EXPR-N.SG (FEM; CLASS II)</i>
'swamp (expressive)' |
| (2) | a. bolót-o
<i>swamp-N.SG (NEUT; CLASS I)</i>
'swamp' | b. bolót- c -e
<i>swamp-EXPR-N.SG (NEUT; CLASS I)</i>
'swamp (expressive)' |

With respect to the data above, the following questions arise: (i) What are the formal morphosyntactic properties of Russian expressive suffixes? and (ii) What accounts for the differences in their formal properties?

As is shown in Steriopolo (2008), expressive suffixes in Russian belong to different semantic types: Type I suffixes express the speaker's attitude towards the referent (attitude suffixes); while Type II suffixes refer to the size of the referent (size suffixes). In this paper, I argue that Russian expressive suffixes also differ syntactically. Attitude suffixes are syntactic heads (3a), while size suffixes are syntactic modifiers (3b).

(3) a. HEADS



b. MODIFIERS



The traditionally accepted distinction between heads and modifiers lies in the projection of category features. Heads project (i.e., they determine a category and grammatical features of the output), while modifiers do not project (i.e., they do not determine a category and grammatical features of the output) (see Bierwisch 2003, Schütze 1995, Bachrach & Wagner 2007 for a discussion on heads vs. modifiers). Based on this distinction, the following three diagnostics will be used to determine syntactic types of Russian expressive suffixes (4).

(4) *Diagnostics* (cf. Bachrach & Wagner 2007, p. 4)

Diagnostic I: Do expressive suffixes change syntactic category?

Diagnostic II: Do expressive suffixes change grammatical gender?

Diagnostic III: Do expressive suffixes change inflectional class?

Expressive suffixes are classified as syntactic heads if the answers to the questions in (4) are affirmative. In contrast, expressive suffixes are classified as modifiers if the answers to the questions are negative (Table 1).

Table 1

Diagnostics for syntactic heads vs. syntactic modifiers

Diagnosics	Syntactic heads	Syntactic modifiers
Do expressive suffixes change syntactic category?	✓	*
Do expressive suffixes change grammatical gender?	✓	*
Do expressive suffixes change inflectional class?	✓	*

I use these diagnostics to argue that attitude suffixes are heads, while size suffixes are modifiers. In §2, I analyze a change in syntactic category; in §3, I analyze a change in grammatical gender; in §4, I analyze a change in inflectional class; and in §5, I present the conclusions.

2 Change in category

In this section, I apply Diagnostic I (change in syntactic category). I show that attitude suffixes produce a change in syntactic category and behave like syntactic heads. Size suffixes do not produce a change in syntactic category and behave like syntactic modifiers.

I provide evidence that attitude suffixes merge with any input category (a/v/n) and always form a noun, no matter what the input category is. In contrast, size suffixes only merge with nouns that remain nouns. In other words, attitude suffixes act as nominalizers (5a), while size suffixes act as noun modifiers (5b).

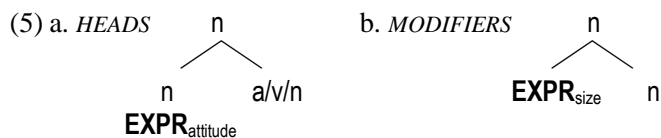

In §2.1, I analyze attitude suffixes; in §2.2, I analyze size suffixes; and in §2.3, I present the conclusions.

2.1 Attitude suffixes

The data in (6)–(8) illustrate that attitude suffixes can turn adjectives into nouns. For example, in (6), the word *žád-n-ij* ‘stingy’ is an adjective because it is formed with a productive adjectival suffix *-n*. When the attitude suffix *-úg* is attached, the adjective turns into a noun *žad-n’-úg-a* ‘stingy animate (vulgar)’. In (7), the adjective *gr’áz-n-ij* ‘dirty’ is formed with the same adjectival suffix *-n*. When the attitude suffix *-úx* is added, this adjective also becomes a noun: *gr’áz-n-úx-a* ‘dirty animate’.

- | | |
|-----------------------------------------------------------------|-----------------------------------------------------------------------------------------------|
| (6) a. <i>žád-n-ij</i>
<i>stingy-ADJ-MASC.SG</i>
‘stingy’ | b. <i>žad-n’-úg-a</i>
<i>stingy-ADJ-EXPR-N.SG (MASC/FEM)</i>
‘stingy animate (vulgar)’ |
| (7) a. <i>gr’áz-n-ij</i>
<i>dirty-ADJ-MASC.SG</i>
‘dirty’ | b. <i>gr’az-n-úx-a</i>
<i>dirty-ADJ-EXPR-N.SG (MASC/FEM)</i>
‘dirty animate (vulgar)’ |
| (8) a. <i>rod-n-ój</i>
<i>kin-ADJ-MASC.SG</i>
‘dear’ | b. <i>rod-n-úl’-a</i>
<i>kin-ADJ-EXPR-N.SG (MASC/FEM)</i>
‘dear animate (affectionate)’ |

The data in (9)–(11) show that attitude suffixes can also turn verbs into nouns. For example, in (9), the word *pr’i-l’ip-á-t’* ‘to cling’ is a verb formed with a productive verbal prefix *pri-*. When the attitude suffix *-ál* is attached, the verb becomes a noun *pr’i-l’ip-ál-a* ‘clinging animate (vulgar)’. In (10), the word *ras-t’er’-á-t’* ‘to lose’ is also a verb formed with a verbal prefix *ras-*. When the attitude suffix *-áš* is added, the verb turns into a noun *ras-t’er’-áš-a* ‘animate that loses things (affectionate)’.

- | | |
|-----------------------------------------------------------------------------|---------------------------------------------------------------------------------------------------------------------|
| (9) a. <i>pr’i-l’ip-á-t’</i>
<i>VERB.PREF-cling-TH-INF</i>
‘to cling’ | b. <i>pr’i-l’ip-ál-a</i>
<i>VERB.PREF-cling-EXPR-N.SG (MASC/FEM)</i>
‘clinging animate (vulgar)’ |
| (10) a. <i>ras-t’er’-á-t’</i>
<i>VERB.PREF-lose-TH-INF</i>
‘to lose’ | b. <i>ras-t’er’-áš-a</i>
<i>VERB.PREF-lose-EXPR-N.SG (MASC/FEM)</i>
‘animate who loses things (affectionate)’ |

- (11) a. **za-v'ir-á-t'**
VERB.PREF-lie-TH-INF
 'to lie'
- b. **za-v'ir-úx-a**
VERB.PREF-lie-EXPR-N.SG (MASC/FEM)
 'lying animate (affectionate)'

The data in (12)–(13) illustrate that attitude suffixes can also combine with nouns. Nouns that are used with attitude suffixes do not change their syntactic category. For example, in (12a), the word *čud-ák* 'an eccentric' is a noun formed with a productive nominal suffix *-ak*. In (12b), the vulgar suffix *-in* is attached, which does not change the syntactic category. The word *čud-ač'-ín-a* 'an eccentric (vulgar)' is still a noun.

- (12) a. **čud-ák**
wonder-NOM.N.SG (MASC)
 'an eccentric'
- b. **čud-ač'-ín-a**
wonder-NOM-EXPR-N.SG (MASC/FEM)
 'an eccentric (vulgar)'
- (13) a. **kras-ot-á**
pretty-NOM-N.SG (FEM)
 'beauty/prettiness'
- b. **kras-ot-úl'-a**
pretty-NOM-EXPR-N.SG (MASC/FEM)
 'pretty animate (affectionate)'

To summarize, attitude suffixes turn adjectives and verbs into nouns. Thus, they can change syntactic category, which, according to Diagnostic I, is a property of syntactic heads. Attitude suffixes always form nouns, regardless of the input category (14).

- (14) *HEAD* *n*
- / \
- n* *a/v/n*
- EXPR_{attitude}**

Table 2
 Attitude suffixes (change in a category)

EXPR _{attitude}	Input	Output
<i>-án', -áš, -ón, -úl', -ún', -úr, -ús', -úš,</i>	adjective	noun
<i>-ág, -ák, -ál, -án, -ár, -áx, -íl, -in, -ób,</i>	verb	noun
<i>-ot, -óx, -úg, -úk, -úx</i>	noun	noun

2.2 Size suffixes

In contrast to attitude suffixes, size suffixes do not change syntactic category. The data in (15)–(16) illustrate this behaviour. Neither adjectives nor verbs can turn into nouns when merging with a size suffix. For example, in (15) the adjective *žad-n-ij* 'stingy' does not become a noun when size suffixes are added. Instead, all the data used with size suffixes are ungrammatical.

- (15) a. **žad-n-ij**
stingy-ADJ-MASC.SG
 'stingy'
- b. ***žad-n-ok**
stingy-ADJ-EXPR.N.SG
 'stingy animate (diminutive)'

- | | |
|---------------------------------------------------------------------------------------|---------------------------------------------------------------------------------------------|
| c. * žad-n'-ec
<i>stingy-ADJ-EXPR.N.SG</i>
'stingy animate (diminutive)' | d. * žad-n'-išč'-e
<i>stingy-ADJ-EXPR-N.SG</i>
'stingy animate (augmentative)' |
| (16) a. gr'áz-n-ij
<i>dirty-ADJ-MASC.SG</i>
'dirty' | b. * gr'az-n-ok
<i>dirty-ADJ-EXPR.N.SG</i>
'dirty animate (diminutive)' |
| c. * gr'az-n'-ec
<i>dirty-ADJ-EXPR.N.SG</i>
'dirty animate (diminutive)' | d. * gr'az-n'-išč'-e
<i>dirty-ADJ-EXPR-N.SG</i>
'dirty animate (augmentative)' |

In (17), the verb *pr'i-l'ip-á-t* 'to cling' cannot turn into a noun when size suffixes are added. Here, like in the examples above, all the data used with size suffixes are ungrammatical.

- | | |
|--------------------------------------------------------------------------------------------------|--------------------------------------------------------------------------------------------------------|
| (17) a. pr'i-l'ip-á-t
<i>VERB.PREF-cling-TH-INF</i>
'to cling' | b. * pr'i-l'ip-ok
<i>VERB.PREF-cling-EXPR.N.SG</i>
'clinging animate (diminutive)' |
| c. * pr'i-l'ip'-ec
<i>VERB.PREF-cling-EXPR.N.SG</i>
'clinging animate (diminutive)' | d. * pr'i-l'ip'-išč'-e
<i>VERB.PREF-cling-EXPR.N.SG</i>
'clinging animate (augmentative)' |

I have shown above that size suffixes cannot turn adjectives and verbs into nouns. In addition, they cannot combine with adjectives and verbs to preserve a category. The data below show that size suffixes cannot combine with adjectives to mean 'a little bit' or 'a lot'. For example, in (18b), the diminutive suffix *-ok* is added to the adjective 'stingy'. The resulting word **žad-n-ok* does not mean 'a little bit stingy', but instead it is ungrammatical. The same holds for (18c) and (18d), where the diminutive *-ec* and the augmentative *-išč'* are ungrammatical.

- | | |
|--------------------------------------------------------------------------------------------|-------------------------------------------------------------------------------------------|
| (18) a. žád-n-ij
<i>stingy-ADJ-MASC.SG</i>
'stingy' | b. * žad-n-ok
<i>stingy-ADJ-EXPR.N.SG</i>
'a little bit stingy (diminutive)' |
| c. * žad-n'-ec
<i>stingy-ADJ-EXPR.N.SG</i>
'a little bit stingy (diminutive)' | d. * žad-n'-išč'-e
<i>stingy-ADJ-EXPR-N.SG</i>
'a lot stingy (augmentative)' |

In (19), size suffixes are added to the verb 'to cling'. The resulting words do not mean 'to cling a little bit' or 'to cling a lot', but instead they are ungrammatical.

- | | |
|-----------------------------------------------------------------------------|---------------------------------------------------------------------------------------------------------|
| (19) a. pr'i-l'ip-á-t
<i>VERB.PREF-cling-TH-INF</i>
'to cling' | b. * pr'i-l'ip-ok/ek
<i>VERB.PREF-cling-EXPR.N.SG</i>
'to cling a little bit (diminutive)' |
|-----------------------------------------------------------------------------|---------------------------------------------------------------------------------------------------------|

- c. ***pr'i-l'ip'**-ec
VERB.PREF-cling-EXPR.N.SG
 'to cling a little bit (diminutive)'
- d. ***pr'i-l'ip'**-išč'-e
VERB.PREF-cling-EXPR.N.SG
 'to cling a lot (augmentative)'

The data above illustrate that not only are size suffixes unable to turn adjectives and verbs into nouns, but they are also unable to combine with these categories to express the meaning 'a little bit' or 'a lot'. Although size suffixes do not combine with adjectives or verbs, they are productively used with nouns expressing the meaning 'little' or 'big'. For example, in (20), the size suffix *-ok* attaches to the noun *čud-ák* 'an eccentric'. The resulting word is a noun with the diminutive meaning *čud-ač'-ók* 'a little eccentric'. In (21), the size suffix *-išč'* is added to the noun *kras-ot-á* 'beauty'. The resulting word is a noun with the augmentative meaning *kras-ot-išč'-a* 'big beauty'.

- (20) a. **čud-ák**
wonder-NOM.N.SG (MASC)
 'an eccentric'
- b. **čud-ač'-ók**
wonder-NOM-EXPR.N.SG (MASC)
 'a little eccentric'
- (21) a. **kras-ot-á**
pretty-NOM-N.SG (FEM)
 'beauty/prettiness'
- b. **kras-ot'-išč'-a**
pretty-NOM-EXPR-N.SG (FEM)
 'big beauty'
- (22) a. **sos-ún**
suck-NOM.N.SG (MASC)
 'suckling'
- b. **sos-un'-éc**
suck-NOM-EXPR.N.SG (MASC)
 'little suckling'

To summarize, size suffixes can only combine with nouns with no change in syntactic category: a noun always remains a noun. Based on Diagnostic I (change in syntactic category), size suffixes behave like syntactic modifiers (namely as noun modifiers), since modifiers do not change syntactic category (23).

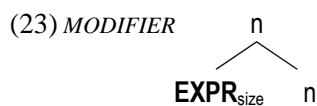

Table 3
 Size suffixes (No change in category)

EXPR _{size}	Input	Output
-k/-ek/-ok/-ik; -c/-ec/-ic; -išč'	adjective	*noun/*adjective
	verb	*noun/*verb
	noun	noun

At this point, however, the evidence is not fully conclusive, because size suffixes could be noun heads that can only combine with nouns to create nouns. In §3 and §4, I provide more evidence from Russian grammatical gender and inflectional class that shows that size suffixes are noun modifiers.

2.3 Conclusion

I have shown above that attitude suffixes can turn adjectives and verbs into nouns. They can also combine with nouns without changing syntactic category. In other words, no matter what the input category is, the resulting category is always a noun.

Size suffixes demonstrate a different behaviour. They cannot combine with adjectives and verbs, but can only combine with nouns. When used with nouns, they never change syntactic category: nouns always remain nouns (Table 4).

Table 4

Comparison of attitude and size suffixes

	Input	Output
EXPR _{attitude}	adjective	noun
	verb	noun
	noun	noun
EXPR _{size}	adjective	*noun/*adjective
	verb	*noun/*verb
	noun	noun

To conclude, attitude suffixes and size suffixes have different formal properties with respect to a change in syntactic category. Attitude suffixes can change syntactic category of the base, while size suffixes cannot (Table 5).

Table 5

Change in category

	Change in category
EXPR _{attitude}	✓
EXPR _{size}	*

Based on Diagnostic I, since attitude suffixes can change syntactic category, they behave like syntactic heads (24a). Size suffixes cannot change syntactic category, therefore, they behave like syntactic modifiers (24b).

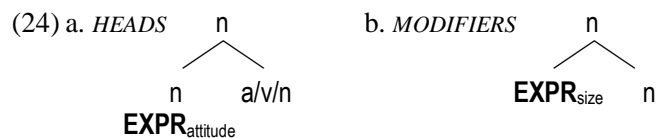

3 Change in grammatical gender

In this section, I apply Diagnostic II (change in grammatical gender). I show that attitude suffixes can change grammatical gender and thus, they behave like syntactic heads (25a).

Size suffixes, on the other hand, cannot change grammatical gender and thus, they behave like syntactic modifiers (25b).

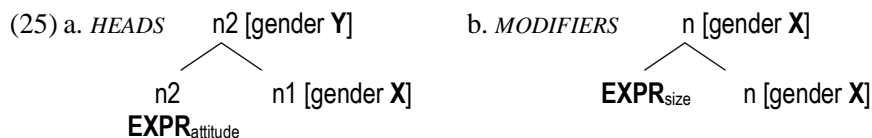

In §3.1, I analyze attitude suffixes; in §3.2, I analyze size suffixes; and in §3.3, I present the conclusions.

3.1 Attitude suffixes

Here I present evidence that attitude suffixes can change grammatical gender. Russian grammatical gender is dependent on animacy and natural gender, which are part of the semantic information of the $\sqrt{\text{Root}}$ (in the sense of Marantz 1997; notation from Pesetsky 1995). To show how attitude suffixes change gender, we first need to understand how grammatical gender is assigned. For this reason, I first look at gender assignment; after that, I analyze a change in gender. In §3.1.1, I deal with animate nouns; in §3.1.2, I deal with inanimate nouns; and in §3.1.3, I summarize the findings.

3.1.1 Animate nouns

Russian animate nouns denote living beings, such as humans, animals, and insects (Corbett 1980). Animate nouns are sex-differentiable or non-sex-differentiable (Corbett 1982, 1991). Sex-differentiable nouns are those that denote natural gender (male or female) as part of their semantics. Non-sex-differentiable nouns do not denote natural gender (26).

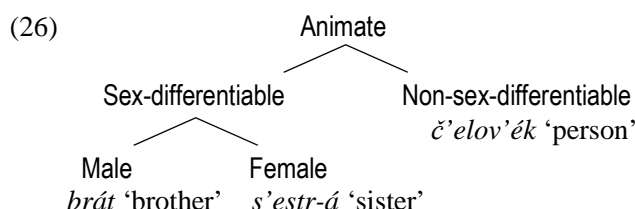

For example, the nouns *brát* 'brother' and *s'estr-á* 'sister' are animate and sex-differentiable. They are animate because they denote living beings. They are sex-differentiable because *brát* 'brother' can only denote a male being, while *s'estr-á* 'sister' can only denote a female being. In contrast, the noun *č'elov'ék* 'person' is non-sex-differentiable because it can denote persons of either sex.

In Russian sex-differentiable nouns, natural gender always takes precedence over grammatical gender (Corbett 1982, 1991). Thus, a noun that has the natural gender 'male' is always masculine. A noun that has the natural gender 'female' is always feminine (27)–(28).

- (27) a. *xoróš-ij brát*
good-MASC.SG brother.N.SG (MASC)
 ‘good brother’
- b. **xoróš-aja brát*
good-FEM.SG brother.N.SG (FEM)
 ‘good brother’
- (28) a. *xoróš-aja s’estr-á*
good-FEM.SG sister.N.SG (FEM)
 ‘good sister’
- b. **xoróš-ij s’estr-á*
good-MASC.SG sister.N.SG (MASC)
 ‘good sister’

As Russian non-sex-differentiable nouns do not have natural gender, there is no dependency of grammatical gender on natural gender. Like sex-differentiable nouns, non-sex-differentiable ones are either masculine or feminine; but unlike sex-differentiable nouns, non-sex-differentiable nouns are assigned grammatical gender arbitrarily. For example, compare *č’elov’ék* ‘person’ and *p’ersón-a* ‘person’. Both nouns are non-sex-differentiable because they can denote male and female persons, but *č’elov’ék* ‘person’ is masculine, while *p’ersón-a* ‘person’ is feminine (29)–(30).

- (29) a. *bol’š-ój č’elov’ék*
big-MASC.SG person.N.SG (MASC)
 ‘big person’
- b. **bol’š-ája č’elov’ék*
big-FEM.SG person.N.SG (FEM)
 ‘big person’
- (30) a. *bol’š-ája p’ersón-a*
big-FEM.SG person.N.SG (FEM)
 ‘big person’
- b. **bol’š-ój p’ersón-a*
big-MASC.SG person.N.SG (MASC)
 ‘big person’

Thus, sex-differentiable nouns can be masculine or feminine depending on whether the natural gender is male or female, respectively. Non-sex-differentiable nouns can also be masculine or feminine, but instead of being determined by natural gender, their grammatical genders are assigned arbitrarily (31).

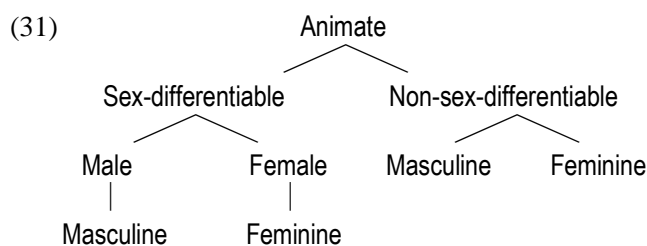

In the framework of Distributed Morphology, animacy and natural gender are analyzed as part of the semantic information of the $\sqrt{\text{Root}}$ (Müller 2005). For example, the semantics of the $\sqrt{\text{Root}}$ *s’estr-* ‘sister’ indicate that it is animate (i.e., it can only denote a living being) and sex-differentiable (i.e., it can only denote a female). When the $\sqrt{\text{Root}}$ *s’estr-* is nominalized by combining with a functional head *n*, the grammatical gender of the resulting noun depends on the natural gender ‘female’ which is encoded as part of the semantics of the $\sqrt{\text{Root}}$. As the natural gender ‘female’ always determines feminine grammatical gender, the resulting word *s’estr-á* ‘sister’ is a feminine noun (32).

Type I: Animate sex-differentiable nouns whose grammatical gender is determined by their natural gender (37a)

Type II: Animate non-sex-differentiable nouns whose grammatical gender is assigned randomly (37b)

Type III: Animate common gender nouns that are unspecified for grammatical gender (37c)

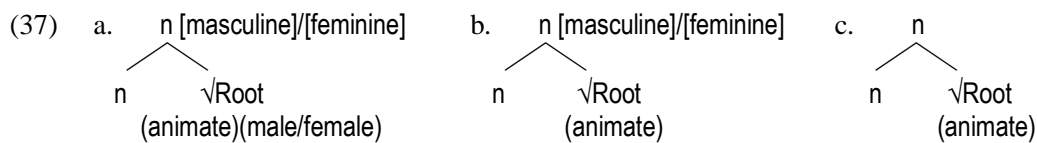

Now that gender assignment in Russian has been discussed, we can apply Diagnostic II to see if there is any change in grammatical gender when attitude suffixes are added. Here I show that attitude suffixes indeed produce a change in grammatical gender. This change involves Type II nouns (animate, non-sex-differentiable).

In (38a), the noun *zv'er'* 'animal' is animate because it denotes a living being. It is non-sex-differentiable (Type II), because it does not denote natural gender as part of its semantics (*zv'er'* 'animal' denotes both male and female animals). The grammatical gender assigned to this noun is masculine. In (38b), the attitude suffix *-úg* attaches, which changes the grammatical gender of the base. The resulting word *zv'er'-úg-a* 'animal (vulgar)' is now a common gender noun (MASC/FEM).

- (38) a. *zv'er'*
animal.N.SG (MASC)
'animal'
- b. *zv'er'-úg-a*
animal-EXPR-N.SG (MASC/FEM)
'animal (vulgar)'

The difference in agreement between a common gender noun *zv'er'-úg-a* 'animal (vulgar)' and a masculine noun *zv'er'* 'animal' is shown below. In (39), *zv'er'-úg-a* triggers either masculine or feminine agreement. In (40), *zv'er'* 'animal' can only trigger masculine agreement.

- (39) a. *bol'sh-ój* *zv'er'-úg-a*
big-ADJ.MASC.SG *animal-EXPR-N.SG (MASC)*
'big animal (vulgar)'
- b. *bol'sh-ája* *zv'er'-úg-a*
big-ADJ.FEM.SG *animal-EXPR-N.SG (FEM)*
'big animal (vulgar)'
- (40) a. *bol'sh-ój* *zv'er'*
big-ADJ.MASC.SG *animal.N.SG (MASC)*
'big animal'

- b. *bol'š-ája zv'ér'
big-ADJ.FEM.SG *animal.N.SG (FEM)*
 'big animal'

As I proposed above, common gender nouns are unspecified for grammatical gender. For this reason, they can trigger either masculine or feminine agreement. Thus, a change in grammatical gender should more precisely be described as a blocking of grammatical gender, when a masculine noun becomes unspecified for grammatical gender (41).

- (41) a. n [masculine]
 / \
 n [masculine] √zv'er'-
 (animate)
- b. n2 ← unspecified for grammatical gender
 / \
 n2 n1 [masculine]
 -ug / \
 n1 [masculine] √zv'er'-
 (animate)

The same effect of gender blocking is seen in (42). In (42a), the noun *tvár'* 'animal' is animate, because it denotes a living being. It is non-sex-differentiable (Type II), because it does not denote natural gender as part of its semantics (*tvár'* 'animal' denotes both male and female animals). The grammatical gender of this noun is feminine. In (42b), the attitude suffix *-úk* is added, which blocks grammatical gender of the base. The resulting noun *tvar'-úk-a* 'animal (vulgar)' is now in common gender.

- (42) a. *tvár'* b. *tvar'-úk-a*
animal.N.SG (FEM) *animal-EXPR-N.SG (MASC/FEM)*
 'animal' 'animal (vulgar)'

The difference in agreement between a common gender noun *tvar'-úk-a* 'animal (vulgar)' and a feminine noun *tvár'* 'animal' is shown below. In (43), *tvar'-úk-a* can trigger either masculine or feminine agreement, while in (44), *tvár'* can only trigger feminine agreement.

- (43) a. bol'š-ój tvar'-úk-a
big-ADJ.MASC.SG *animal-EXPR-N.SG (MASC)*
 'big animal (vulgar)'
- b. bol'š-ája tvar'-úk-a
big-ADJ.FEM.SG *animal-EXPR-N.SG (FEM)*
 'big animal (vulgar)'

- (44) a. bol'š-ája tvár'
big-ADJ.FEM.SG *animal.N.SG (FEM)*
 'big animal'
- b. *bol'š-ój tvár'
big-ADJ.MASC.SG *animal.N.SG (MASC)*
 'big animal'

Proposed structures for these data are shown in (45)–(46). In (45), the noun *tvár'* 'animal' is assigned feminine grammatical gender. In (46), the attitude suffix *-úk* is attached and it blocks grammatical gender of the base. As a result, the word *tvár'-úk-a* 'animal (vulgar)' triggers either masculine or feminine agreement.

- (45)
- ```

 n [feminine]
 / \
n [feminine] √tvár'-
 (animate)

```
- (46)
- ```

  n2
  /  \
n2    n1[feminine]
-uk   /  \
      n1[feminine]  √tvár'-
                       (animate)
  
```
- ← unspecified for grammatical gender

It is important to show that the blocking effects of grammatical gender also hold for data with nominalizing suffixes. In (47a), the noun *dur-ák* 'stupid animate' is formed by means of a productive nominalizing suffix *-ak* and is masculine. In (47b), the attitude suffix *-in* is added. As a result, the word *dur-ač'-ín-a* 'stupid animate (vulgar)' becomes a common gender noun.

- (47) a. **dur-ák** b. **dur-ač'-ín-a**
stupid-NOM.N.SG (MASC) *stupid-NOM-EXPR-N.SG (MASC/FEM)*
 'stupid animate' 'stupid animate (vulgar)'

The difference in agreement between a common gender noun *dur-ač'-ín-a* 'stupid animate (vulgar)' and a masculine noun *dur-ák* 'stupid animate' is shown below. In (48), *dur-ač'-ín-a* triggers either masculine or feminine agreement, while in (49), *dur-ák* can only trigger masculine agreement.

- (48) a. bol'š-ój dur-ač'-ín-a
big-ADJ.MASC.SG *stupid-NOM-EXPR-N.SG (MASC)*
 'very stupid animate (vulgar)'
- b. bol'š-ája dur-ač'-ín-a
big-ADJ.FEM.SG *stupid-NOM-EXPR-N.SG (FEM)*
 'very stupid animate (vulgar)'

- (49) a. bol'š-óĵ dur-ák
 big-ADJ.MASC.SG *stupid-NOM.N.SG (MASC)*
 'big stupid animate'
- b. *bol'š-ája dur-ák
 big-ADJ.FEM.SG *stupid-NOM.N.SG (FEM)*
 'big stupid animate'

Proposed structures for these data are given in (50)–(51). In (50), the noun *dur-ák* 'stupid animate' is assigned masculine grammatical gender. In (51), the attitude suffix *-in* blocks this gender creating an unspecified noun *dur-ač'-in-a* 'stupid animate (vulgar)'.

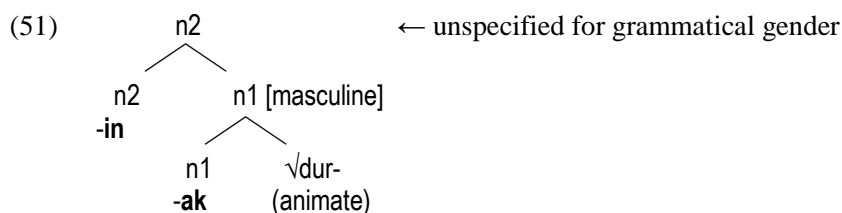
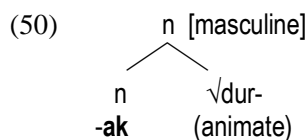

To summarize, Russian attitude suffixes block grammatical gender of Type II nouns (animate, non-sex-differentiable). Nouns that are used with attitude suffixes are always in common gender, regardless of grammatical gender of the input (Table 6).

Table 6

Attitude suffixes (used with Type II nouns)

EXPR _{attitude}	Input	Output
-án', -ás', -ón, -úl', -ún', -úr, -ús', -úš', -ág, -ák, -ál, -ár, -áx, -íl, -in, -ób, -ot, -óx, -úg, -úk, -úx	animate, [masculine]	animate, unspecified
	animate, [feminine]	animate, unspecified

For consistency, I will show that nouns of the remaining two types (Type I and Type III) do not change grammatical gender when attitude suffixes are attached. I start by looking at Type I nouns (animate, sex-differentiable).

Type I nouns denote natural gender as part of their semantics. As natural gender determines grammatical gender, male nouns are always masculine and female nouns are always feminine. When attitude suffixes merge with these nouns, the nouns remain semantically male or female, and therefore, there is no change in gender (including blocking effects). This is illustrated in the data in (52)–(55).

For example, in (52), the noun *s'estr-á* 'sister' is sex-differentiable because the natural gender 'female' is part of its semantics. When the attitude suffix *-úx* is attached, the resulting noun *s'estr-úx-a* 'sister (vulgar)' is still semantically female, and therefore, it is feminine. In (53), the noun *sín* 'son' is sex-differentiable because the natural gender 'male' is part of its semantics. When the attitude suffix *-úl'* is added, the resulting noun *sin-úl'-a* 'son (affectionate)' remains semantically male, and therefore, it is masculine.

- | | | | |
|---------|---------------------------------------------------------|----|--------------------------------------------------------------------------|
| (52) a. | <i>s'estr-á</i>
<i>sister-N.SG (FEM)</i>
'sister' | b. | <i>s'estr-úx-a</i>
<i>sister-EXPR-N.SG (FEM)</i>
'sister (vulgar)' |
| (53) a. | <i>sín</i>
<i>son-N.SG (MASC)</i>
'son' | b. | <i>sin-úl'-a</i>
<i>son-EXPR-N.SG (MASC)</i>
'son (affectionate)' |
| (54) a. | <i>d'év-a</i>
<i>girl-N.SG (FEM)</i>
'girl' | b. | <i>d'év-áx-a</i>
<i>girl-EXPR-N.SG (FEM)</i>
'girl (vulgar)' |
| (55) a. | <i>pár'en'</i>
<i>guy-N.SG (MASC)</i>
'guy' | b. | <i>parn'-úg-a</i>
<i>guy-EXPR-N.SG (MASC)</i>
'guy (vulgar)' |

Proposed structures for the data above are given in (56)–(57). In (56), the attitude suffix *-úx* does not block grammatical gender of the noun because the natural gender 'female' is part of the semantics of the $\sqrt{\text{Root } s'estr-}$ and it determines feminine grammatical gender. In (57), the attitude suffix *-úl'* also does not block the grammatical gender of the noun because the natural gender 'male' is part of the semantics of the $\sqrt{\text{Root } sin-}$ and it determines masculine grammatical gender.

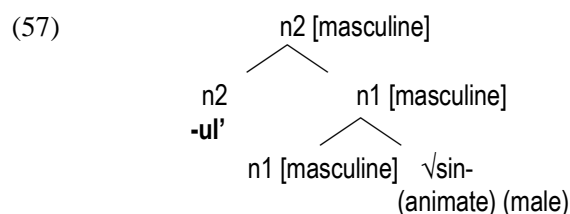
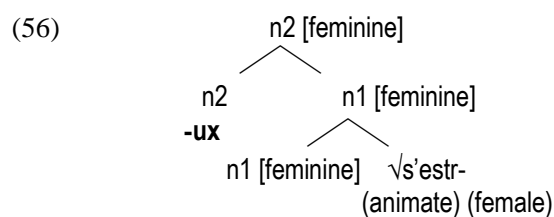

Another way to analyze the data in (52)–(53) would be to show that attitude suffixes merge directly with $\sqrt{\text{Roots}}$, and not with nouns (54)–(55). However, for the current analysis of grammatical gender this does not make a difference, since the output gender, as well as the dependency of grammatical gender upon natural gender, remain the same under either analysis.

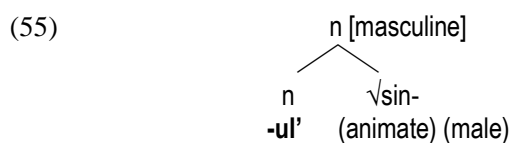
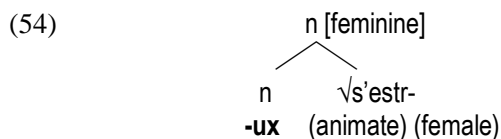

To summarize, attitude suffixes do not block grammatical gender of Type I nouns (animate, sex-differentiable) (Table 7).

Table 7

Attitude suffixes (used with Type I nouns)

EXPR _{attitude}	Input	Output
-án', -áš, -ón, -úl', -ún', -úr, -ús', -úš, -ág, -ák, -ál, -ár, -áx, -íl, -in, -ób, -ot, -óx, -úg, -úk, -úx	animate, male, [masculine]	animate, male, [masculine]
	animate, female, [feminine]	animate, female, [feminine]

Let us now consider Type III nouns (common gender). Type III nouns are unspecified for grammatical gender and can trigger either masculine or feminine agreement. When attitude suffixes attach to such nouns, they remain unspecified for gender, and therefore, there is no change (and no blocking effects) of grammatical gender. For example, in (56), the word *s'iroť-á* 'orphan' is a common gender noun. In (57), the attitude suffix *-in* is attached, which this does not produce a change in gender. The resulting noun *s'iroť-in-a* 'orphan (vulgar)' is still in common gender.

- (56) a. bol's-ój s'iroť-á
big-ADJ-MASC.SG orphan-N.SG (MASC)
 'big orphan'
- b. bol's-ájja s'iroť-á
big-ADJ-FEM.SG orphan-N.SG (FEM)
 'big orphan'
- (57) a. bol's-ój s'iroť-in-a
big-ADJ-MASC.SG orphan-EXPR-N.SG (MASC)
 'big orphan'

- b. bol'š-ája s'iroť'-**ín**-a
big-ADJ-FEM.SG orphan-EXPR-N.SG (FEM)
 'big orphan'

The proposed structure for *s'iroť'-ín-a* 'orphan (vulgar)' is given in (58). The attitude suffix *-in* merges with a common gender noun which is unspecified for grammatical gender. The resulting noun is also unspecified for grammatical gender.

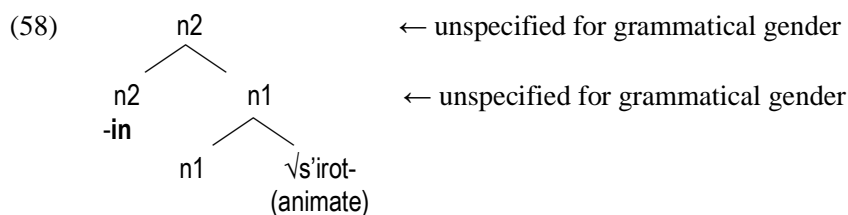

As in the cases with sex-differentiable nouns described above, the noun *s'iroť'-ín-a* 'orphan (vulgar)' can be analyzed in a different way: the attitude suffix *-in* merges directly with the $\sqrt{\text{Root}}$ *s'iroť-* (59). As in the cases above, this does not make a difference for the current analysis of grammatical gender because the output gender is still the same.

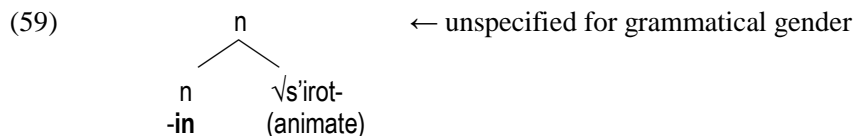

To summarize, attitude suffixes do not change grammatical gender of Type III nouns (common gender nouns) (Table 8).

Table 8

Attitude suffixes (used with Type III nouns)

EXPR _{attitude}	Input	Output
-án', -áš, -ón, -úl', -ún', -úr, -ús', -úš, -ág, -ák, -ál, -ár, -áx, -íl, -in, -ób, -ot, -óx, -úg, -úk, -úx	animate, unspecified	animate, unspecified

To conclude, attitude suffixes produce a change in grammatical gender of Type II nouns (animate, non-sex-differentiable). The change is seen in blocking effects of grammatical gender. When attitude suffixes merge with Type II nouns, the resulting words become Type III nouns (animate, common gender). When attitude suffixes merge with Type I (animate, sex-differentiable) or Type III nouns, there is no change in grammatical gender (Table 9: change in grammatical gender is indicated in **bold**).

Table 9
Attitude suffixes (animate nouns)

	Input	Output
EXPR _{attitude}	Type I (animate, sex-differentiable)	Type I (animate, sex-differentiable)
	Type II (animate, non-sex-differentiable)	Type III (animate, common gender)
	Type III (animate, common gender)	Type III (animate, common gender)

The question of why attitude suffixes produce different effects in grammatical genders will be dealt with in §4 (change in inflectional class). In §4, I argue that Russian attitude suffixes are inherently specified for inflectional class and that the differences in grammatical genders fall out directly from their inflectional class.

3.1.2 Inanimate nouns

Let us now look at inanimate nouns to understand whether attitude suffixes produce any change in grammatical gender of these nouns. Inanimate nouns can have masculine, feminine, or neuter grammatical genders in Russian (60). For example, *žurnál* ‘magazine’ is masculine, *gaz’ét-a* ‘newspaper’ is feminine, and *p’is’-m-ó* ‘letter’ is neuter.

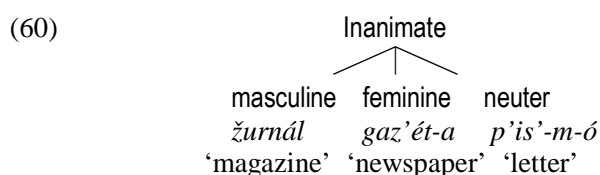

Here I show that attitude suffixes produce a change in grammatical gender of inanimate nouns. The majority of attitude suffixes (with the exception of *-án*) create feminine nouns, regardless of grammatical gender of the input. The attitude suffix *-án* creates masculine nouns regardless of grammatical gender of the input.

I start by analyzing attitude suffixes that form feminine nouns. For example, the attitude suffix *-in* can attach to nouns of all grammatical genders (masculine, feminine, neuter). In every case, it forms a feminine noun. In (61), a masculine noun *ovrág* ‘ditch’ becomes feminine when the attitude suffix *-in* is added. In (62), a feminine noun *jám-a* ‘ditch’ remains feminine when *-in* is added. In (63), a neuter noun *bolót-o* ‘swamp’ becomes feminine when the suffix *-in* is added.

- | | |
|----------------------------------------------------------------------|-----------------------------------------------------------------------------------|
| <p>(61) a. <i>ovrág</i>
<i>ditch.N.SG (MASC)</i>
‘ditch’</p> | <p>b. <i>ovráž-in-a</i>
<i>ditch-EXPR-N.SG (FEM)</i>
‘ditch (vulgar)’</p> |
| <p>(62) a. <i>jám-a</i>
<i>pit-N.SG (FEM)</i>
‘pit’</p> | <p>b. <i>jám-in-a</i>
<i>pit-EXPR-N.SG (FEM)</i>
‘pit (vulgar)’</p> |

- (63) a. bolót-o
swamp-N.SG (NEUT)
 ‘swamp’
- b. bolót’-in-a
swamp-EXPR-N.SG (FEM)
 ‘swamp (vulgar)’

Structures for the data above are given in (64)–(66).

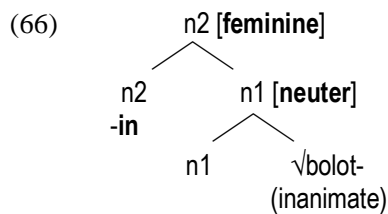
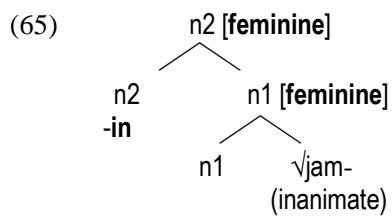
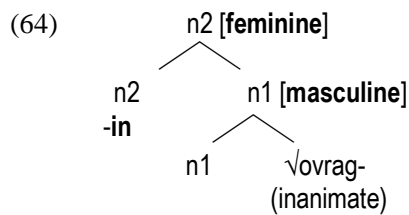

More examples that show that attitude suffixes form feminine nouns are given in (67)–(70).

- (67) a. sm’*é*x
laughter.N.SG (MASC)
 ‘laughter’
- b. sm’*ex-ot-á*
laughter-EXPR-N.SG (FEM)
 ‘laughter (vulgar)’
- (68) a. skúk-a
boredom-N.SG (FEM)
 ‘boredom’
- b. skuk-*ot-á*
boredom-EXPR-N.SG (FEM)
 ‘boredom (vulgar)’
- (69) a. stíd
shame.N.SG (MASC)
 ‘shame’
- b. stid-*úx-a*
shame-EXPR-N.SG (FEM)
 ‘shame (vulgar)’
- (70) a. kómnat-a
room-N.SG (FEM)
 ‘room’
- b. komnat-*úx-a*
room-EXPR-N.SG (FEM)
 ‘room (vulgar)’

Unlike the majority of attitude suffixes, the attitude suffix *-án* forms nouns of masculine gender. For example, in (71), the noun *lób* ‘forehead’ is masculine. When the suffix *-án* is attached, the resulting noun *lob-án* is also masculine. In (72), the noun *gub-á* ‘lip’ is feminine. When the attitude suffix *-án* is attached, the resulting noun *gub-án* becomes masculine. In (73), the noun *púz-o* ‘belly’ is neuter. When *-án* is attached, the resulting noun *puz-án* also becomes masculine.

- | | | | |
|---------|--------------------------------------------------|----|-----------------------------------------------------------------------------------------|
| (71) a. | lób
<i>forehead.N.SG (MASC)</i>
‘forehead’ | b. | lob-án
<i>forehead-EXPR.N.SG (MASC)</i>
‘animate with distinct forehead (vulgar)’ |
| (72) a. | gub-á
<i>lip-N.SG (FEM)</i>
‘lip’ | b. | gub-án
<i>lip-EXPR.N.SG (MASC)</i>
‘animate with distinct lips (vulgar)’ |
| (73) a. | púz-o
<i>belly-N.SG (NEUT)</i>
‘belly’ | b. | puz-án
<i>belly-EXPR.N.SG (MASC)</i>
‘animate with distinct belly (vulgar)’ |

Proposed structures for (71)–(73) are given in (74)–(76).

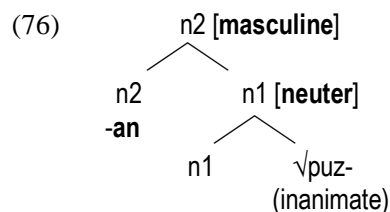
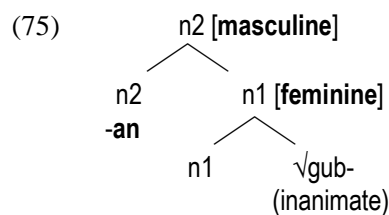
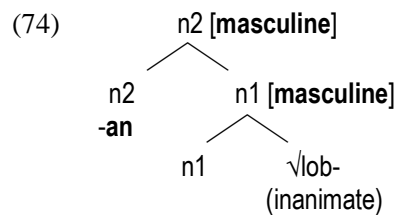

To conclude, attitude suffixes change grammatical gender of inanimate nouns. Most attitude suffixes (except *-án*) form feminine nouns, regardless of the gender of the input. The attitude suffix *-án* forms masculine nouns, regardless of the gender of the input (Table 10: change in grammatical gender is indicated in **bold**).

Table 10

Attitude suffixes (inanimate nouns)

EXPR _{attitude}	Input	Output
<i>-án', -áš, -ón, -úl', -ún', -úr, -ús', -úš, -ág, -ák, -ál, -ár, -áx, -íl, -in, -ób, -ot, -óx, -úg, -úk, -úx</i>	inanimate, [masculine]	inanimate, [feminine]
	inanimate, [neuter]	inanimate, [feminine]
	inanimate, [feminine]	inanimate, [feminine]
<i>-án</i>	inanimate, [masculine]	inanimate, [masculine]
	inanimate, [neuter]	inanimate, [masculine]
	inanimate, [feminine]	inanimate, [masculine]

3.1.3 Summary

Attitude suffixes produce a change in grammatical gender which depends on animacy and natural gender of the $\sqrt{\text{Root}}$. The change is seen in animate non-sex-differentiable nouns (Type II) that become common gender nouns, unspecified for grammatical gender (Type III). The change is also seen in inanimate nouns that become either feminine (with the majority of attitude suffixes) or masculine (with the attitude suffix *-án*) (Table 11).

Table 11

Attitude suffixes (change in grammatical gender)

EXPR _{attitude}	Input	Output
<i>-án', -áš, -ón, -úl', -ún', -úr, -ús', -úš, -ág, -ák, -ál, -ár, -áx, -íl, -in, -ób, -ot, -óx, -úg, -úk, -úx</i>	animate (non-sex-differentiable), any input	animate (non-sex-differentiable), unspecified
	inanimate, any input	inanimate, [feminine]
<i>-án</i>	inanimate, any input	inanimate, [masculine]

According to Diagnostic II (change in grammatical gender), attitude suffixes behave like syntactic heads because they produce a change in grammatical gender (77).

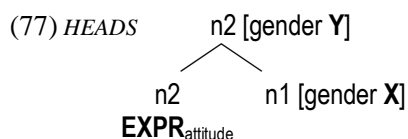

Based on these findings, the following question arises: Why is there variation in grammatical gender of nouns that are used with attitude suffixes? If attitude suffixes changed grammatical gender by assigning it, we would expect no variation. On the other hand, if attitude suffixes do not assign grammatical gender, what determines a change in gender? Later (§4) I will argue that attitude suffixes do not assign grammatical gender, but instead they assign inflectional class. I will show that inflectional class determines a change in grammatical gender, which accounts for the variation in gender observed above.

3.2 Size suffixes

Unlike attitude suffixes that can change grammatical gender of a noun, size suffixes do not produce a change in gender. Size suffixes can attach to both animate and inanimate nouns of all grammatical genders with the same result: no change in gender. The evidence is provided below.

Let us first look at animate Type I nouns (sex-differentiable). As I discussed above, these nouns denote natural sex (male or female) as part of their semantics. When size suffixes attach to Type I nouns, there is no change in grammatical gender. For example, in (78), the noun *brát* ‘brother’ is sex-differentiable because natural gender ‘male’ is encoded in its meaning. As males are always masculine, the noun *brát* ‘brother’ is assigned masculine grammatical gender. When the size suffixes *-ik* and *-ec* are added to this noun, there is no change in gender. The resulting nouns *brát’-ik* ‘brother (dim)’ and *brát’-ec* ‘brother (dim)’ are still masculine.

- (78) a. *brát*
brother.N.SG (MASC)
 ‘brother’
- b. *brát’-ik*
brother-EXPR.N.SG (MASC)
 ‘brother (diminutive)’
- c. *brát’-ec*
brother-EXPR.N.SG (MASC)
 ‘brother (diminutive)’

A structure for (78) is given in (79).

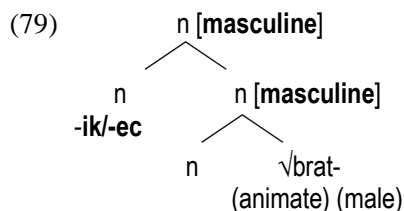

Another example of a sex-differentiable noun is given in (80). The noun *s'estr-á* 'sister' denotes natural gender 'female' as part of its meaning. As females are always feminine, the noun *s'estr-á* 'sister' is assigned feminine grammatical gender. When the size suffix *-ic* is added, there is no change in gender and the resulting noun *s'estr'-íc-a* 'sister (dim)' remains feminine.

- (80) a. *s'estr-á*
sister-N.SG (FEM)
 'sister'
- b. *s'estr'-íc-a*
sister-EXPR-N.SG (FEM)
 'sister (diminutive)'

A structure for (80) is given in (81).

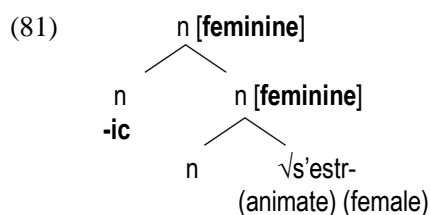

Let us now look at animate Type II nouns (non-sex-differentiable). Nouns of this type do not denote natural gender as part of their semantics. Here I show that when size suffixes attach to Type II nouns, there is also no change in grammatical gender. For example, in (82), the noun *zv'ér* 'animal' is non-sex-differentiable because it denotes both male and female animals. The noun *zv'ér* 'animal' is assigned masculine grammatical gender. When the size suffixes *-ok* and *-išč'* merge with this noun, there is no change in gender. The resulting nouns *zv'er'-ók* 'animal (dim)' and *zv'er'-išč'-e* 'animal (aug)' are still masculine.

- (82) a. *zv'ér*
animal.N.SG (MASC)
 'animal'
- b. *zv'er'-ók*
animal-EXPR.N.SG (MASC)
 'animal (diminutive)'
- c. *zv'er'-išč'-e*
animal-EXPR-N.SG (MASC)
 'animal (augmentative)'

A structure for (82) is given in (83). The noun *zv'ér* 'animal' is masculine and does not change gender when the size suffixes *-ok* and *-išč'* are attached.

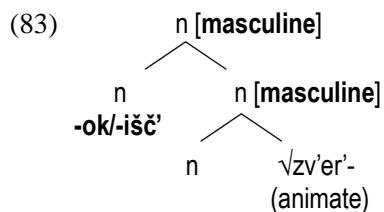

Another example of a non-sex-differentiable noun is shown in (84). The noun *ríb-a* ‘fish’ is assigned feminine grammatical gender. When the size suffixes *-k*, *-ic*, and *-išč* merge with this noun, there is no change in gender. The resulting nouns *ríb-k-a* ‘fish (dim)’, *ríb-ic-a* ‘fish (dim)’, and *ríb-išč-a* ‘fish (aug)’ are still feminine.

- (84) a. *ríb-a*
fish-N.SG (FEM)
‘fish’
- b. *ríb-k-a*
fish-EXPR-N.SG (FEM)
‘fish (diminutive)’
- c. *ríb-ic-a*
fish-EXPR-N.SG (FEM)
‘fish (diminutive)’
- b. *ríb-išč-a*
fish-EXPR-N.SG (FEM)
‘fish (augmentative)’

A structure for (84) is in (85). The noun *ríb-a* ‘fish’ is feminine and does not change gender when the size suffixes *-k*, *-ic*, and *-išč* are attached.

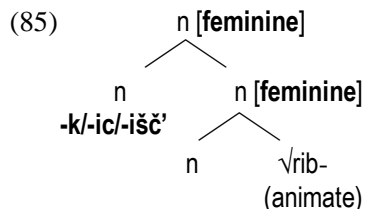

We have discussed animate nouns of Type I and Type II, and we have illustrated that size suffixes do not change grammatical gender of these nouns. One more type of animate noun that remains to be discussed is Type III (common gender nouns).

I show that size suffixes produce no change in grammatical gender of Type III nouns. For example, in (86), the noun *s’irot-á* ‘orphan’ is a common gender noun because it can trigger either masculine or feminine agreement (MASC/FEM). When the size suffix *-k* merges with this noun, there is no change in gender. The resulting noun *s’irot-k-a* ‘orphan (dim)’ is still a common gender noun that can trigger either masculine or feminine agreement.

- (86) a. *s’irot-á*
orphan-N.SG (MASC/FEM)
‘orphan’
- b. *s’irot-k-a*
orphan-EXPR-N.SG (MASC/FEM)
‘orphan (diminutive)’

A structure for (86) is given in (87). The noun *s’irot-á* ‘orphan’ is unspecified for grammatical gender. When the size suffix *-k* merges with this noun, there is no change in grammatical gender. The resulting noun is still unspecified and can trigger either masculine or feminine agreement.

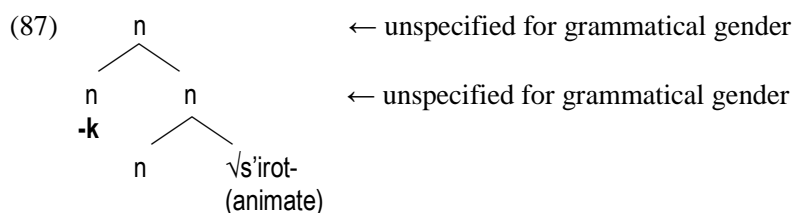

So far, I have analyzed different types of animate nouns. I have illustrated that there is no change in grammatical gender of animate nouns when size suffixes are added. Below I propose an analysis of inanimate nouns and show that size suffixes do not produce a change in grammatical gender of inanimate nouns.

Let us look at inanimate nouns of different grammatical genders (masculine, feminine, and neuter). In (88), *l'és* 'forest' is masculine. When the size suffixes *-ok* and *-išč'* are added, there is no change in grammatical gender. The resulting nouns *l'es-ók* 'forest (dim)' and *l'es-išč'-e* 'forest (aug)' are still masculine.

- (88) a. *l'és*
forest-N.SG (MASC)
'forest'
- b. *l'es-ók*
forest-EXPR-N.SG (MASC)
'forest (diminutive)'
- c. *l'es-išč'-e*
forest-EXPR-N.SG (MASC)
'forest (augmentative)'

A proposed structure for (88) is given in (89). The noun *l'és* 'forest' is assigned masculine gender and does not change gender when the size suffixes *-ok* and *-išč'* are attached.

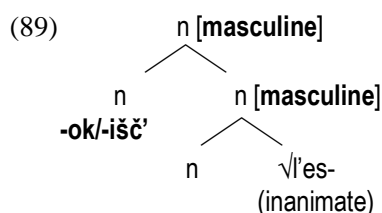

In (90), *róšč'-a* 'grove' is feminine. When the size suffix *-ic* is added, there is no change in grammatical gender. The resulting noun *róšč'-ic-a* 'grove (dim)' is still feminine.

- (90) a. *róšč'-a*
grove-N.SG (FEM)
'grove'
- b. *róšč'-ic-a*
grove-EXPR-N.SG (FEM)
'grove (diminutive)'

A structure for (90) is given in (91).

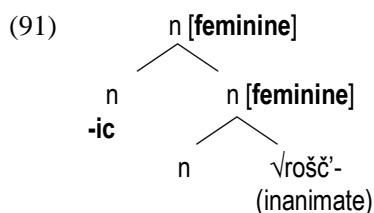

In (92), *bolót-o* 'swamp' is neuter. When the size suffixes *-c* and *-išč'* are added, there is no change in grammatical gender. The resulting nouns *bolót-c-e* 'swamp (dim)' and *bolót'-išč'-e* 'swamp (aug)' are still neuter.

- (92) a. *bolót-o*
swamp-N.SG (NEUT)
 'swamp'
- b. *bolót-c-e*
swamp-EXPR-N.SG (NEUT)
 'swamp (diminutive)'
- c. *bolót'-išč'-e*
swamp-EXPR-N.SG (NEUT)
 'swamp (augmentative)'

A structure for (92) is given in (93).

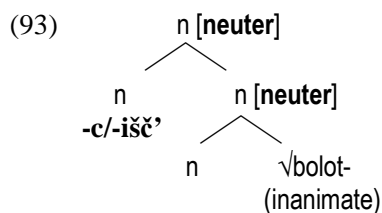

To summarize, size suffixes produce no change in grammatical gender of both animate and inanimate nouns (Table 12).

Table 12

Size suffixes (No change in grammatical gender)

EXPR _{size}	Input	Output
-k/-ek/-ok/-ik; -c/-ec/-ic; -išč'	animate, male, [masculine]	animate, male, [masculine]
	animate, female, [feminine]	animate, female, [feminine]
	animate, [masculine]	animate, [masculine]
	animate, [feminine]	animate, [feminine]
	inanimate, [masculine]	inanimate, [masculine]
	inanimate, [feminine]	inanimate, [feminine]
	inanimate, [neuter]	inanimate, [neuter]

4.1 Attitude suffixes

Here I show that the majority of attitude suffixes (except *-án*) form nouns of inflectional class II, regardless of the inflectional class of the input (97a). The attitude suffix *-án* forms nouns of inflectional class I, regardless of the inflectional class of the input (97b).

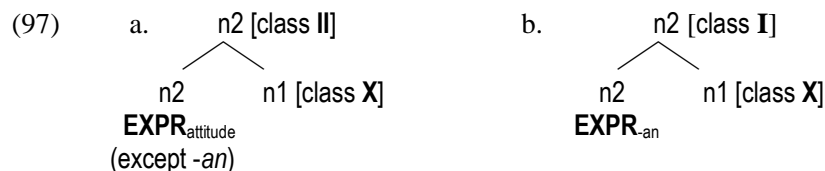

The inflectional classes of Russian are indicate as follows:

- Class I: $-\emptyset$ word ending in the Nominative case
 Class II: $-a$ word ending in the Nominative case

In §4.1.1, I illustrate how attitude suffixes change inflectional class of a noun; in §4.1.2, I show that a change in inflectional class is correlated with a change in grammatical gender.

4.1.1 Change in inflectional class

Let us start by looking at attitude suffixes that form nouns of inflectional class II (98)–(101). For example, in (98), *st'íd* 'shame' belongs to class I, which is evident from the $-\emptyset$ ending in the Nominative case. When the attitude suffix *-ób* is added, there is a change in inflectional class. The resulting noun *stid-ób-a* 'shame (vulgar)' is now in class II ($-a$ ending in the Nominative case).

- (98) a. *stíd*
shame.N.SG (MASC; CLASS I)
 'shame'
- b. *stid-ób-a*
shame-EXPR-N.SG (FEM; CLASS II)
 'shame (vulgar)'

In (99), *č'elov'ék* 'person' belongs to class I. When the attitude suffix *-in* is added, there is a change in inflectional class. The resulting noun *č'elov'éc'-in-a* 'person (vulgar)' is now in class II.

- (99) a. *č'elov'ék*
person.N.SG (MASC; CLASS I)
 'person'
- b. *č'elov'éc'-in-a*
person-EXPR-N.SG (MASC/FEM; CLASS II)
 'person (vulgar)'

In (100), *báb-a* 'woman' belongs to class II. When the attitude suffix *-óx* is added, there is no change in inflectional class. The resulting noun *bab'-óx-a* 'woman (vulgar)' is still in class II.

- (100) a. *báb-a*
woman-N.SG (FEM; CLASS II)
 ‘woman’¹
- b. *bab’-óx-a*
woman-EXPR-N.SG (FEM; CLASS II)
 ‘woman (vulgar)’

In (101), *páp-a* ‘dad’ belongs to class II. When the attitude suffix *-ús’* is added, there is no change in inflectional class. The resulting noun *pap-ús’-a* ‘dad (affect)’ remains in class II.

- (101) a. *páp-a*
dad-N.SG (MASC; CLASS II)
 ‘dad’
- b. *pap-ús’-a*
dad-EXPR-N.SG (MASC; CLASS II)
 ‘dad (affectionate)’

Structures for (98) and (100) are given in (102)–(103). In (102), the noun *stíd* ‘shame’ is in inflectional class I. When the size suffix *-ób* is attached, the inflectional class changes to class II. In (103), the noun *báb-a* ‘woman’ is in inflectional class II. When the size suffix *-óx* is attached, there is no change in inflectional class. In other words, no matter what the inflectional class of the input, these attitude suffixes always form nouns of class II.

- (102) a.
- ```

 n2 [class II]
 / \
 n2 n1 [class I]
 -ob / \
 n1 √stid-

```

- (103) a.
- ```

      n2 [class II]
     /  \
    n2   n1 [class II]
  -ox   /  \
        n1  √bab-
  
```

In contrast, the attitude suffix *-án* forms nouns of class I. This is shown in (104)–(108). In (104), *gub-á* ‘lip’ belongs to class II. When the attitude suffix *-án* is added, there is a change in inflectional class. The resulting noun *gub-án* ‘animate with distinct lips (vulgar)’ is now in class I.

- (104) a. *gub-á*
lip-N.SG (FEM; CLASS II)
 ‘lip’
- b. *gub-án*
lip-EXPR.N.SG (MASC; CLASS I)
 ‘animate with distinct lips (vulgar)’

In (105), *mal’-č’-úg-a* ‘boy (vulgar)’ belongs to class II. When the attitude suffix *-án* is added, there is a change in inflectional class. The resulting noun *mal’-č’-ug-án* ‘boy (vulgar)’ is now in class I.

¹ In Contemporary Standard Russian, *báb-a* ‘woman’ has a downgrading meaning when referring to a woman. For a neutral meaning, *ženšč’-in-a* ‘woman’ is used.

- (105) a. mal'-č'-úg-a
small-NOM-EXPR-N.SG (MASC; **CLASS II**)
 'boy (vulgar)'
- b. mal'-č'-ug-án
small-NOM-EXPR-EXPR.N.SG (MASC; **CLASS I**)
 'boy (vulgar)'

In (106), *brát* 'brother' is in class I. When the attitude suffix *-an* is added, there is no change in inflectional class. The resulting noun *brat-án* 'brother (vulgar)' is still in class I.

- (106) a. brát
brother N.SG (MASC; **CLASS I**)
 'brother'
- b. brat-án
brother-EXPR.N.SG (MASC; **CLASS I**)
 'brother (vulgar)'

In (107), *star'-ík* 'old man' belongs to class I. When the attitude suffix *-án* is added, there is no change in inflectional class. The resulting noun *star'-ik-án* 'old man (vulgar)' remains in class I.

- (108) a. star'-ík
old-NOM.N.SG (MASC; **CLASS I**)
 'old man'
- b. star'-ik-án
old-NOM-EXPR.N.SG (MASC; **CLASS I**)
 'old man (vulgar)'

Structures for (104) and (106) are shown below. In (109), the noun *gub-á* 'lip' is in inflectional class II. When the suffix *-án* is attached, the inflectional class changes to class I. In (110), the noun *brát* 'brother' is in inflectional class I. When the suffix *-án* is attached, there is no change in inflectional class. In other words, no matter what the inflectional class of the input, the attitude suffix *-án* always forms nouns of class I.

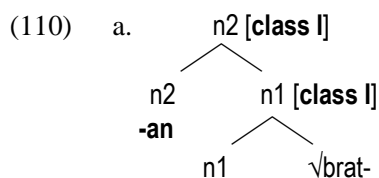
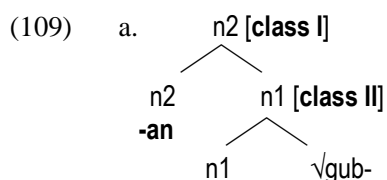

To summarize, the majority of attitude suffixes (except *-án*) form nouns of class II, regardless of the inflectional class of the input. The attitude suffix *-án* forms nouns of class I, no matter what the class of the input (Table 14: change in inflectional class is indicated in **bold**).

Table 14

Attitude suffixes (change in the inflectional class)

EXPR _{attitude}	Input	Output
-án', -áš, -ón, -úl', -ún', -úr, -ús', -úš, -ág, -ák, -ál, -ár, -áx, -íl, -in, -ób, -ot, -óx, -úg, -úk, -úx	Class I	Class II
	Class II	Class II
-án	Class II	Class I
	Class I	Class I

4.1.2 Correlation between a change in class and a change in grammatical gender

In §3.1, I showed that there is variation in grammatical gender of nouns used with attitude suffixes. Here I argue that this variation is determined by the inflectional class assigned by an attitude suffix. In other words, attitude suffixes are specified for inflectional class, and grammatical gender falls out directly from this inflectional class. I propose that the majority of attitude suffixes (except *-án*) are specified for inflectional class II (111a). The attitude suffix *-án* is specified for inflectional class I (111b).

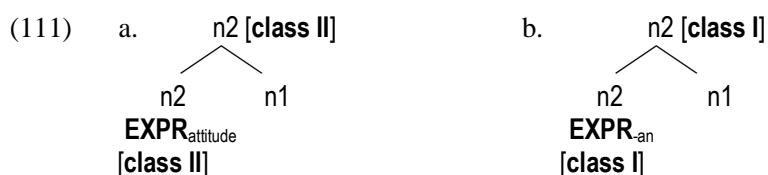

Let us start by revisiting the data with variation in grammatical gender. When attitude suffixes are added to animate sex-differentiable nouns, the resulting nouns are masculine or feminine, depending on the natural gender of the original noun. For example, in (112), the attitude suffix *-úx* is added to the noun *brát* 'brother' with the natural gender 'male'. As a result, the noun *brat-úx-a* 'brother (vulgar)' is masculine. In (113), the same attitude is added to *s'estr-á* 'sister' with the natural gender 'female'. As a result, the noun *s'estr-úx-a* 'sister (vulgar)' is feminine.

- (112) a. *brát*
brother.N.SG (MASC; CLASS I)
'brother'
- b. *brat-úx-a*
brother-EXPR-N.SG (MASC; CLASS II)
'brother (vulgar)'
- (113) a. *s'estr-á*
sister.N.SG (FEM; CLASS II)
'sister'
- b. *s'estr-úx-a*
sister-EXPR-N.SG (FEM; CLASS II)
'sister (vulgar)'

When attitude suffixes are added to inanimate nouns, the resulting nouns become feminine. For example, in (114), the attitude suffix *-úx* is added to *gólod* 'hunger' which is a masculine noun. The resulting noun *golod-úx-a* 'hunger (vulgar)' becomes feminine.

- (114) a. *gólod*
hunger.N.SG (MASC; CLASS I)
 ‘hunger’
- b. *golod-úx-a*
hunger-EXPR-N.SG (FEM; CLASS II)
 ‘hunger (vulgar)’

When attitude suffixes are added to animate non-sex-differentiable nouns, the resulting nouns become unspecified for gender (common gender nouns). For example, in (115), the attitude suffix *-úg* is added to *zv’ér’* ‘animal’, which is a masculine noun. As a result, the noun *zv’er’-úg-a* ‘animal (vulgar)’ becomes unspecified for gender (MASC/FEM).

- (115) a. *zv’ér’*
animal.N.SG (MASC; CLASS I)
 ‘animal’
- b. *zv’er’-úg-a*
animal-EXPR-N.SG (MASC/FEM; CLASS I)
 ‘animal (vulgar)’

I propose that this variation in grammatical genders falls out directly from the inflectional class of an attitude suffix. Let us first analyze the majority of attitude suffixes that assign inflectional class II. Russian class II nouns fall into two categories: animate and inanimate nouns. Animate nouns are sex-differentiable or non-sex-differentiable. Both sex-differentiable and non-sex-differentiable nouns can be either masculine or feminine; the difference being that grammatical gender of sex-differentiable ones is determined by their natural gender, ‘male’ or ‘female’. Inanimate nouns of this class are all feminine (116).

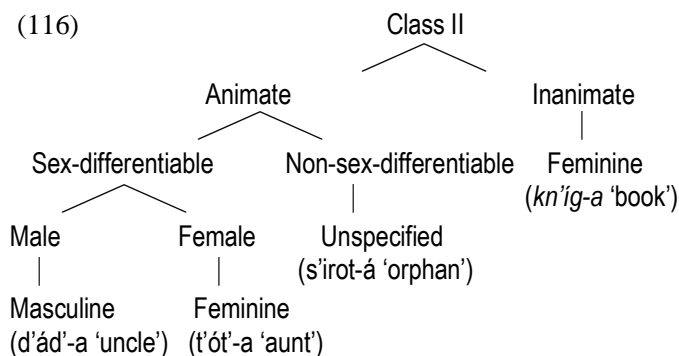

If attitude suffixes assigned class II, we would expect that animate nouns used with these suffixes could be either masculine or feminine depending on the natural gender of the $\sqrt{\text{Root}}$, while inanimate nouns could only be feminine. This prediction is correct. For example, in (112) above, *brát* ‘brother’ belongs to class I. When the attitude suffix *-úx* is added, the inflectional class changes to class II. Since $\sqrt{\text{brat-}}$ is ‘male’, the resulting noun *brat-úx-a* ‘brother (vulgar)’ is masculine. Thus, knowing animacy, natural gender, and inflectional class of the noun, it is possible to derive its grammatical gender. If a noun is animate, male, and belongs to class II, its grammatical gender is always [masculine] (117).

(117) a. (male) and [class II] → [masculine]

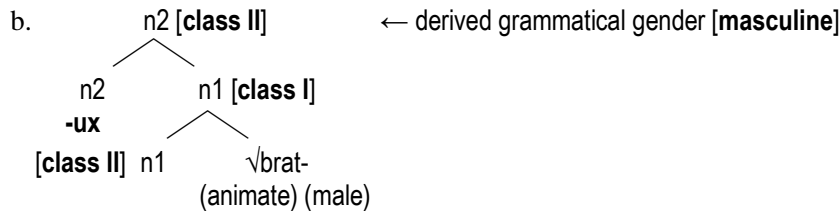

In (113), *s'estr-á* 'sister' belongs to inflectional class II. When the attitude suffix *-úx* is added, there is no change in class. The resulting noun *s'estr-úx-a* 'sister (vulgar)' is still in class II. Since $\sqrt{s'estr-}$ is 'female', the resulting noun *s'estr-úx-a* 'sister (vulgar)' is feminine. Here again, knowing animacy, natural gender, and inflectional class of a noun, it is possible to derive its grammatical gender. If a noun is animate, female, and belongs to class II, its grammatical gender is always [feminine] (118).

(118) a. (female) and [class II] → [feminine]

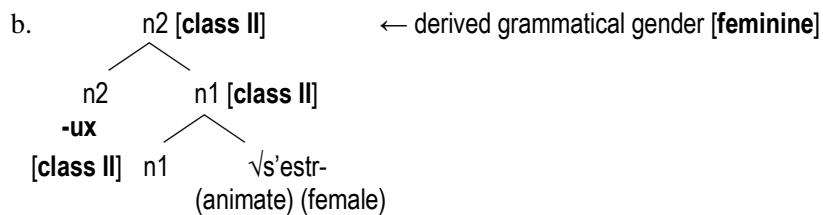

In (114), the same attitude suffix *-úx* is added to an inanimate noun *gólod* 'hunger'. The noun *gólod* 'hunger' belongs to inflectional class I. When the attitude suffix *-úx* is added, the inflectional class changes. The resulting noun *golod-úx-a* 'hunger (vulgar)' is now in class II. Since inanimate class II nouns are all feminine in Russian, it is possible to derive grammatical gender from inflectional class. Thus, if a noun is inanimate and belongs to class II, its grammatical gender is always [feminine] (119).

(119) a. (inanimate) and [class II] → [feminine]

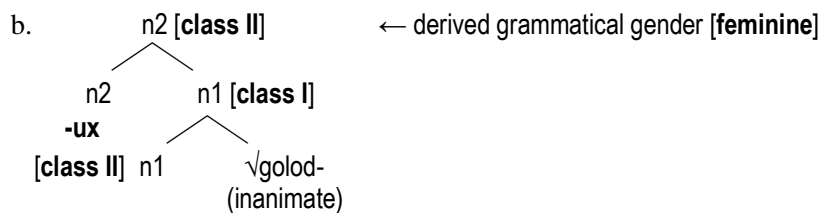

In (115), *zv'er'* 'animal' belongs to inflectional class I. When the attitude suffix *-úg* is added, there is a change in inflectional class. The resulting noun *zv'er'-úg-a* 'animal (vulgar)' is now in class II. Since $\sqrt{zv'er'}$ is animate, but it is non-sex-differentiable, its grammatical gender cannot be determined by natural gender. As a result, when it becomes a class II noun, its

grammatical gender is unspecified, which accounts for its status as a common gender noun. Thus, if a noun is animate, non-sex-differentiable, and belongs to class II, its grammatical gender is unspecified (120).

(120) a. (animate) and [class II] → unspecified gender

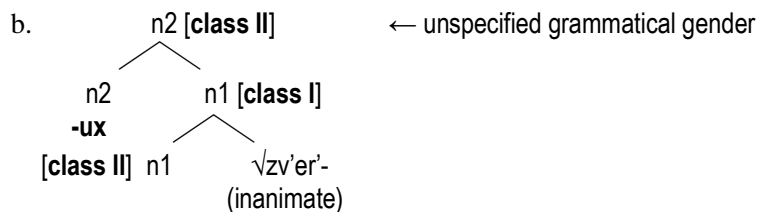

Let us now analyze the attitude suffix *-án*, which assigns inflectional class I. Russian class I nouns can be animate or inanimate. Animate nouns are masculine,² while inanimate nouns are either masculine or neuter (121).

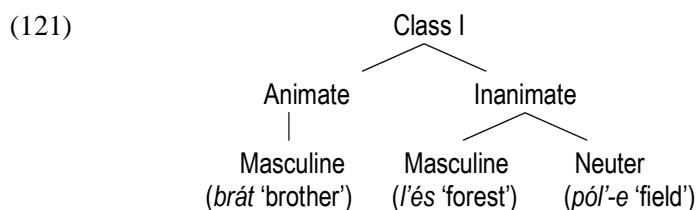

The attitude suffix *-án* can attach to both animate and inanimate nouns of different classes. As a result, it produces a change in both animacy and inflectional class of a noun. The resulting nouns are always animate and belong to class I. For example, in (122), *gub-á* 'lip' is an inanimate class II noun. When the attitude suffix *-án* is added, the resulting noun *gub-án* 'animate with distinct lips' becomes animate and changes to class I. In (123), *púz-o* 'belly' is an inanimate class I noun. When the attitude suffix *-án* is added, the resulting noun *puz-án* 'animate with distinct belly' becomes animate, and it remains in class I.

(122) a. *gub-á*
lip-N.SG (FEM; CLASS II)
 'lip'

b. *gub-án*
lip-EXPR.N.SG (MASC; CLASS I)
 'animate with distinct lips (vulgar)'

(123) a. *púz-o*
belly-N.SG (NEUT; CLASS I)
 'belly'

b. *puz-án*
belly-EXPR.N.SG (MASC; CLASS I)
 'animate with distinct belly (vulgar)'

I propose that the attitude suffix *-án* is specified for both animacy, and inflectional class I. As I have shown above, knowing animacy and inflectional class of a noun, it is possible to derive its grammatical gender. Let us see how this works in the data above. In (122), *gub-á* 'lip' is an inanimate feminine noun that belongs to class II. The suffix *-án* turns it into an

² There are two exceptions: *živót-n-oje* 'animal' and *nas'ekóm-oje* 'insect'.

animate noun of class I. The combination of animacy and class I automatically changes feminine gender to masculine, because all class I animate nouns are masculine in Russian (124).

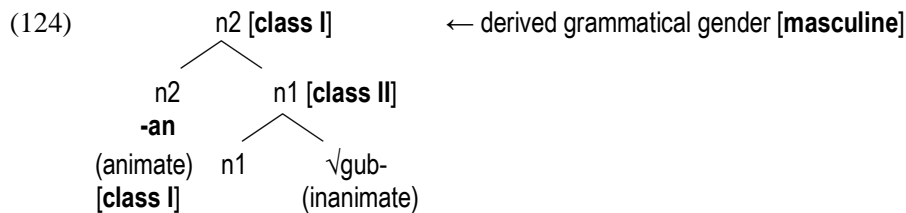

In (123), *púz-o* ‘belly’ is an inanimate neuter noun that belongs to class I. The suffix *-án* turns it into an animate noun of class I. Here, too, the combination of animacy and class I automatically changes neuter gender to masculine, because all class I animate nouns are masculine in Russian (125).

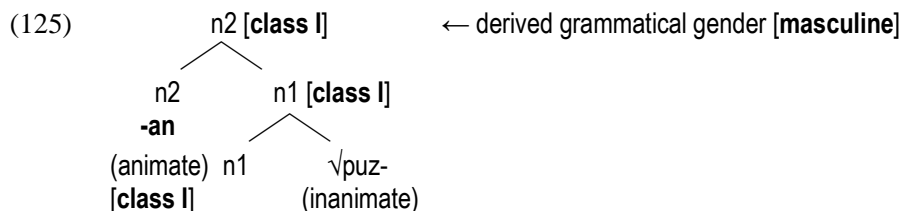

To summarize, I have argued that attitude suffixes are inherently specified for inflectional class. The majority of attitude suffixes (except *-án*) are specified for class II (126a). The suffix *-án* is specified for both animacy, and class I (126b). Knowing animacy, natural gender, and inflectional class of a noun, it is possible to derive its grammatical gender, which accounts for the variation in grammatical gender observed in the data.

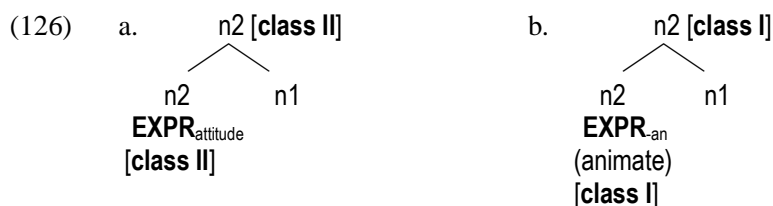

Since attitude suffixes produce a change in inflectional class, according to Diagnostic III, they behave like syntactic heads (127).

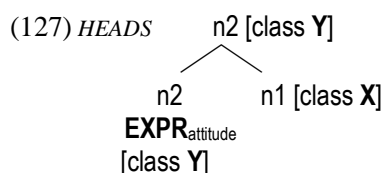

4.2 Size suffixes

In contrast to attitude suffixes, size suffixes do not produce a change in inflectional class. This is illustrated in (128)–(131). For example, in (128), the noun *č'elov'ék* 'person' belongs to class I. When the size suffixes *-ek* and *-išč'* are added, there is no change in inflectional class. The resulting nouns *č'elov'éc'-ek* 'person (dim)' and *č'elov'éc'-išč'-e* 'person (aug)' are still in class I.

- (128) a. *č'elov'ék*
person-N.SG (MASC; CLASS I)
'person'
- b. *č'elov'éc'-ek*
person-EXPR-N.SG (MASC; CLASS I)
'person (diminutive)'
- c. *č'elov'éc'-išč'-e*
person-EXPR-N.SG (MASC; CLASS I)
'person (augmentative)'

In (129), the noun *xl'éb* 'bread' is in class I. When the size suffix *-ec* is added, there is no change in inflectional class. The resulting noun *xl'éb'-ec* 'bread (dim)' remains in class I.

- (129) a. *xl'éb*
bread-N.SG (MASC; CLASS I)
'bread'
- b. *xl'éb'-ec*
bread-EXPR-N.SG (MASC; CLASS I)
'bread (diminutive)'

In (130), the noun *ruk-á* 'hand' belongs to class II. When the size suffixes *-k* and *-išč'* are added, there is no change in inflectional class. The resulting nouns *rúč'-k-a* 'hand (dim)' and *ruč'-išč'-a* 'hand (aug)' are still in class II.

- (130) a. *ruk-á*
hand-N.SG (FEM; CLASS II)
'hand'
- b. *rúč'-k-a*
hand-EXPR-N.SG (FEM; CLASS II)
'hand (diminutive)'
- c. *ruč'-išč'-a*
hand-EXPR-N.SG (FEM; CLASS II)
'hand (augmentative)'

In (131), the noun *lúž-a* 'puddle' is in class II. When the size suffix *-ic* is added, there is no change in inflectional class. The resulting noun *lúž-ic-a* 'puddle (dim)' remains in class I.

- (131) a. *lúž-a*
puddle-N.SG (FEM; CLASS II)
'puddle'
- b. *lúž-ic-a*
puddle-EXPR-N.SG (FEM; CLASS II)
'puddle (diminutive)'

Structures for (128) and (130) are given below. In (132), the noun *č'elov'ék* 'person' is in inflectional class I. When the suffixes *-ek* and *-išč'* are attached, the inflectional class does not change. In (133), the noun *ruk-á* 'hand' is in class II. When the suffixes *-k* and *-išč'* are attached, the inflectional class also remains the same.

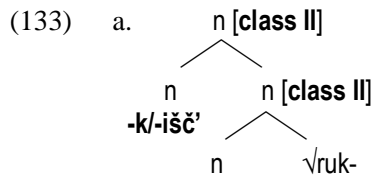
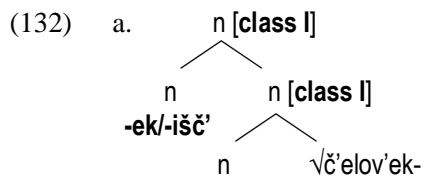

To summarize, no matter what the inflectional class of the input, there is no change in class when size suffixes are attached (Table 15).

Table 15
Size suffixes (No change in inflectional class)

EXPR _{size}	Input	Output
-k/-ek/-ok/-ik; -c/-ec/-ic; -išč'	Class I	Class I
	Class II	Class II

According to Diagnostic III (change in inflectional class), since size suffixes do not change inflectional class, they behave like syntactic modifiers (134).



5 Conclusions

I have used the following three diagnostics to determine the syntactic types of Russian expressive suffixes:

(135) *Diagnostics* (cf. Bachrach & Wagner 2007)

Diagnostic I: Do expressive suffixes change syntactic category?

Diagnostic II: Do expressive suffixes change grammatical gender?

Diagnostic III: Do expressive suffixes change inflectional class?

According to these diagnostics, expressive suffixes are syntactic heads if the answers to (135) are affirmative. Expressive suffixes are syntactic modifiers if the answers to (135) are negative. I have argued that Russian expressive suffixes belong to different syntactic types. Attitude suffixes are syntactic heads (136a), while size suffixes are syntactic modifiers (136b).

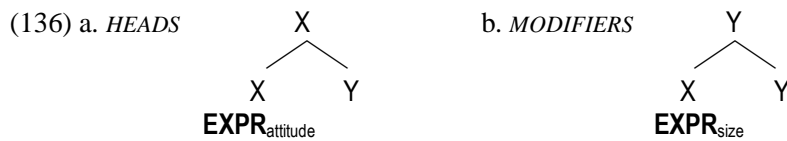

Acknowledgments

Many thanks to Martina Wiltschko for her huge help with this paper. This research was supported by a SSHRC Standard research grant (410-2006-2166), awarded to M. Wiltschko.

References

- Bachrach, A., & Wagner, M. (2007). Syntactically Driven Cyclicity vs. Output-Output Correspondence. In *U. Penn Working Papers in Linguistics* 10.1.
- Bierwisch, M. (2003). Heads, Complements, Adjuncts: Projection and Saturation. In Lang & Fabricius-Hansen (eds.), *Modifying Adjuncts*. Mouton de Gruyter.
- Corbett, G. (1980). Animacy in Russian and Other Slavonic Languages: Where Syntax and Semantics Fail to Match. In C. Chvany, & R. Brecht (Eds.), *Morphosyntax in Slavic* (pp. 43-61). Columbus: Slavica.
- Corbett, G. (1982). Gender in Russian: An Account of Gender Specification and Relationship to Declension. *Russian Linguistics*, 6(2), 197–232.
- Corbett, G. (1991). *Gender*. Cambridge: Cambridge University Press.
- Marantz, A. (1997). No Escape from Syntax: Don't Try Morphological Analysis in the Privacy of Your Own Lexicon. In *U. Penn Working Papers in Linguistics* 4.2.
- Müller, G. (2005). A Distributed Morphology Approach to Syncretism in Russian Noun Inflection, Ms. Available at: <http://www.uni-leipzig.de/~muellerg/mu52.pdf>
- Pesetsky, D. (1995). *Zero Syntax: Experiencers and Cascades*. Cambridge, MA.: MIT Press.
- Schütze, C. (1995). PP Attachment and Argumenthood. In *Papers on Language Processing and Acquisition. MITWPL Working Papers in Linguistics* 26.
- Steriopolo, O. (2008). Form and Function of Expressive Morphology: A Case Study of Russian. Ph.D. Dissertation, University of BC, Canada. Available at: <http://hdl.handle.net/2429/424>

St'át'imcets independent pronouns-the invisible cleft

Sonja Thoma

University of British Columbia
sonja.thoma@gmail.com

ABSTRACT

The main claim made in this paper is that independent pronouns in St'át'imcets have DP status across all syntactic positions. St'át'imcets, also known as Lillooet Salish, is a highly endangered First Nations language spoken in southwestern interior British Columbia. Crosslinguistically, pronouns have been analyzed as either belonging to category N or D (Postal 1966, Abney 1987). This current analysis shows that St'át'imcets independent pronouns are not NPs but DPs. Falling out from the DP analysis offered in this paper is the existence of an “invisible cleft” construction with independent pronouns in initial position.

1 Introduction

Crosslinguistically, pronouns have been categorized as either N or D pronouns (Abney 1987, Postal 1967). The categorial status of independent pronouns in St'át'imcets across all syntactic categories is unclear to date, although they have been described and documented by linguists (van Eijk 1997, Davis in prep). To my knowledge only one proposal looks at the status of independent pronouns in a principled way (Davis 2003), concluding their D status. However, the area of investigation in that research is limited to pronoun headed relative clauses.

This paper aims to establish the status of independent pronouns across all syntactic positions, but with a focus on their sentence initial occurrence, since the determination of their categorial identity is most challenging there. The independent pronouns under investigation for this research paper are additional to the bound affixal and clitic pronouns in St'át'imcets. They are called independent precisely because they are not affixes or clitics. The independent pronoun paradigm is introduced in Table 1 below. The bracketed plural marker *wi* is optional and can be dropped, especially for 1st and 2nd person. For 3rd person *wi* is only dropped with an unambiguously plural referent.

Table 1

St'át'imcets independent pronouns (adapted from van Eijk (1997) and Davis (in prep))

	Singular	Plural
1. Person	s7éntsá	(wi)snímulh
2. Person	snúwa	(wi)snuláp
3. Person	snilh	(wi)snilh

Independent pronouns can be expressed overtly as arguments. All arguments in St'át'imcets, as in all Salish languages, are obligatorily marked on the verb as agreement, so additional, overt arguments are not necessary to form a full sentence. Just a predicate and its pronominal agreement morphology can stand by itself as a grammatical sentence, as illustrated in (1).

- (1) qwatsátslhkan
 leave-1SG
 'I am leaving'

Like its other Salish sister languages, St'át'imcets is strictly predicate initial, with members of nearly all lexical categories being able to serve as predicate (2-4). The clitic *t'u7* in (2) is grouped with the predicate, since it encliticizes to it and forms a stress domain with it.

- (2) [záwem t'u7]_{PRED} i ts'úqwaz'a]_{ARGUMENT}¹
 fish.with.dipnet-MID so DET.PL fish-EXIS
 'He catches fish.' (with a dipnet)

- (3) [xzum]_{PRED} [i ts'úqwaz'a]_{ARGUMENT}
 big DET.PL fish-EXIS
 'The fish are big'

- (4) [kúkwi7]_{PRED} [ti zácal'qwem'a]_{ARGUMENT}
 Chief DET tall-appear-EXIS
 'The chief is tall' (lit. The tall one is a chief)

The data in (2-4) also show that the argument is obligatorily introduced by a determiner, whereas the predicate never has a determiner.

The remainder of the paper is organized as follows; the next section shows the problem of determining the status of independent pronouns, since they seem to occur in both NP and DP positions. It is also shown there that they never have a determiner in positions where nominals obligatorily take one. Section 3 proposes that independent pronouns are DPs in all the positions introduced in section 2. In section 4 detailed evidence is presented in support of the DP hypothesis for independent pronouns across all syntactic positions. Finally, section 5 shows a problem the current DP analysis poses and offers a solution.

¹ Unless otherwise noted, all data come from my own fieldwork.

2 Phenomenon

It can be observed that independent pronouns appear in typical DP positions; (5) shows a pronoun in the same position as the nominal in (3). For nominals it is rather uncontroversial to call this an argument position, it is not clear, however, if independent pronouns in that position are true arguments or realized as adjuncts².

(6) shows a pronoun as the cleftee of a cleft introduced with *nilh*. The cleftee, if a nominal, obligatorily occurs with a determiner (6b), i.e. it is a DP.

- (5) a. tsúnem **wisnímulh** kwas mik'iláw'scen
 say-TR-1PL.ERG **we** DET-IMPF-3POSS fried.bread
 'WE call it mik'ilaw'scen'
- b. tsútwit **i** **ucwalmícwa** kwas mik'iláw'scen
 say-3PL DET **Indian person-EXIS** DET-IMPF-3POSS fried.bread
 'The Indian people call it mik'ilaw'scen'.
- (6) a. nilh **snúwa** ti nuk'w7anána
 nilh **you** DET help-DIR-1SG.ERG-DET
 'It is YOU who I helped.'
- b. nilh **ti pu7y'ácwa** ti t'ák-a káti7
 nilh DET mouse-EXIS DET go.along-EXIS DEIC
 'A mouse went along.' (Lit: It is the mouse who went along)

Table 2 summarizes this distribution as shown in the examples above. Note that the labels on the brackets throughout this paper are not intended as category labels, but are used for expository purposes.

Table 2

Independent pronouns have the same distribution as DP nominals

a. predicate [pronoun] _{ARGUMENT}	b. predicate [DP] _{ARGUMENT}
b. nilh [pronoun] _{CLEFTEE} clausal residue	b. nilh [DP] _{CLEFTEE} clausal residue

However, independent pronouns also frequently appear in initial position (7a), a typical NP position for nominals (7b). Observe that the predicate cannot have a determiner (7c).

² Note that the independent pronouns are doubling the pronominal affixes on the verb. In this paper I am calling this an argument position. It has been argued (e.g. Jelinek & Demers 1994) that at least for Strait Salish, the verbal affixes/clitics themselves are arguments, and overt pronominal arguments are adjoined. Thus a pronominal argument hypothesis (PAH) raises the question if independent pronouns are really arguments or adjuncts.

- (7) a. **snilh** ti ats'xentáliha kw sJohn
 s/he DET see-TR-TOP-EXIS DET NOMJohn
 'SHE saw John' (Lit: the one who saw John is she)
- b. **pú7y'acw** ti t'ák-a káti7
 mouse DET go.along-EXIS DEIC
 A mouse went along. (Lit: the one going along is a mouse)
- c. ti pú7y'acwa ti t'ák-a káti7
 DET mouse-EXIS DET go.along-EXIS DEIC
 *'The mouse is going along'

The determiner on (7c) is ungrammatical under the assumption that *pú7y'acw* is the predicate. It is a well established fact for the Salish language family that predicates never can occur with a determiner. Note that (9c) is grammatical as a relative clause, meaning 'the mouse that went along'. Table 3 summarizes.

Table 3

Independent pronouns and predicate nominals

a.	[pronoun]	argument	b.	[NP]PREDICATE	argument (NPC) ³
			c.	*[DP]PREDICATE	argument

In sum, independent pronouns appear in the same positions as predicate and argument nominals, however, obligatorily without a determiner (8-9).

- (8) [qwatsátslhkan]_{PREDICATE} [s7ents]_{ARGUMENT}⁴
 leave-1SG I
 'I am leaving'
- (9) snúwa [ti qwatsátsa]_{ARGUMENT}
 you DET leave-EXIS
 'You are leaving'

Since independent pronouns seem to appear in both NP and DP positions, unmodified and determinerless, their categorial status cannot be readily determined due to the asymmetries in their distribution pointed out above.

³ NPC is short for nominal predicate construction (Davis, Matthewson and Shank 2004). In Salish, words from nearly all classes can be predicates, a phenomenon which led to the claim that Salish does not distinguish between nouns and verbs. In NPCs, as the name suggests, a noun is the predicate.

⁴ See fn. 2. Since I assume that it does not matter to my analysis if a full scale PAH (Jelinek & Demers 1994) is adopted or not, I will continue to refer to independent pronouns as occupying argument positions in these cases, mainly for ease of exposition.

3 Proposal

In this paper I claim that independent pronouns are always DPs, even where they seem to have the same distribution as NPs. The parallel observed in the previous section between nominal predicates and independent pronouns in initial position is superficial; a seemingly predicative independent pronouns is always in a cleft construction, which requires a DP argument, as shown in (9b). Since no DPs can be predicative in the language, I claim that independent pronouns in predicate position correspond to clefted DPs in the cleft construction. The contrastive focus semantics of the cleft construction and the use of independent pronouns in contrastive environments provide evidence that semantically independent pronouns and *niłh*+DP behave alike (see 4.3); this leads to the claim that the cleft particle *niłh* is optionally spelled out, but always syntactically active, supporting the DP pronoun. As further syntactic evidence, coordination tests also show that independent pronouns in initial position behave like DPs, not like NPs.

One objection that could be raised against the ‘hidden cleft’ analysis presented here is an asymmetry in what can follow an NPC and a cleft. I will call, for expository purposes, the string that follows both these constructions ‘the residue’. Clefts allow for the residue to be optionally introduced by a determiner, whereas NPCs obligatorily need a determiner on the residue. Independent pronouns seem to follow this pattern, too, suggesting that a sentence initial pronoun *is* parallel to a NPC. Section 5. spells out this problem in more detail. There I will also propose a solution for this asymmetry, which allows us to maintain the DP analysis for independent pronouns across all syntactic positions. The following section lays out the argument for a DP analysis for St’át’imcets independent pronouns in detail.

4 Evidence

Evidence for the DP status of independent pronouns across all syntactic positions can be found in their distribution (4.1), through coordination tests (4.2.), their contrastive semantics in initial position (4.3.) and through selectional evidence (4.4).

4.1 Distribution

In this paragraph I show that independent pronouns have the same distribution as regular, non-pronominal DPs. The data in (10-13) show that independent pronouns can occupy the same syntactic positions as DPs ; it therefore follows that independent pronouns are DPs by distributional identity.

- (10) a. tsúnem **wisnímulh** kwas mik’ilaw’scen
 say-TR-1PL.ERG **we** DET-IMPF-3POSS fried.bread
 ‘WE call it mik’ilaw’scen’
- b. tsútwit **i** **ucwalmícwa** kwas mik’ilaw’scen
 say-3PL **DET Indian person** DET-IMPF-3POSS fried.bread
 ‘The Indian people call it mik’ilaw’scen’.

- (11) a. nilh **snúwa** ti nuk'w7anána
 NILH **you** DET help-DIR-1SG.ERG-EXIS
 'I helped YOU (Lit: 'It is YOU who I helped. ')
- b. nilh **ti pú7y'acwa** ti t'áka káti7
 NILH DET mouse-EXIS DET go.along-EXIS DEIC
 'A MOUSE went along.' (Lit: It is the mouse who went along)
- (12) a. cw7aoz kwas nlig'wts l **wi snuláp**
 NEG that.there-open PREP-**you**
 'It is not allowed to YOU FOLKS' (van Eijk:1997:164)
- b. Nilh lhláti7 nst'k'íw'lec **lti k'é't'ha**
 NILH DEIC LOC-NOM-climb PREP-DET rock-EXIS (Matthewson 2005:155)
 'then I climbed onto the rock'
- (13) a. [**snúwa** wa7 it'em]
 you IMPF sing
 'you who are singing'
- b. [**ti sqaycwa** wa7 k'wezúsem]
 DET man-EXIS IMPF work-MID
 'the man who is working'

(4) and (5) are repeated as (10) and (11), and respectively show independent pronouns in argument position⁵ and as the cleftee of an introduced cleft. (12) has an independent pronoun as the object of a preposition, whereas in (13) it is heading a relative clause. As the (b) examples show, nominals in argument or argument related positions are always introduced by a determiner, which means they are DPs. Since independent pronouns can occur in the same syntactic positions, it follows from distributional identity that independent pronouns are DPs in these positions, albeit without an overt determiner.

4.2 Coordination

The problem of independent pronouns in initial position, as introduced in section 2, is illuminated by applying coordination tests; these tests show that independent pronouns in this typical NP position are actually DPs.

Davis (2000) established that coordination tests are valid constituency diagnostics for St'át'imcets. The general rationale behind coordination tests is that a given constituent minimally must be able to combine with another constituent of its kind; X not *only* combines

⁵ Note that the independent pronoun is doubling the pronominal affixes on the verb. I am calling this an argument position. It has been argued (e.g. Jelinek & Demers 1994) that at least for Strait Salish, the verbal affixes themselves are arguments, and overt pronominal arguments are adjoined. Thus a pronominal argument hypothesis (PAH) raises the question if independent pronouns are really arguments or adjuncts. Since I assume that it does not matter to my analysis if a full scale PAH is adopted or not, I will refer to independent pronouns as occupying argument positions in these cases, mainly for ease of exposition.

with another category *X*, but it *minimally* has to. (14) shows that an independent pronoun does not coordinate with a (determinerless) NP nominal. (15) however illustrates that coordination with a DP nominal is possible.

- (14) *snúwa muta7 kúkwi7 i zácal'qwem'a
 you AND chief DETPL tall-appear-EXIS
- (15) snúwa muta7 ti kúkwi7a i zácal'qwem''a
 you AND DET chief-EXIS DETPL tall-appear-EXIS
 'You and the chief are tall.'

Since independent pronouns in initial position do not combine with NPs, they cannot be NPs. Since they nevertheless do coordinate with DPs, I conclude that independent pronouns must be DPs in this position.

I also assume that the construction in (15) is underlyingly a cleft. Remember that a sentence initial DP in St'át'imcets is only grammatical in a cleft (16). Clefts are formed with the particle *nilh* and a DP cleftee following it.

- (16) nilh ti kúkwi7a ti zácal'qwem''a
 NILH DET chief-EXIS DET tall-appear-EXIS
 'The chief is tall' (Lit: it's the chief who is tall)

Although a rare occurrence with full NP nominals, the cleft particle *nilh* can be dropped. A transitive sentence (17) with subordinate morphology on the verb shows that the construction is indeed a cleft construction with *nilh* dropped.

- (17) ti syáqts7a muta7 ti sqáycwa wa7 áts'xenan
 DET woman-EXIS and DET man-EXIS IMPF see-TR-1SUBJ.ERG
 lti píktsha
 PREP.DET picture-EXIS
 'I see a WOMAN and a MAN in the picture'
 (Lit: the ones I see in the picture are a woman and a man)

I extend this to independent pronouns, and claim that due to their emphatic nature⁶, the particle *nilh* seems to be dropped freely with them.

In this section I showed that since pronouns in sentence initial position don't coordinate with NPs, they cannot be NPs themselves. Deciding between NP or DP pronouns (Abney 1987, Postal 1967), this leaves as the only option the claim that St'át'imcets independent pronouns are DPs⁷. Since the only way an initial DP can occur in the language is in a cleft

⁶ If a language has an extra set of pronouns, this set usually has emphatic use (Eckhardt 2001). St'át'imcets independent pronouns thus can be claimed to be emphatic. I assume that due to that the particle *nilh*, is frequently dropped, since *nilh* itself, introducing focus, is associated with emphasis.

⁷ Proposals exist that further split up DP, such as Déchaine & Wiltschko (2002). They propose phiP, a category that neither behaves like NP nor like DP. See the conclusion for further remarks.

constructions, it follows that initial independent pronouns in St'át'imcets are DPs in an underlying cleft.

4.3 *Semantics*

Further evidence for the DP status, as well for the 'hidden cleft' analysis can also be found with uncoordinated pronouns in initial position.

4.3.1 Minimal pairs with identical interpretation

It is possible to get minimal pairs with a pronounced and unpronounced *nilh*, to which the consultant gives identical translations (18). I take this judgment by the consultant as evidence that the structures are identical syntactically, and differ only in whether *nilh* is pronounced or not.

- (18) (nilh) snúwa ti wa7 ít'em
 (NILH) you DET IMPF sing
 'YOU are singing' / 'It's you who is singing'

The consultant offers both forms and both translations on different occasions. This task was repeated over the course of several weeks, and both forms were consistently treated as identical.

4.3.2 Independent pronouns and contrastiveness

Further supporting evidence for their DP status and the underlying cleft analysis proposed in section 4.2. comes from the contrastive environment in which independent pronouns are used. In order for this argument to become clear, some background information on focusing is required, following immediately below.

For this account, I adopt the theory of focus in Rooth (1996) in which focus divides discourse into a focused portion and an open proposition; focus then selects a value for the variable in the open proposition from a set of contextually salient alternative propositions. As a consequence of this definition, focus for Rooth it is contrastive but not necessarily exhaustive. Exhaustivity means that out of a set of contextually salient individuals, all the individuals are picked out. In English the kind of focus conveyed in clefts is exhaustive (19), whereas intonational focus (indicated by CAPS) on a noun is contrastive but not necessarily exhaustive (20).

- (19) It's John who came. ??? And Martin came, too.
 (20) I am really afraid of GHOSTS! And of ogres, too.

According to Percus (1997), exhaustivity readings in English clefts, causing the oddness of the remark in (19), is due to an existence presupposition caused by an underlying definite description. (21) shows the mechanism Percus proposes.

- (21) a. It is [John]_F that Mary saw.
 b. [_{IP} [_{DP} the 0 [_{CP} Op_i that Mary saw t_i]]_j [_{VP} t_j is John]]
 c. [[_{IP} [_{DP} the 0 t_k]_j [_{VP} t_j is John]] [_{CP} Op_i that Mary saw t_i]_k]
 Extraposition
 d. Definite description: [DP the 0 t_k] → **it** (=spell out) (Percus 1997:338)

The ‘*it*’ introducing clefts in English is the definite description, forcing exhaustivity through picking out the unique individual X (i.e. the clefted) of whom the proposition is true. Furthermore English clefts have an existential presupposition. (22) how this works with respect to the example in (21).

- (22) → *existential presupposition*: Mary saw someone
 → *assertion*: The someone Mary saw is John
 → *uniqueness/exhaustivity presupposition*: Mary didn’t see anybody else

St’át’imcets clefts are different from English clefts in that they lack exhaustivity presupposition. Example (23) shows that a cleft can be used with *also*.

- (23) nilh sLisa **t’it** ti ats’xenána láku7 tsítwa
 NILH NOMLisa **also** DET see-TR-1SGEG-EXIS DEIC house
 ?It’s also Lisa who I saw in the house

Clefts in this language also lack existential presupposition, which means that they can be used in out of the blue contexts (24) (Davis, Matthewson, Shank 2004)⁸.

- (24) ni spála7sa **nilh ti plísmena** t’íq áts’xentsas
 DET NOM-one-3.SPOSS-EXIS NILH DET policeman-EXIS arrive see-DIR-1SOBJ-3ERG
 ‘Once a policeman came to see me’ (DMS 2004:113)

DMS 2004 note that St’át’imcets NPCs are also used to convey focus, and they share the same characteristics as clefts; they also lack exhaustivity (25) and existential presuppositions (26).

- (25) syáqtsa7 **t’it** ti áts’xenána
 woman **also** DET see-TR-1SGEG-EXIS
 ‘I also saw a woman’

Q; Who do you see in this picture?

- (26) syáqtsa7 muta7 sqaycwa7 (ti) wa7 áts’xenan lti píktsha
 woman AND man (DET) IMPF see-TR-1SGERG PREP-DET picture-EXIS

⁸ This is, as pointed out by DMS, due to the differing semantics of the determiners in St’át’imcets (Matthewson 1998) and English.

'I see a woman and a man in the picture'

Note the relevance of this, since the basic question in this paper is if independent pronouns in initial position are NP (and hence NPCs) or DPs (and hence in a cleft).

A phenomenon not mentioned by DMS (2004) is that NPCs and clefts differ semantically in one regard; clefts may be used to convey contrastive focus, while nominal predicates may not. The data in (27) and (28) illustrate this.

Context: two pictures, one with a sleeping dog, another with a bear climbing a tree.

Q: swat ku guy'tál'men (who is sleepy)

- (27) nilh ti sqáx7a (ti) wa7 guy't
 NILH DET dog-EXIS (DET) IMPF sleep
 'The DOG is sleeping' (Lit: It's the dog who is sleeping)

The consultant prefers the answer (28) over (29) as more appropriate to the question asked. This shows that only clefts, but not NPCs are used in contrastive environments.

- (28) sqáxa7 (ti) wa7 guy't
 dog (ti) impf sleep
 'A dog is sleeping' (Lit: the sleeping one is a dog)

Bringing back the discussion to independent pronouns, yet bearing in mind the contrastive use of clefts, the data below shows that independent pronouns are used in contrastive situations without using *nilh* (29,30).

Context: Bill tells everyone he shot a bear. That's not true, I shot it and I tell my friend:

- (29) s7énts ti zuqwnucwstáliha ti míxalha
 I DET kill-animal-TR-TOP.EXIS DET bear
 cw7aoz kw snilhts sBill
 NEG DET NOM-NILH-3RDPOSS NOMBill
 'I killed the bear, not Bill!'

Context: Sue is in love with Peter, but Paul thinks Mary likes Peter. Sue says to her friend:

- (30) s7énts ti amasána kw sPeter, cw7aoz
 I DET good-TR- 1SG.ERG DET NOMPeter NEG
 kw snilhts sMary
 DET NOM-NILH-3POSS NOMMary
 'I like Peter, not Mary!'

It would also be expected that independent pronouns appear with *nilh*, also in contrastive environments. This prediction is borne out (31-32).

Context: Bill and Joe are in disagreement who saw a bear first.

(31) s7ents ti kél7a ats'xentáli ti mixálha
 I DET first-EXIS see-TR-TOP DET bear-EXIS
 'I saw the bear first.'

(32) nilh s7ents!
 NILH I
 'I did!'

To sum up the results of this section, independent pronouns in initial position are used in St'át'imcets to convey contrastivity. They are used contrastively with and without *nilh*. I also showed that only clefts with a DP cleftee can express contrastivity. I thus conclude that independent pronouns are DPs in initial position. They are not really predicates, but a DP cleftee. The cleft particle *nilh* is dropped in speech sometime, but always stays syntactically active, supporting the DP pronoun.

4.4 Selectional evidence

The last piece of evidence I present to support the DP status of independent pronouns is through selectional data. St'át'imcets pronouns select for an NP complement. In most cases the NP is empty. However, the nominal can also be overt (34-36), which leads me to propose that independent pronouns, as DPs, occupy the D head. With this claim I am following Davis (2003), who proposed this for independent pronouns in pronoun headed relative clauses. (33) shows the proposed structure.

(33)

	DP	
	^	
	D	NP
	snilh	Ø
	snúwa	
	s7éntsá	

(34) **sni mulh** syeqyé'qts7a tsícwkalh q'wezílč
 we woman:REDUP-EXIS go-1PL dance
 'Us girls went dancing'

(35) **núwa qecwqícw** syéy'qtsa7 síma7 ts7a
 you wild:REDUP girl:REDUP come DEIC
 'You silly girl, come here!'

(36) **Nilh wisní mulh smelhmém'lhats** wa7 q'welaw'entáli iz'
 NILH we woman:REDUP IMPF pick.berries-TR-TOP DEM.PL
 'I was us girls who picked them' (Matthewson 2005: 455)

I showed in this section that independent pronouns are DP pronouns, occupying the D head of a structure that tends to have an empty NP complement. However the prediction is that this complement can be filled. The data presented above shows that this prediction is borne out; hence, independent pronouns are determiners, occupying D.

5 A problematic asymmetry

In this section I would like to address a potential problem for the DP analysis of independent pronouns across all syntactic categories. There is an asymmetry in pronoun clefts vs. nominal clefts. The data below lays out full nominals as predicate and in a cleft (37, 38), and independent pronouns with and without *nilh* (39, 40). The (a) examples show the residue following the nominal introduced by a determiner, whereas the (b) examples show the determiner can only be dropped for a cleft.

- (37) a. sqaycw [**ti wa7 q'wezilc**]
 man [det impf dance-aut]
 'The man is dancing'
 (Lit: the dancing one is a man)
- b. *sqaycw [**wa7 q'wezilc**]
 man [impf dance-aut]
 speaker comment: not a good sentence
- (38) a. nilh ti sqáycwa [**ti wa7 qwezilc**]
 nilh det man [det impf danceaut]
 'It's the man who is dancing.'
- b. nilh ti sqáycwa [**wa7 q'wezilc**]
 nilh det man [impf dance-aut]
 'It's the man who is dancing.'
- (39) a. snúwa [**ti wa7 ít'em**]
 you [det impf sing-mid]
 'You are singing' (lit: It's you who is singing)
- b. *snúwa [**wa7 ít'em**]
 you [impf sing-mid]
 comment: not a complete sentence (lit: 'you who is singing'=relative clause)
- (40) a. nilh snúwa [**ti wa7 ít'em**]
 nilh you [det impf sing-mid]
 It's you who is singing
- b. nilh snúwa [**wa7 ít'em**]
 nilh you [impf sing-mid]

It's you who is singing

The immediate question arising when comparing the nominal (37-38) to the independent pronoun constructions (39-40) is: Why, if an initial pronoun is always in a cleft, as claimed in this paper, does it behave differently with an overt vs. dropped *nilh*? Specifically (39) shows this, and poses a problem for the account given here; (39) a and b should behave identically, i.e. just as (40), if the 'invisible cleft' analysis offered in this paper is correct. The table below summarizes the problem, and shows that independent pronouns without the particle *nilh* seem to behave parallel to NPCs, both being unable to drop the determiner on the residue.

Table 4

Asymmetry in independent pronoun residue with and without *nilh*

	determiner precedes residue	no determiner precedes residue
NPC	Y	*
Nominal cleft initial pronoun	Y	Y
(=Pronominal cleft w/ invisible <i>nilh</i>)	Y	*
Pronominal cleft	Y	Y

I propose the following solution to this problem: I assume that St'át'imcets speaker avoid the possibility of garden-path processing of the sentence type in (39b). I assume hence that the determiner on the residue serves to disambiguate between a full sentence and a pronoun headed relative clause. A similar strategy is employed in English, where, presumably for the exact same reasons, it is ungrammatical to drop the complementizer in sentences such as "the man *(that) saw me"⁹.

Thus the seeming asymmetry is explained by disambiguation. If *nilh* is present, the sentence cannot be mistaken for a relative clause, and the determiner can be dropped. If *nilh* is unpronounced, the possibility exists for mistaking the utterance for a relative clause, for which reason the determiner stays on. I leave it up to future research to explore this asymmetry in more detail.

6 Conclusion

In this paper I showed that independent pronouns across all syntactic positions are DPs due to their distribution. They are also DPs in initial position, which was shown through coordination and their use in contrastive environments; contrastiveness in St'át'imcets is expressed through clefts alone, not by NPCs. Hence seemingly "bare" independent pronouns are used in initial position in contrastive environments, which means that they cannot be NPs, (i.e. the equivalent of a NPC). Instead independent pronouns in initial position correspond to the clefted DPs in clefts. As a consequence for "bare" initial pronouns this means that the

⁹ Thanks to Henry Davis and Hotze Rullmann for pointing this out. Note that some determiners in St'át'imcets can serve as complementizers.

cleft is there, yet the particle *nilh* is dropped. Selectional evidence further established that independent pronouns are D.

Further investigations of St'átimcets independent pronouns will have to include a closer examination of the cleft construction, and more specifically the cleft particle *nilh*. Also the asymmetry in the possible residues following cleft vs. nominal predicates, presented in section 5, raises questions about the syntax of the cleft construction and warrants further investigation.

Finally, accounts exist that hold an analysis of pronouns doesn't necessarily have to revolve around the two categories, D vs. N; ever since the DP hypothesis for pronouns (Abney 1987), DP has been split up into further functional categories. In the spirit of analyses that favor functional projections contained in DP, several proposals have been made as to what categories are contained under D. One such approach that proposes intermediate functional projections is Déchaine & Wiltschko (2002). They propose phiP, a projection that neither behaves like NPs nor like DPs, and can serve both as argument and as predicate. The imminent question arising is if St'átimcets independent pronouns can be accounted for with a phiP analysis. Future research will have to establish this.

Acknowledgments

I'd like to thank Laura Thevarge for her patience and good humor in teaching her language. I also owe many thanks to my committee (Hotze Rullmann, Henry Davis and Martina Wiltschko) and to Lisa Matthewson.

References

- Abney, S. 1987. The English Noun Phrase in Its Sentential Aspect, unpublished Ph.D. dissertation, MIT
- Davis, H. 2000. Coordination and Constituency in St'at'imcets. in Gessner, S. & S. Oh (eds.) UBCWPL Vol. 3:40-77.
- Davis, H. 2003. Some crazy relatives in St'át'imcets (Lillooet Salish), Presented at the University of Washington, March 7.
- Davis, H. In prep. A Teacher's Grammar of Upper St'át'imcets.
- Davis, H., L. Matthewson, & S. Shank. 2004. Clefts vs nominal predicates in two Salish languages. In: D. Gerds et al. (eds.) Studies in Salish Linguistics in Honor of M. Dale Kinkade, eds., University of Montana Press.
- Déchaine, Rose-Marie, and Wiltschko, Martina. 2002b. Decomposing Pronouns. Linguistic Inquiry 33:409-442.
- Eckhardt, Regine. 2001. Reanalyzing selbst. Natural Language Semantics 9,4. 371- 412.

- Jelinek, E. & R.A. Demers .1994. Predicates and pronominal arguments in Straits Salish. *Language* 70, 697 – 736.
- Matthewson L. 2005. *When I Was Small – I Wan Kwikws. A Grammatical Analysis of St'át'imc Oral Narratives*. UBC Press. Vancouver.
- Percus, O. 1997. Prying open the cleft. *NELS* 27, 337-351.
- Postal, P. 1966. 'On So-called Pronouns in English', in D. Reibel and S. Schane (eds.), *Modern Studies in English*, Prentice-Hall, Englewood Cliffs, New Jersey, 201–223.
- Rooth, M. 1996. Focus. In: Lappin, S. (ed.) *Handbook of Contemporary Semantic Theory*. Oxford: Blackwell, 271-297.
- van Eijk, J. 1997. *The Lillooet Language. Phonology, Morphology, Syntax*. Vancouver: UBC Press.

A Radical Construction Grammar analysis of Mandarin Chinese SOV sentences

Antoine Tremblay

University of Alberta

antoinet@ualberta.ca, www.ualberta.ca/~antoinet

ABSTRACT

This paper discusses, from a Radical Construction Grammar perspective (Croft 2001), simple Mandarin Chinese SOV sentences, using terminology developed by Mel'čuk (2001) to account for the Semantic-Communicative Structure of sentences. It is argued here, contrary to what is traditionally thought, that there are three SOV constructions instead of one, namely: (i) bare SOV constructions, (ii) SOV-*le* constructions, and (iii) SOV-*guo* constructions, all of which encode Foregrounded Direct Objects. Of the three, only the bare SOV construction is inherently contrastive, and only the SOV-*le* construction encodes Foregrounded Verbs as well as Foregrounded Direct Objects. In addition, it is shown that the three SOV constructions are different from SVO and OSV constructions in that the Subject or the Direct Object can be a Rhematic Focus in the two latter constructions (i.e., they can be the unknown element in a question-answer sequence), but not in the latter one. The fact that the meaning associated with these SOV sentences is non-decomposable, in other words, that it is contingent on the whole sentence and not on any specific component of the sentence, suggests that these grammatical structures are represented in the mind of a speaker.

Keywords: Radical Construction Grammar; Meaning Text Theory; Mandarin Chinese; Subject-Object-Verb; SOV; Semantic-Communicative Structure; Information Structure; Foregrounded; Contrastive.

1 Introduction

Using the Radical Construction Grammar framework (RCG; Croft 2001) and terminology developed by Mel'čuk (2001) to account for the communicative/informational considerations encoded by sentences, the present paper shows that there are three distinct SOV constructions in Mandarin Chinese (MC). The three SOV constructions are (i) bare SOV sentences, which encode Foregrounded and contrastive Direct Objects, (ii) SOV-*le* sentences, which encode Foregrounded Direct Objects and Verbs, and (iii) SOV-*guo* sentences, which encode Foregrounded Direct Objects.

The data used in this study comes from elicitation and the literature (Li 1990; Shyu 2001, 2004; Sun and Givón 1985; Wei 1989; and Zhang 2000 among others). Before saying more, two points need to be mentioned. Firstly, the present paper merely discusses mono-clausal

sentences without coverbs or adverbial phrases.¹ Secondly, it is sometimes said that SOV sentences are S-*ba*³-OV constructions where the coverb *ba*³ has been elided. In this study, I follow Li (1990) who convincingly argues this view is incorrect and that SOV sentences are a topic of discussion in their own right.² Having said this, let us turn to describing the concepts and notions that will be used here.

2 Notions and Concepts

In this section, notions and concepts relevant to the study are delineated. In section 2.1, the Radical Construction Grammar framework is characterized. In section 2.2, a brief overview of the Meaning-Text Theory (Žolkovskij & Mel'čuk 1967; Mel'čuk 1988, 2001) and relevant aspects of Mel'čuk's (2001) theory of communicative/informational considerations are presented.

2.1 Radical Construction Grammar

RCG, as laid out in Croft (2001), is a non-reductionist theory of grammar that assumes a Conceptual Structure populated by largely universal concepts. The Conceptual Structure underlies the Semantic Structure, which is comprised of language-specific construals of concepts. The Semantic Structure is arbitrarily linked to the Syntactic Structure by a Symbolic Relation. Grammar is thus “a structured inventory of conventional linguistic units” (Langacker 1987: 57); where the term ‘linguistic unit’ is understood here as construction. A construction, the basic unit in RCG, could be thought of as a schematic idiom (Croft 2001: 15). That is, it is a more or less complex linguistic sign composed of a more or less complex Syntactic pole, arbitrarily linked to a more or less complex Semantic pole. The construction has a meronomic relation with its constituents, that is, a part-whole relation between it and the elements that populate it. Symbolic Relations not only link a construction's Syntactic and Semantic poles as a whole, but also the form and meaning of its individual elements. This is illustrated in Figure 1, adapted from Croft (2001: 21).

¹ Coverbs are defined in Po-Ching & Rimmington (2004) as verbs that are similar to English prepositions and that generally occur in conjunction with other verbs (e.g., *dui*⁴ ‘towards, facing’, *xiang*⁴ ‘heading, towards’, and *zi*⁴ ‘from’). Some coverbs, however, may also function as independent verbs. Consider for instance *zai*⁴: In *ta*¹ *zai*⁴ *jia*¹ *xiu*¹ *xi* ‘he’s resting at home’ *zai*⁴ is used as a preposition, but in *ta*¹ *bu*⁴ *zai*⁴ *jia*¹ ‘he’s not at home’ it is a verb. It is probable that the *zai*⁴ used as a preposition and *zai*⁴ used as a verb are two different lexemes.

² For specific details about the differences between these two constructions, see Li Shen (1990: Chapter 5).

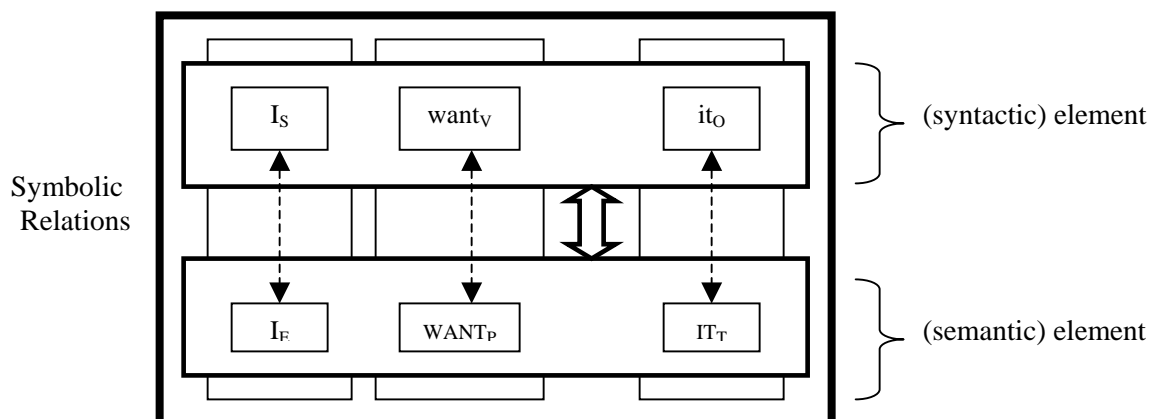

Figure 1
The transitive SVO construction in English.

The sentence *I want it* shown in Figure 1, is an instantiation of the very schematic transitive construction SVO. This construction is characterized by a Subject-Verb-Object Syntactic Structure and an Experiencer-Predicate-Theme Semantic Structure, which are linked through a Symbolic Relation (indicated by the solid arrow).³ In addition, the SVO construction encompasses other smaller constructions, namely *I*, which in this case takes on the role of the Subject-Experiencer, *want*, which is the Verb-Predicate here, and *it*, the Object-Theme of the sentence. Other examples of English constructions are the *way* construction (Israel 1996; e.g., *Mary coffeed her way out of university*), the passive construction (Rice 1987, 1993; e.g., *Sally was argued with by Bill*), and the *let alone* construction (Fillmore et al. 1988; e.g., *I don't have a penny, let alone a dollar*).

2.2 *Semantic-Communicative oppositions*

The Semantic Structure, or 'meaning', of a construction includes "all of the conventionalized aspects of a construction's function, which may include not only properties of the situation described by the utterance but also properties of the discourse in which the utterance is found ... [as well as] the pragmatic situation of the interlocutor" (2001: 19). The RCG framework as described in Croft (2001) only briefly discusses this aspect of grammar, the focus of the book being Syntax. In this paper, the term 'meaning', more specifically that part of it called 'information structure' by Lambrecht (1994) or 'semantic-communicative structure' by Mel'čuk (2001), will be elaborated on. Given that Mel'čuk's theory of communicative/information structure is used here, relevant aspects of it are briefly discussed.

Before defining the Semantic-Communicative-oppositions of Focalization and Perspective, let us have a succinct look at the framework from which they are borrowed.⁴ The Semantic-Communicative Structure divides the Semantic Structure into eight areas, or

³ Note that the terms Subject, Verb, Object, Experiencer, Predicate, Theme, and others of the sort used in this paper are merely labels utilized to facilitate the discussion, whose definitions are constructionally- as well as language-specifically defined (Croft 2001: 170).

⁴ See Žolkovskij & Mel'čuk (1967) and Mel'čuk (1988, 2001) for an in-depth characterization of the Meaning-Text framework.

Semantic-Communicative-oppositions, namely (i) Thematicity (i.e., also known as the Topic-Comment dichotomy); (ii) Givenness; (iii) Focalization; (iv) Perspective; (v) Emphasis; (vi) Presupposedness; (vii) Unitariness; and (viii) Locutionality. Of these eight, one is relevant to the present discussion and will be described shortly. The Semantic-Communicative Structure superimposes on the Semantic Structure to form (a partial) Semantic Representation, an example of which is given in Figure 2.

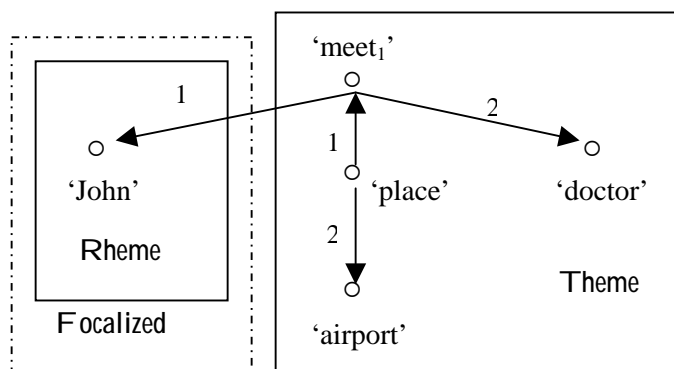
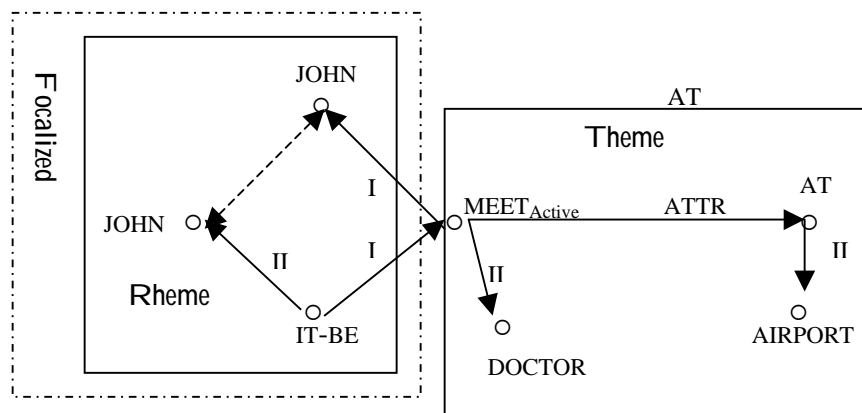

Figure 2
A partial Semantic Representation.

In Figure 2, the numbers labelling the arcs differentiate the different arguments of a functor (e.g., a verb, a preposition, etc.). That is, 'John' is the 1st argument of the functor 'meet₁' and 'doctor' is its 2nd argument, whereas 'meet₁' is the 1st argument of the functor 'place' and 'airport' is its 2nd argument. In addition, this representation shows that 'John' is the Rheme of the Semantic Structure (what is said about the meeting event), while 'meet₁', 'place', 'airport', and 'doctor' are part of the Theme (what the message is about). In addition, 'John' is Focalized.⁵

The Semantic Representation determines the Deep-Syntactic Representation of a sentence, which in turn determines its surface phonological form. The partial Deep-Syntactic Representation corresponding to the Semantic Representation shown in Figure 2 is given in Figure 3 below (adapted from Mel'čuk 2001: 9).

⁵ Roughly, a Focalized element is the part of a proposition which the Speaker presents as being logically prominent for him, that is, which is in the speaker's focus of attention. Consider the following dialogue, where *John* in B's utterance is Focalized: A: *I think Mike met the doctor at the airport.* B: *It was John who met the doctor at the airport.*

**Figure 3**

A partial Deep-Syntactic Representation of Figure 2.

The arrows going from one node to another indicate Deep-Syntactic Relations (DSyntRels) such as the actantial DSyntRels I, II, the ATTR(ibutive) DSyntRel, and the COORDINATE DSyntRel. The dashed bi-directional arrow shows obligatory co-reference between the two occurrences of the lexeme JOHN. In Figure 3, it is shown that (i) MEET_{Active} has a DSyntRel I relation to IT-BE, (ii) JOHN has a DSyntRel II relation to IT-BE as well as a DSyntRel I relation to MEET_{Active}, (iii) DOCTOR has a DSyntRel II relation to MEET_{Active}, (iv) AT → AIRPORT has an Attributive relation to MEET_{Active}, and (v) AIRPORT has a DSyntRel II relation to AT. In addition, the superimposed Deep-Syntactic-Communicative Structure (indicated by the boxes) shows that (vi) JOHN is the Rheme, (vii) MEET_{active}, DOCTOR, AT, and AIRPORT are part of the Theme, and (viii) JOHN is Focalized.⁶ This particular Deep-Syntactic Representation would give rise to B's reply in (1).

- (1) [A and B are talking about the doctor, who arrived at the airport yesterday.]

A: I think Mike met the doctor at the airport.

B: It was John who met the doctor at the airport.

In RCG terms, Mel'čuk's theory of Semantic-Communicative Structure reduces to the following: A Semantic-Communicative-opposition is simply part of the Semantic Structure of the element which has that specific Semantic-Communicative-opposition. By way of example, consider the B sentence in (1). This sentence instantiates what is called the Cleft *it BE S who VO*, which is schematized in Figure 4 (the dashed line linking 'x₀' and 'who_s' in the syntactic structure of the construction indicated that these two elements are co-referential; FOC stands for Focalized).

⁶ The Deep-Syntactic-Communicative Structure specifies the division of the sentence into Theme-Rheme, Given-New, etc. Part of what constitutes the Semantic-Communicative Structure is encoded, at this level, in the lexical choices made: for instance, adjectives and other types of modifiers vs. finite verbs, as well as the choice of corresponding articles etc. (Mel'čuk 1988: 66).

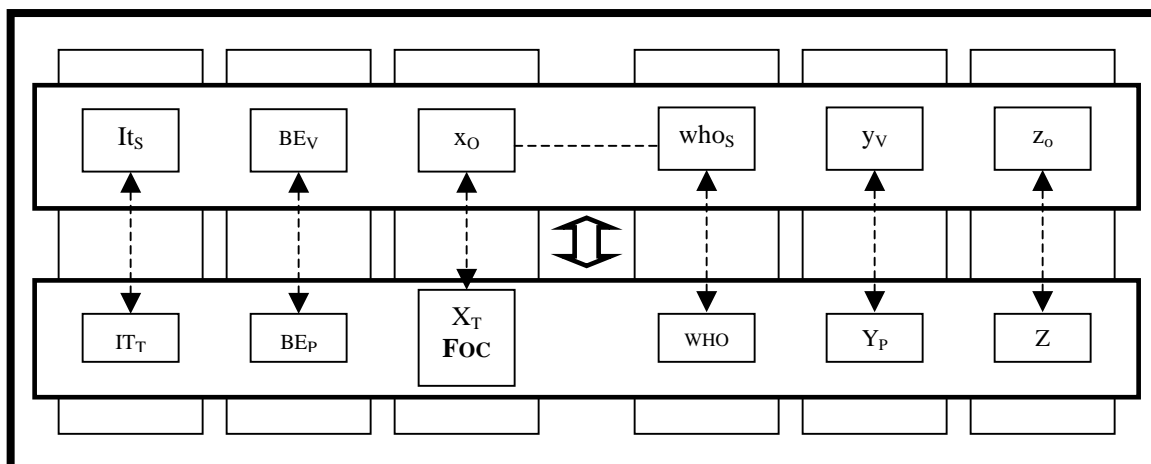

Figure 4
The Cleft *it BE S who VO* construction.

Notice that in Figure 4, the meaning of the element ‘ x_0 ’ of the Syntactic Structure is partly pre-specified. Indeed, irrespective of the meaning of the word that would fill this position (indicated by ‘ X_T ’ in the Semantic Structure), the meaning of ‘Focalized’ (appearing in bold) is inherently present. In other words, the whole construction encodes a Focalized Subject. In the following sections, the Semantic-Communicative-opposition of Perspective is characterized.

2.3 Perspective

Perspective has the values Foregrounded, Backgrounded, and Neutral. Foregrounded and Backgrounded can be characterized as the part of a Semantic Structure which the speaker presents as psychologically prominent/secondary for him – that is, as having, from his point of view, special/reduced psychological importance with respect to what he wants to communicate (Mel’čuk 2001: 199). To be psychologically prominent is to be central, in the opinion of the speaker, to the situation described, whereas to be psychologically secondary is to be peripheral to it. Neutral amounts to being Neither-Foregrounded-nor-Backgrounded. To exemplify Backgrounding, consider the following sentence.

- (2) [John]_{Neutral}, [who is a very good carpenter]_{Backgrounded}, [built this cabinet]_{Neutral}

In (2), the clause *who is a very good carpenter* is Backgrounded, that is, it is secondary in the eyes of the Speaker, while the rest of the sentence is Neutral. What is known as ‘possessor raising’ is a good example of Foregrounding. In brief, possessor raising ‘promotes’ the possessor of a noun to a higher ‘syntactic rank’ at the Deep-Syntactic Structure (Mel’čuk 2001: 204-5). Compare the following French sentences (adapted from Mel’čuk 2001: 206).

- (3) a. J'ai lavé sa tête 'I have washed his head'
 b. Je [lui]_{Foregrounded} ai lavé la tête 'I to-him have washed the head'

The non-raised construction appears in (3a). It is shown here that the possessor of *tête* 'head' is expressed via the possessive adjective *sa* 'his', which is dependent on the Direct Object *tête* 'head' (2nd rank dependency), which in turn is dependent on the main verb *ai lavé* 'have washed' (1st order dependency). The construction with raising is given in (3b). In this case, the possessor is expressed by the dative clitic pronoun *lui* 'him', which directly depends on the main verb; the thing washed, namely *tête* 'head' which also directly depends on the main verb, is preceded by the definite article *la* 'the'. In other words, the possessor of the head being communicatively more salient than the possessed is 'promoted' or 'raised' from a 2nd rank dependency to a 1st rank dependency (relative to the main verb).

3 Three SOV constructions in Mandarin Chinese

Many researchers say that the Direct Object in SOV sentences is focused/emphatic/contrastive (Sun & Givón 1985, Wei 1989, Li Shen 1990, Zhang 2000, and Shyu 2004 among others). This is illustrated below (COMPL stands for COMPLETIVE aspect; tones are indicated by superscripted numbers: ¹ = high tone, ² = rising tone, ³ = falling and rising tone, ⁴ = falling tone, and Ø = neutral tone):

- (4) [Lisi asked Zhangsan to wash the car before he gets back from work. During lunch break, Zhangsan calls Lisi to tell him the following.]

- | | | | | |
|----|------------------------------|----------------------------------------------------------------|---------------------------------------|-------|
| a. | wo ³ | xi ³ -hao ³ -le | che ¹ .zi | (SVO) |
| | I | wash-good-COMPL | car | |
| | 'I finished washing the car' | | | |
| | | | | |
| b. | wo ³ | [che ¹ .zi] _{Focused/emphatic/contrastive} | xi ³ -hao ³ -le | (SOV) |
| | I | car | wash-good-COMPL | |
| | 'I the car finished washing' | | | |

According to these authors, the Direct Object in (4b) is focused/emphatic/contrastive whereas the one in (4a) is not. Note that in this study, the Direct Object in (4b) is said to be Foregrounded instead of focused/emphatic/contrastive. Others, such as Li Shen (1990), maintain that the DO in (4a) occurs in post-verbal position because it is a secondary Rheme while the Verb is a secondary Theme, but in (4b) the DO appears in immediate pre-verbal position given that it is a secondary Theme while the Verb is a secondary Rheme (also see Shyu 2001).⁷ It is important to mention that what underlies the ordering of words here is not

⁷ Briefly, the Theme-Rheme opposition is the most universal and relevant of Semantic-Communicative oppositions in that a message necessarily says something (the Rheme) about something (the Theme). The Theme of a sentence can be defined as the part of its Semantic Structure which corresponds to what the message is about, and the Rheme as what is stated about the Theme by means of the sentence. Note that a Semantic Representation necessarily contains a Rheme, but it need not contain a Theme.

the Theme-Rheme opposition, but rather the Semantic-Communicative opposition of Perspective (see Tremblay and Beck, in preparation).

Traditionally, it is thought that SOV sentences comprise one monolithic category of sentences. However, it is argued here that the SOV category is rather heterogeneous. More specifically, it is claimed that there are three SOV constructions namely, (i) bare SOV sentences which encode Foregrounded Direct Objects, which is necessarily contrastive (the sentence is bare in the sense that the verb is not modified by any tense, aspect or mood particle), (ii) SOV-*le* sentences which encode Foregrounded Direct Objects and Verbs (my informants tell me that both the DO and the Verb are prominent in some way), and (iii) SOV-*guo* sentences which merely encode Foregrounded Direct Objects (contrary to the DO in bare SOV sentences, the DO in SOV-*guo* sentences is not necessarily contrastive). The idea that the Direct Object is Foregrounded stems from Wang (1994), who claims that, based on empirical evidence, the Direct Object in *ba3* constructions are Foregrounded. It is also in line with the literature as well as my informants in that the Direct Object in this structure is prominent in some way. I will start by showing that only bare SOV sentences are inherently contrastive.⁸

Some researchers have already pointed out that not all SOV sentences are contrastive. Li Shen (1990) and Shyu (2001) observe that in certain cases SOV sentences fail to show contrast or emphasis. First, let us consider the contrastive sentences in (5), where the contrastive element is underlined in the English gloss, COMPL stands for COMPLETIVE aspect and EXP for EXPERIENCE aspect.⁹

- (5) a. [Lisi and Zhangsan are trying to decide what kind of wine they will drink. Lisi names different wines. Zhangsan says that he doesn't drink them, but drinks champagne.]

wo³ [xiang¹.bin¹.jiu³]_{Foregrounded} he¹ (bare SOV)
I champagne drink
'I champagne drink'

- b. [In a game, there is a list of wines that participants need to drink. Wanting to know which kinds his team-mate drank, Zhangsan reads the list to him. Zhangsan's team-mate informs him that he did not drink any of the wines mentioned so far, but drank champagne.]

wo³ [xiang¹.bin¹.jiu³]_{Foregrounded} [he¹-le]_{Foregrounded} (SOV-*le*)
I champagne drink-COMPL
'I champagne drank'

⁸ Note that contrastiveness is part of the Rhetorical Structure (Mel'čuk 2001: 81). Briefly, the Rhetorical Structure specifies the style and rhetorical characteristics that a speaker wants his message to have.

⁹ Note that *-le* and *-guo* in (5b) and (5c) convey the meaning of completion and experience respectively. The completion aspect marker *-le* indicates that something has already taken place while the experience marker *-guo* conveys the meaning that the event has been experienced in the past. See Po-Ching & Rimmington (2004) for a more detailed account of these aspectual markers.

- c. [Lisi names different kinds of wines. Zhangsan says that he never tasted them before. Then Lisi names champagne, and Zhangsan says that he has drunk it.]

wo³ [xiang¹.bin¹.jiu³]_{Foregrounded} he¹-guo (SOV-*guo*)
 I champagne drink-EXP
 'I champagne have drunk'

All the preceding sentences have a contrastive meaning. However, only bare SOV sentences necessarily entail contrast whereas the other two types of sentence do not. Note that the contexts in which the following sentences occur impose a non-contrastive reading.

- (6) a. [Zhangsan went to see Lisi. Lisi asks Zhangsan what he wants to drink. Zhangsan answers the following.]

*wo³ [xiang¹.bin¹.jiu³]_{Foregrounded} he¹ (bare SOV)
 I champagne drink
 'I champagne drink'

- b. [Zhangsan was asked to drink a bottle of champagne. An hour later he goes to the person in charge and says the following.]

wo³ [xiang¹.bin¹.jiu³]_{Foregrounded} [he¹-le]_{Foregrounded} (SOV-*le*)
 I champagne drink-COMPL
 'I finished drinking the champagne'

- c. [Lisi is telling Zhangsan how champagne is the greatest thing he ever drank. Zhangsan says to him the following.]

wo³ [xiang¹.bin¹.jiu³]_{Foregrounded} he¹-guo (SOV-*guo*)
 I champagne drink-EXP
 'I have drunk champagne before'

The bare SOV sentence in (6a) is unacceptable because it cannot be used in a non-contrastive context; in this case an SVO sentence should be used (i.e., *wo³ he¹ xiang¹ bin¹ jiu³* 'I drink champagne'). The SOV-*le* and SOV-*guo* sentences in (6b-c), however, are perfectly fine. The point to be made here, and what is of special interest, is that bare SOV sentences distinguish themselves from SOV-*le* and SOV-*guo* sentences in terms of their inherent contrastiveness.

Another interesting point is that the three types of SOV sentences can be further distinguished with regards to the elements that are Foregrounded. Here we will see that SOV-*le* sentences encode Foregrounded DOs and Verbs, whereas the other two sentence types only encode Foregrounded DOs. The distinction can be made with the help of the marker *lian² ... dou¹* 'even', where *lian²* means 'even' and *dou¹* means 'all' (translated in English simply as *even*). This marker has been said to indicate focus/emphasis/contrast (Zhang 2000 and Shyu 2004, among others). As the examples given below show, *lian² ... dou¹* 'even' is not contrastive but rather highlights a similarity between X and a group of things of type Y.

Formally, *lian*²...*dou*¹ ‘even’ is considered to mean “X is (against expectations) also in the set of things of type Y which we are discussing” and will be said to be ‘additive’, following Zhang (2000).¹⁰ The present argumentation hinges on a remark made by Mel’čuk (2001: 183) according to which “a member of a contrastive pair is necessarily Focalized, even if a Focalized element is not necessarily a member of an explicit contrast”.¹¹ I propose to extend this idea to include Foregrounded and Emphasized elements.¹² Applying this extended notion to additiveness, an additive element is necessarily Focalized, Foregrounded or Emphasized, even if a Focalized, Foregrounded or Emphasized element is not necessarily additive. Note that *lian*²...*dou*¹ ‘even’ is not a Foregrounding marker: As evidenced by the sentences in (5) above, the Direct Object, and the Verb in the case of SOV-*le* sentences, are still Foregrounded even if *lian*²...*dou*¹ ‘even’ is not present. Having said this, let us first consider the following SOV-*le* sentences, where the additive element is double-underlined in the English gloss.

- (7) a. [In a game, there is a list of wines participants have to drink. Wanting to know which kinds his team-mate drank, Zhangsan reads him the list: the Bordeaux, the Riesling, etc. Zhangsan’s team-mate informs him that he already drank them and adds the following (the champagne is also on the list).]

wo ³	lian ²	[xiang ¹ .bin ¹ .jiu ³] _{Foregrounded}	dou ¹	[he ¹ -le] _{Foregrounded}
I	even	champagne	all	drink-COMPL
‘I even <u>the champagne</u> drank’				

- b. [Mr. and Mrs. Zhang are in a restaurant; they are having caviar and champagne as an appetizer. Mrs. Zhang wants to smoke a cigarette but there aren’t any left in her pack, so she sends her husband to the convenient store to buy some. When Mr. Zhang comes back with the pack of cigarettes he sees that his wife ate all the caviar. Mrs. Zhang then says the following with a smile on her face.]

wo ³	lian ²	[xiang ¹ .bin ¹ .jiu ³] _{Foregrounded}	dou ¹	[he ¹ -le] _{Foregrounded}
I	even	champagne	all	drink-COMPL
‘I even <u>the champagne</u> drank up’				

Because both the Direct Object and the Verb are Foregrounded in SOV-*le* sentences, either the Direct Object alone can be additive, as shown in (7a), or both the Direct Object and the Verb can be additive, as illustrated in (7b).

SOV-*le* sentences contrast with bare SOV sentences and SOV-*guo* sentences in that the Verb in these two latter sentence types cannot be additive. Indeed, the Verb in these constructions is not Foregrounded. Consider the following bare SOV sentences.

¹⁰ Note that additiveness, like contrastiveness, is not part of the Semantic-Communicative Structure of a sentence, but rather of the Rhetorical Structure.

¹¹ As a reminder, a Focalized element is in the speaker’s focus of attention (cf. footnote 5, page 4).

¹² The Semantic-Communicative-opposition of Emphasis can be roughly defined as the portion of a Semantic Structure that is presented to the Addressee by the Speaker as having a special emotive importance for him, which tends to be implemented via a special prosody. For example, in *John met a DOCTOR at the airport*, where small caps indicate heavy stress and a very emotive prosody, *doctor* is Emphasized.

- (8) a. [Lisi asks Zhangsan if he drinks this and that wine. Zhangsan answers that he does and tells Lisi the following.]

wo³ lian² [xiang¹.bin¹.jiu³]_{Foregrounded} dou¹ he¹
 I even champagne all drink
 'I even champagne drink'

- b. [Zhangsan is telling Lisi how he smokes cigars and eats expensive meals when he goes on business trips. He adds the following.]

*wo³ lian² [xiang¹.bin¹.jiu³]_{Foregrounded} dou¹ [he¹]_{Foregrounded}
 I even champagne all drink
 'I even champagne drink'

It is shown here that only the Direct Object is Foregrounded given that the only acceptable sentence is the one in (8a) where the DO only is additive. The (b) sentence is unacceptable because the Verb in bare SOV sentences is not Foregrounded and therefore cannot be additive. For the sentence in (8b) to be acceptable, an SVO sentence and the additive marker *shen⁴ zhi⁴* 'even' need to be used (the two words *shen⁴* and *zhi⁴* individually mean 'very' and 'extremely' and are translated into English simply as *even*).

- (9) wo³ shen⁴.zhi⁴ [he¹ xiang¹.bin¹.jiu³]_{Foregrounded}
 I even drink champagne
 'I even drink champagne'

Finally, let us look at SOV-*guo* sentences.

- (10) a. [Lisi names different kinds of wines. Zhangsan says he has tried them once and adds:]

wo³ lian² [xiang¹.bin¹.jiu³]_{Foregrounded} dou¹ he¹-guo
 I even champagne all drink-EXP
 'I have even champagne drunk'

- b. [Lisi and Zhangsan are at an upper-class party; caviar and champagne is being served. Lisi asks Zhangsan if he has ever eaten caviar; he says that he has and adds the following.]

*wo³ lian² [xiang¹.bin¹.jiu³]_{Foregrounded} dou¹ [he¹-guo]_{Foregrounded}
 I even champagne all drink-EXP
 'I have even champagne drunk'

Similarly to the bare SOV sentences shown in (8), the sentence in (10a) is acceptable because the additive Direct Object is Foregrounded. The (b) sentence, however, is unacceptable given that the Verb is not Foregrounded; thus this element cannot be additive.

The sentence in (10b) becomes acceptable if an SVO sentence and *shen⁴ zhi⁴* ‘even’ are used. This is illustrated below.

- (11) wo³ shen⁴.zhi⁴ [he¹-guo xiang¹.bin¹.jiu³]_{Foregrounded}
 I even drink-EXP champagne
 ‘I have even drunk champagne’

Having demonstrated that there are three subtypes of SOV sentences, I will show that SOV sentences have different Semantic-Communicative Structures than SVO and OSV sentences (see Tremblay and Beck, in preparation, for a discussion on Mandarin Chinese SVO and OSV sentences). The three word orders differ from one another in that the Direct Object (and/or the Subject) cannot be a Rhematic Focus in SOV sentences but can in SVO and OSV sentences. The Rhematic Focus supplies the value of an unknown element in a sentence that serves as an answer to a particular question. It is only obligatory in certain discourse situations, as for example in Question-Answer sequences. Let us first look at bare SOV versus OSV sentences (RhF stands for Rhematic Focus and contrastive elements are underlined in the English gloss).

- (12) [Lisi and his child are visiting Zhangsan. Zhangsan asks the child what he wants to eat and Lisi answers that the child will eat a sandwich. But his child doesn’t want to and says the following.]

- a. wo³ chi¹ [jiao³.zi]_{RhF} (SVO)
 I eat dumpling
 ‘I eat dumplings’
- b. [jiao³.zi]_{RhF, Focalized} wo³ chi¹ (OSV)
 dumpling I eat
 ‘dumplings I eat’
- c. *wo³ [jiao³.zi]_{RhF, Foregrounded} chi¹ (SOV)
 I dumpling eat
 ‘I dumplings eat’

In (12), the Direct Object *jiao³ zi* ‘dumplings’ is the Rhematic Focus and is also contrastive. In this situation, an SVO or an OSV sentence can be used while a bare SOV sentence is ungrammatical (as well as any other word order). The same holds for SOV-*le* and SOV-*guo* sentences, as shown in (13) and (14) respectively.

- (13) A: [shei²]_{RhF} chi¹-le wo³-de jiao³.zi?
 who eat-COMPL I-POSS dumpling
 ‘who ate my dumplings?’
- B1: [zhang¹.san¹]_{RhF} chi¹-le ni³-de jiao³.zi (SVO)
 zhang.san eat-COMPL you-POSS dumpling
 ‘Zhangsan ate your dumplings’
- B2: [ni³-de jiao³.zi]_{Focalized} [zhang¹.san¹]_{RhF} chi¹-le (OSV)
 you-POSS dumpling zhang.san eat-COMPL
 ‘your dumplings Zhangsan ate’
- B3: *[zhang¹.san¹]_{RhF} [ni³-de jiao³.zi]_{Foregrounded} [chi¹-le]_{Foregrounded} (SOV)
 zhang.san you-POSS dumpling eat-COMPL
 ‘Zhangsan your dumplings ate’
- (14) A: [shei²]_{RhF} chi¹-guo jiao³.zi?
 who eat-EXP dumpling
 ‘who has eaten dumplings?’
- B1: [zhang¹.san¹]_{RhF} chi¹-guo jiao³.zi (SVO)
 zhang.san eat-EXP dumpling
 ‘Zhangsan has eaten dumplings’
- B2: [jiao³.zi]_{Focalized} [zhang¹.san¹]_{RhF} chi¹-guo (OSV)
 dumpling zhang.san eat-EXP
 ‘dumplings Zhangsan has eaten’
- B3: *[zhang¹.san¹]_{RhF} [jiao³.zi]_{Foregrounded} chi¹-guo (SOV)
 zhang.san dumpling eat-EXP
 ‘Zhangsan dumplings has eaten’

In (13) and (14), the Rhematic Focus is *Zhangsan*. In both datasets, the Subject can be a Rhematic Focus in the SVO and OSV sentences but it cannot in the SOV ones (any other word order is unacceptable).

To recapitulate the section, SOV sentences have been found to encompass three distinct subtypes: (i) bare SOV sentences, (ii) SOV-*le* sentences, and (iii) SOV-*guo* sentences. It was established that even though all three encode Foregrounded Direct Objects, only bare SOV constructions are inherently contrastive, and only SOV-*le* constructions also encode Foregrounded Verbs. Finally, it was shown that SOV sentences have a distinct Semantic-Communicative Structure than SVO and OSV sentences.

4 Conclusion

This paper has elaborated on Croft's (2001) notion of 'meaning', more specifically, on that part called 'information structure' by Lambrecht (1994) or 'semantic-communicative structure' by Mel'čuk (2001), an aspect of the Radical Construction Grammar framework that was left under-described. This was done by examining Mandarin Chinese SOV sentences. Using Mel'čuk's (2001) theory of Semantic-Communicative Structure, it was demonstrated that there are three SOV constructions, namely: (i) bare SOV constructions, (ii) SOV-*le* constructions, and (iii) SOV-*guo* constructions, all of which encode Foregrounded Direct Objects. Of the three, only the bare SOV construction is inherently contrastive, and only the SOV-*le* construction encodes, in addition, Foregrounded Verbs. These constructions are schematized in Figures 5-7, where FOR stands for Foregrounded, CONT for CONTRASTIVE, COMPL for COMPLETIVE aspect, and EXP for EXPERIENCE aspect.

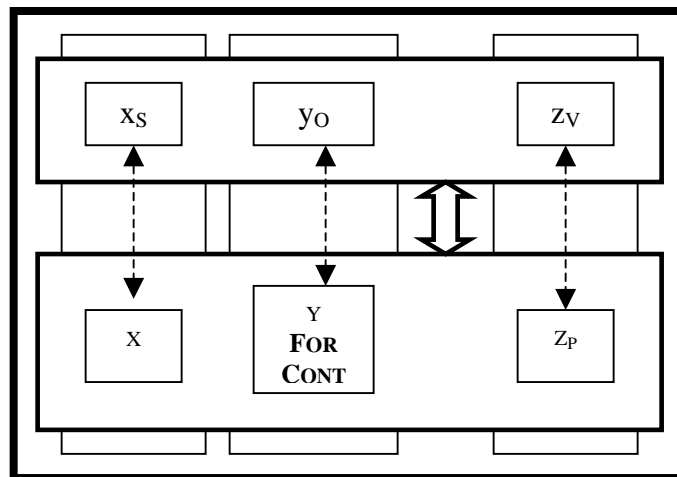

Figure 5
The bare SOV construction.

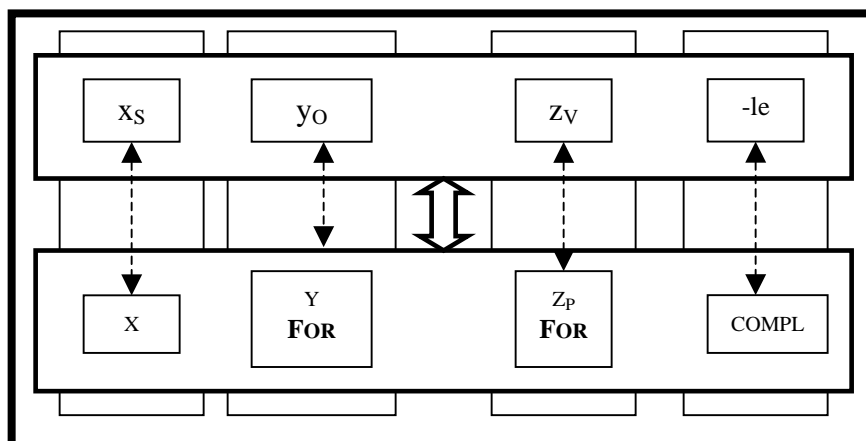

Figure 6
The SOV-*le* construction.

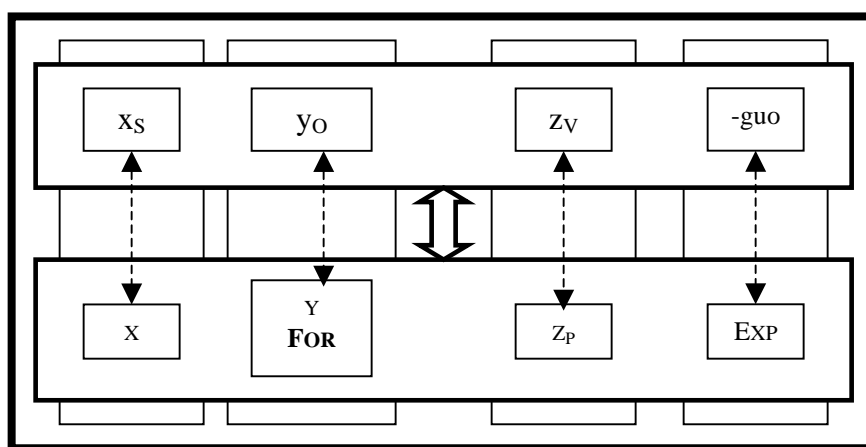

Figure 7
The SOV-*guo* construction.

Moreover, it was shown that the three SOV constructions are different from SVO and OSV constructions in that the Subject and/or the Direct Object can be a Rhematic Focus in the two latter constructions, but not in the three SOV constructions.

SOV sentences have been treated until now as one single type of sentence (Li Shen 1990, Shyu 2001, and Li Eden Sum-hung 2005 among others). However, it was shown that there are three distinct types of SOV sentences. Indeed, the meaning associated with each of these SOV sentences is non-decomposable, that is, it is contingent on the whole sentence and not on any specific component of the sentence. As such, it is probable that these constructions are represented in the mind of a speaker. What is all the more interesting is that these constructions do not encode a specific Semantic Structure (i.e., a propositional meaning), but

rather a specific Semantic-Communicative Structure in addition to, in the case of bare SOV sentences, a specific Rhetorical Structure (i.e., contrastiveness).

Acknowledgments

I wish to thank David Beck, Igor Mel'čuk, Zhu Xiaolei, Lin Jing Xia, Chun Ling, Yin Hui, and all the informants in China and Canada who have helped me with this study. This paper could not have been written without the aforementioned people's help. The present paper has been supported in part by a Chinese Graduates Association of Alberta Graduate Award, a Province of Alberta Graduate Fellowship, and a SSHRC Doctoral Fellowship (#752-2006-1315)

References

- Croft, W. (2001). *Radical Construction Grammar. Syntactic Theory in Typological Perspective*. Oxford: Oxford University Press.
- Fillmore, C.J., Kay, P. & O'Connor, C. (1988). Regularity and idiomaticity in grammatical constructions: The case of *let alone*. *Language*, 64.3, 501-38.
- Israel, M. (1996). The way construction grow. In A.E. Goldberg (ed.). *Conceptual Structure, Discourse and Language*, pp. 217-30. Stanford: Center for the Study of Language and Information.
- Lambrecht, K. (1994). *Information Structure and Sentence Form. Topic, Focus, and the Mental Representation of Discourse Referents*. Cambridge: Cambridge University Press.
- Langacker, R.W. (1987). *Foundations of Cognitive Grammar. Vol. I: Theoretical Prerequisites*. Stanford: Stanford University Press.
- Li, E.S.-h. (2005). Voice in Chinese. A systemic functional perspective. *Functions of Language*, 12, 181-203.
- Li, S. (1990). *On SOV Structure in Contemporary Mandarin Chinese*. PhD dissertation, The University of Nebraska.
- Mel'čuk, I.A. (1988). *Dependency Syntax: Theory and Practice*. New York: SUNY Press.
- Mel'čuk, I.A. (2001). *Communicative Organization in Natural Language: The Semantic-Communicative Structure of Sentences*. Amsterdam and Philadelphia: John Benjamins.
- Po-Ching, Y. & Rimmington, D. (2004). *Chinese: A Comprehensive Grammar*. New York and London: Routledge.
- Rice, S. (1987). Towards a transitive prototype: Evidence from some atypical English passives. In J. Aske, N. Beery, L. Michaelis, & H. Filip (eds.). *Proceedings of the 13th Annual Meeting of the Berkeley Linguistic Society, February 14-16, 1987, General Session and Parasession on Grammar and Cognition*, pp. 422-34. Berkeley: Berkeley Linguistics Society.

- Rice, S. (1993). The so-called pseudo-passive revisited (by a cognitive linguist). *Studi Italiani di Linguistica Teorica e Applicata*, 3, 567-99.
- Shyu, S-i. (2001). Remarks on object movement in Mandarin SOV order. *Language and Linguistics*, 2, 93-124.
- Shyu, S-i. (2004). (A)symmetries between Mandarin Chinese *lian ...dou* and *shenzhi*. *Journal of Chinese Linguistics*, 32, 81-128.
- Sun, C.-F. & Givón, T. (1985). On the so called SOV word order in Mandarin Chinese: A quantified text study and its implications. *Language*, 61, 329-51.
- Tremblay, A. & Beck, D. (In preparation). *Semantic-Communicative-Oppositions and Word Order in Mandarin Chinese*.
- Wang, Y. (1994). *Discourse Grounding. The Morphosyntax of the Mandarin Direct Objects*. PhD dissertation, University of Alberta.
- Wei, H.-m. (1989). *Word Order of Mandarin Chinese*. PhD dissertation, Michigan State University.
- Zhang, N. (2000). Object shift in Mandarin Chinese. *Journal of Chinese Linguistics*, 28, 201-246.
- Žolkovskij, A. and Mel'čuk I.A. (1967). O semanticeskom sinteze [On semantic synthesis]. *Problemy kibernetiki*, 19, 177-238. [French translation: *T.A. Information* (1970), 2, 1-85.]

Preliminary Investigation of the Relationship between Morphology and Phonology in SENĆOŦEN (Saanich)

Janet Leonard

University of Victoria
jleonard@uvic.ca

ABSTRACT

In this paper, I argue that stress in SENĆOŦEN is sensitive to the morphological structure of the word. Supporting arguments presented by Kiyota (2002) I provide further evidence that trochaic feet are aligned to the right edge of a morphological stem. I look at two types of morphologically complex forms. The first are words which involve reduplication and the second are those that involve lexical suffixes. It is the case that these types of words do not always follow the default penultimate stress system previously proposed for SENĆOŦEN (see Leonard 2006; Montler 1986). However, rather than assuming that stress in SENĆOŦEN is highly complex with inherently strong and weak morphemes competing for stress (see Montler 1986, Kiyota 2002), I propose that a word can have more than one morphological stem and that stress prefers to target a multi-syllabic morphological stem rather than the rightmost one.

Keywords: SENĆOŦEN; Saanich; Salish; Phonology; Morphology; Stress.

1 Introduction

Building on previous literature which proposes that Salish words have an internal structure of phonological and morphological domains (Bar-el and Watt 2000, Blake 1996, 2000, Czaykowska-Higgins 1996, 1998, 2004, Dyck 2004, Shaw 2002, to appear, Watt 2001, Willett 2003), I argue that stress assignment in SENĆOŦEN (North Straits Salish) is sensitive to a word's morphological structure. Evidence for this claim is provided by examining the stress properties of morphologically complex words which include reduplication and lexical suffixes.

I have organized this paper into five sections. In section 2, I discuss the previous literature concerning phonological and morphological domains and discuss how these theoretical frameworks have been applied to the Salish languages. In section 3, I provide a basic phonological description of SENĆOŦEN. This includes the segment inventory and the basic stress system. Section 4 is where I argue that the phonological process of stress is sensitive to the morphological word in SENĆOŦEN. Evidence to support this argument comes from an examination of the stress properties of words which include reduplication and

lexical suffixes. Section 5 is a conclusion. All the data, unless otherwise noted, are from Montler (1986).

2 Theoretical assumptions

In her dissertation, Dyck (2004) provides a summary of previous work on phonological domains. I repeat here the parts of her summary which I feel are pertinent to this paper. She says that the need to distinguish between prosodic and morphological structure has been recognized for sometime: see Aoki (1966), Dixon (1977), Liberman and Prince (1977), Booij (1983), Booij & Rubach (1984), Nespor (1986), Nespor & Vogel (1986), Selkirk (1980), McCarthy & Prince (1986). All these researchers recognize the existence of a prosodic lexical entity. Often this is called the phonological or prosodic word and it is distinct from the morphological word. Motivation for such a structure comes from observations that phonological rules do not apply across an entire grammatical word. A typical hierarchy is one with the following constituents:

- (1) Prosodic Hierarchy (based on Selkirk 1980 in Dyck 2004:150)

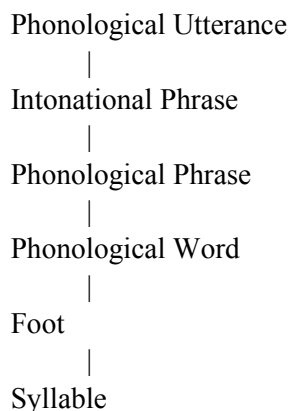

Dyck (2004:151) also provides a summary of more recent work in the area of prosodic domains. She says that in this more recent work (for instance, in Inkelas 1993; Czaykowska-Higgins 1996, 1998; and Downing 1999), researchers have argued for more lexical substructure below the phonological word and above the metrical categories foot and syllable. Dyck (2004:151) interprets these substructures as the phonological stem and phonological root.

(2) P-Hierarchy (adapted from Inkelas 1993:80, in Dyck 2004:151)

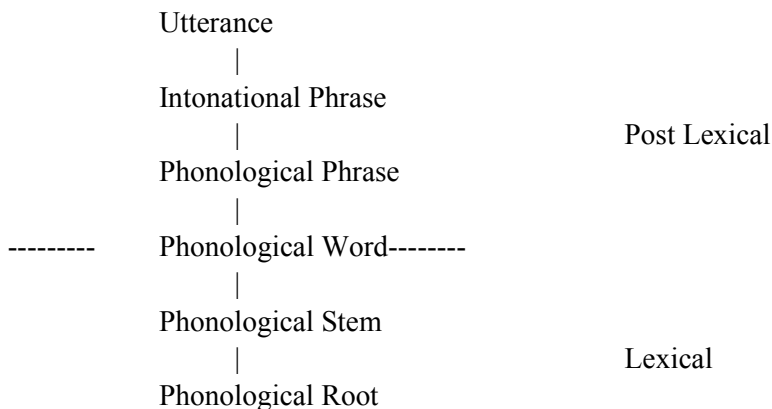

Evidence for these additional categories is based on observations that phonological rules sometimes require reference to a prosodic domain which is below the phonological word and outside of the metrical structure. For Inkelas (1993) metrical structure exists as a separate and distinct hierarchy from the P-structure. Inkelas (1993), assumes a co-presence model whereby words have two independent hierarchical structures, one phonological and one morphological. She further assumes that phonological processes such as stress assignment only have access to the phonological structure.

Departing from this assumption, Shaw (2004) proposes that in Hən'q'əmin'əm (Musqueam, Salish) stress has direct access to the morphological structure. By examining data involving reduplication of CVC roots, Shaw proposes that Hən'q'əmin'əm stress is aligned to the left edge of a morphological root.

Following Shaw (2004), I argue in this paper, that it is within some morphological domain that stress assignment applies. I assume, following Kiyota (2002), that this domain is a morphological stem. The basic rules governing stress assignment in SENĆOŦEN are as follows: 1) a trochaic foot must be aligned with the right edge of a morphological stem (Kiyota 2002), 2) stress feet in SENĆOŦEN are trochaic (Kiyota 2002) and 3) foot construction must not break up semantically close morphemes. I further propose that a morphological word can contain more than one morphological stem, and that faithfulness to a lexical unit coupled with stressing of a trochaic foot are more important than aligning stress with the rightmost morphological stem.

I follow Czaykowska-Higgins (1998), in assuming that the morphological word is made up of a core lexical root, which is termed the morphological root, the morphological stem, which contains the morphological root, plus lexical morphemes [LEX] that extend the meaning of the root [RT] and the morphological word, which contains morpho-syntactic morphology [MS] that adds syntactic meaning to the root. The types of SENĆOŦEN morphemes I consider to have lexical meaning include the class of lexical suffixes as well as actual and plural morphology. Below, I provide a schema of the SENĆOŦEN morphological

word based on Czaykowska-Higgins (1998). I leave the motivation of such a structure for future research.

(3) $[_{MW} MS-[_{MS} LEX-[_{MR} ROOT]-LEX]-MS]$

I assume that the phonological structure of the word is not isomorphic with the morphological structure of the word. The phonological domain where stress is assigned, as I have suggested, is a maximally two syllable domain. This domain can include the morphological root with either a lexical morpheme, or it can include the morphological root with a morpho-syntactic morpheme. It can comprise of a morphological root alone, if that root is disyllabic. Below, I present a few examples of the types of morphemes which can be housed within the proposed phonological domain for stress in SENĆOŦEN.

(4) $MS-LEX-[_P MROOT]-LEX-MS$

(5) $MS-LEX-[_P MROOT-LEX]-LEX-MS$

(6) $MS-[_P LEX-MROOT]-LEX-MS$

(7) $MS-LEX-MROOT-[_P LEX]-LEX-MS$

Before motivating the interaction between morphology and phonology in SENĆOŦEN, it is first necessary to outline the basic phonological properties of the language. I do this in the following section and return to the morpho-phonological properties of SENĆOŦEN stress in section 4.

3 Phonological properties of SENĆOŦEN

In this section, I discuss the phonological properties of SENĆOŦEN. In section 3.1, I provide the consonant and vowel inventory. In section 3.2, I discuss the difference between full vowels versus schwa and finally in 3.2, I present the basic stress system that has been proposed for SENĆOŦEN.

3.1 Segment inventory

As in the other Salish languages, the consonant inventory of SENĆOŦEN is extensive, with a total of 36 contrastive segments.

(8) SENĆOŦEN consonant inventory (Montler 1986: 7)

p	t	č	(k)	k ^w	q	q ^w	
p̣	ṭ ⁰ ṭ'	č̣		ḳ ^w	q̣	q̣ ^w	ʔ
	θ s	ʦ		x ^w	š	š ^w	h
m	n	l		w	ŋ		
ṃ	ṇ	ḷ		ẉ	ŋ'		

The vowel system, again typical of the Salish languages, consists of four vowels and schwa.

(9) SENĆOŦEN vowel inventory (Montler 1986: 7)¹

i	u
e	ə
	a

3.2 *Properties of schwa*

Schwa in the Salish languages is considered to be predictable, serving to break up illicit consonant clusters (Kinkade 1998). Schwa is overlooked, by the phonology, in most cases of stress assignment in the sense that, if there is a schwa and full vowel in a root, stress will fall on the full vowel even if this results in a violation of the regular stress pattern. Shaw et al (1999) assume that full vowels have moraic structure and that schwa does not. Also they hypothesize that schwa has no place features while the full vowels do. The representation for full vowels and schwa is given in (12).

(10) Representation of full vowel and schwa (Shaw et al 1999: 5)

	a. full vowel	b. schwa
Nucleus	Nuc	Nuc
Moraic Weight	μ	
Root Node	o	
Features	[f]	

3.3 *Basic stress*

Montler (1986: 7) observes that the basic stress system in SENĆOŦEN is to stress the first full vowel in a word. If there is no full vowel then stress the first schwa. Below, I

¹ I consider schwa to be predictable (Leonard 2006); however, in this paper I remain neutral about whether or not it is underlying. Montler (1986) includes schwa in his underlying representations and because I am using his data I will do the same in this paper.

exemplify this basic stress system with disyllabic roots. The examples in (11-13) show that roots containing two full vowels will stress the first full vowel.

- (11) sk^wati 'crazy'
 (12) sq^wáŋi? 'head'
 (13) č^wéwi? 'dish'

Examples (14-19) show that disyllabic roots containing a full vowel and a schwa will stress the full vowel.

- (14) sqé^təǰ 'clam fork'
 (15) spé[?]x^wəń 'misty'
 (16) sŋénət 'mountain'
 (17) sqəl^wéw 'beaver'
 (18) səní? 'Oregon grape berry'
 (19) ʔən[?]ax^w 'bring over'

Examples (20-22) show that roots containing two schwas will stress the first schwa.

- (20) tən^wəx 'earth'
 (21) qəl^wəǰ 'salmon eggs'
 (22) k^wəl^w 'skin'

For these very basic forms the proposed analysis is that stress feet are trochaic and that SENĆOTEN is sensitive to the weight distinction between full vowel and schwa (Leonard 2006)

4 The morpho-phonological properties of SENĆOTEN stress assignment

In this section, I argue that the phonological property of SENĆOTEN stress assignment is sensitive to the morphological structure of the word. I examine morphologically complex words involving both lexical suffixes and/or reduplication. The stress facts of these types of words support the existence of a morphologically sensitive trochaic foot where stress applies.

This section is organized as follows: 4.1 is a discussion of the stress facts in words involving reduplication, and 4.2 is a discussion of the stress facts in words with lexical suffixes.

4.1 Reduplication

Reduplication is used in SENĆOTEN to denote many morphological meanings. These include: 'plural', 'diminutive', 'characteristic' and 'actual' (also known as progressive). In this paper, I focus on the 'actual' and 'plural' reduplication.

4.1.1 CV-Actual

The ‘actual’ reduplication presents two problems. The first is that sometimes the base is stressed and sometimes the reduplicant is stressed. The second problem is that in all cases it appears that the ‘actual’ forms are not following the basic stress system. However, a clear pattern presents itself when we take a closer look at the data. In (23-35) we see that stress falls on the base. Note that all the morphological roots that the ‘actual’ are formed on are disyllabic. The reduplicant and the root form one morphological stem. Following Kiyota (2002) I assume that a trochaic foot is constructed to the right edge of this morphological stem. These forms are following the basic stress pattern observed by Montler (1986), Kiyota (2002) and Leonard (2007).

- | | | | | |
|------|-----------|-------------|--------|-----------|
| (23) | šəšiwəʔ | ‘urinating’ | šiwəʔ | ‘urinate’ |
| (24) | kʷəkʷéčəŋ | ‘yelling’ | kʷéčəŋ | ‘yell’ |
| (25) | tətíləm | ‘singing’ | tíləm | ‘sing’ |

In contrast there are other examples of the ‘actual’ where the reduplicant is stressed. In these cases, the morphological root is only one syllable. The reduplicant and the root together constitute a morphological stem. This stem is also a trochaic foot thus the stress pattern of these types of words is as expected.

- | | | | | |
|------|---------|----------------------|------|---------------|
| (26) | qéqəŋ | ‘stealing’ | sqəŋ | ‘It’s stolen’ |
| (27) | tétiʔ | ‘canoe racing’ | téy | ‘canoe’ |
| (28) | sqéqəw | ‘He’s resting’ | qew | ‘rest’ |
| (29) | qʷəqʷəl | ‘He’s saying it now’ | qʷəl | ‘say’ |
| (30) | čəyáq | ‘He’s getting big’ | čáq | ‘big’ |

The examples in (31) and (32) consist of a morphological root that is one syllable.

- | | | | | |
|------|------------------------|--------------------|---------|---------------|
| (31) | kʷiwəntəl ² | ‘They’re fighting’ | kʷintəl | ‘They fought’ |
| (32) | ʰitəkʷsən | ‘He is tripping’ | ʰikʷsən | ‘He tripped’ |

These roots are concatenated with a suffix (in some cases grammatical and in other lexical). They also have undergone reduplication. If all the morphemes in this word constitute one morphological stem then we would expect penultimate stress. In this case it appears that a trochaic foot is not aligned with the right edge of the morphological stem. I argue that in these cases the suffixes start their own morphological stem. It may be the case that these types of suffixes are in a compounding relationship with the first morphological stem (see

² The first consonant in this root surfaces as kʷ in the onset unless it is glottalized then it will surface as w (Montler 1986).

Gerdts, 2003). The assignment of stress targets the morphological stem that has more than one syllable and aligns to its right edge.

4.1.2 CVC-Plural

All the examples of CVC- plural reduplication in Montler (1986) are built on morphological roots that contain two syllables. In all cases, to lose any of this morphological structure would result in the loss of the core meaning. I assume then that the reason that the reduplicant is not stressed in these examples is simply because a trochaic foot is aligned with the right edge of the morphological stem.

- | | | | | |
|------|-------------------------|----------------|----------------------|------------|
| (33) | sʔəlʔélʔəx ^w | ‘medicines’ | sʔélʔəx ^w | ‘medicine’ |
| (34) | sʔəlʔéləx ^w | ‘elders’ | sʔéləx ^w | ‘elder’ |
| (35) | ŋəŋəŋəŋəʔs | ‘His children’ | ŋəŋəʔ | ‘children’ |

4.1.3 -Ci- Plural

Again, the Ci- plural reduplication examples found in Montler (1986) only include examples of disyllabic morphological roots. As in section 4.1.1, I assume that stress is aligned to the right edge of a morphological stem.

- | | | | | |
|------|-----------|------------------|---------|---------|
| (36) | swəwíltən | ‘nets’ | swáltən | ‘net’ |
| (37) | čəčínəs | ‘teeth’ | čánəs | ‘tooth’ |
| (38) | ŋəŋíqsən | ‘a lot of noses’ | ŋáqsən | ‘nose’ |

4.2 Lexical suffixes

4.2.1 Definition of lexical suffixes

According to Montler (1986: 64) lexical suffixes are derivational morphemes with substantive root-like meanings which always occur bound to a root. Many Salishanists have proposed that lexical suffixes are in fact bound roots as opposed to suffixes (Carlson 1990, Kinkade 1998, Czaykowska-Higgins 2004, Urbanczyk 2000, Blake 1998). One of the reasons to suppose this is the case is that disyllabic lexical suffixes always carry primary stress.

In this section, I focus on two words which both contain two monosyllabic lexical suffixes. These words prove to be exceptions to the general stress pattern outlined in Section 3. The stress facts of these lexical suffixes provide further evidence that the phonological process of stress assignment is sensitive to morphological structure in SENĆOŦEN.

4.2.2 Lexical suffix evidence for phonological root domain

Leonard (2006) accounts for many forms which involve lexical suffixes by proposing that trochaic feet are aligned to the right edge of a word. The majority of three syllable SENĆOŦEN words containing lexical suffixes do in fact exhibit a penultimate stress pattern.

Kiyota (2002) proposes that stress is assigned to the right edge of a morphological stem. This too predicts that stress will be penultimate. Kiyota's (2002) further assumes that each SENĆOFEN morphological word has only one morphological stem. In this paper, I claim that there can be more than one morphological stem present in a SENĆOFEN morphological word.

As predicted by both Kiyota (2002) and Leonard (2006) and illustrated in Leonard (2006), the majority of three syllable words with lexical suffixes exhibit penultimate stress. I provide an example below.

- (39) $x^w-t^{\theta}ək^w=sən=əŋ$ $sən$
 LOC-wash=LS(foot)-MID 1SUBJ
 'I'm washing my feet' (Leonard 2006)

Leonard (2006) also provides a few examples of words containing lexical suffixes which do not have penultimate stress. Instead these forms, which always contain more than one lexical suffix, tend to have ante-penultimate stress. In this section, I illustrate how the claim that a morphological word contains more than one morphological stem accounts for apparently exceptional forms. Below, I present two of these exceptional cases.

- (40) $x^w-sé=nəč=qən$ / $x^w-se=nəč=qən$ /
 LOC-?(=LS)bottom=(LS)throat
 'Saanich language'
- (41) $qət=sən=tən$
 wrap around=(LS)foot=(LS)instrument
 'Dancer's leg wraps'

The stress in these forms is predicted to be on the penultimate syllable. In (40) it should be the lexical suffix 'bottom' that is stressed as it has an underlying full vowel. In (41) it should be the lexical suffix 'foot' because stress is assumed to align to the right edge of the word. However, the stress assignment of these forms is accounted for if we assume that the morphological root and the first lexical suffix together form a morphological stem which is distinct from the second lexical suffix. Below I present the domain breakdowns for the word.

- (40) MS-[_{MS}MROOT=LEX][_{MS}=LEX] x^w- [_P $sé=nəč$] [=qən]
- (41) [_{MS}MROOT=LEX][_{MS}=LEX] [_P $qət=sən$] [=tən]

There is also a semantic reason to suppose that the words in (40) and (41) would be structured the way I have proposed. In example (40), the morphemes residing within the first morphological stem mean 'Saanich', and the lexical suffix outside of that domain means

‘throat’. The overall meaning is ‘the language of Saanich’. I argue that the lexical suffix is modifying the word ‘Saanich’ and that if stress were on the lexical suffix =neč ‘bottom’, then we would have a situation where some morpheme ‘se’ is modifying ‘nečqən’ which may perhaps mean something like ‘bottom language’. In short the semantic meanings of the two lexical suffixes do not combine in a meaningful way, but the morphemes ‘se’ and ‘neč’ do. Below, I present a diagram showing the semantic structure of the example in (42).

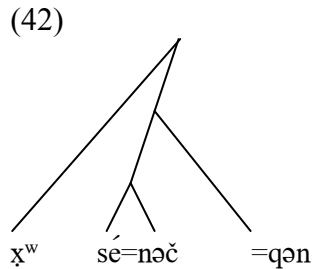

Revithado (1999) says that the placement of stress in polysynthetic languages is governed by principles of word composition and head dominance. When the morpho-syntactic structure is projected onto the prosodic structure the most important constituent surfaces with main stress. In the case of (42) the prosodic/phonological structure is mirroring the morpho-syntactic structure. The first morphological stem is the most important constituent in this word and it receives main word stress.

In sum, the default stress pattern in SENĆOFEN is to align a trochaic foot to the right edge of the word. However, foot construction is sensitive to the bond between morphemes. If two or more morphemes form a stem then stress is aligned to the right edge of that stem.

5 Conclusion

This paper argues that the phonological process of stress assignment in SENĆOFEN is sensitive to the morphological structure of a word. Stress in SENĆOFEN is governed by the following principles. 1) A trochaic foot is aligned to the right edge of a morphological stem. 2) A word can contain more than one morphological stem. 3) Trochaic feet will not be built across two morphological stems if one is disyllabic.

Evidence for this type of stress system is provided by analyzing first morphologically complex words involving reduplication. These kinds of words illustrate that if a disyllabic root is reduplicated the reduplicant will not be stressed. This is because the morphological root and the reduplicant together constitute a morphological stem and trochaic feet are aligned to the right edge of a morphological stem. The reduplication of a monosyllabic morphological root results with stress on the reduplicant regardless of whether or not there is a suffix attached to the morphological root. In these cases the suffix forms its own morphological stem. Trochaic feet are constructed around the morphological stem which is

disyllabic rather than being constructed across two morphological stems. It is for this reason that trochaic feet can not simply be aligned to the right edge of a word.

The second piece of evidence comes from the examination of forms containing lexical suffixes, which do not follow the basic stress system of the language. These forms also illustrate that the construction of trochaic feet pays attention to the morphological structure of a word. In these cases, the words contain two morphological stems stress is assigned to the stem which is disyllabic. Importantly, stress does not break up a morphological stem, i.e. a lexical unit. This is why a trochaic foot is not aligned with the right edge of the rightmost morphological stem.

In addition to predicting the stress assignment of some apparent exceptional forms left unaccounted for in Leonard (2006), this preliminary work provides a starting point to a greater understanding of the phonological and morphological structure of SENĆOŦEN words. More fieldwork is necessary to investigate this topic further.

References

- Aoki, H. 1966. Nez Perce vowel harmony and Proto-Sahaptian vowels. *Language* 42: 759-767.
- Booij, Geert. 1983. Principles and parameters in Prosodic Phonology. *Linguistics* 21: 249-280.
- Booij, Geert. And Jerzy Rubach. 1984. Morphological and prosodic domains in Lexical Phonology. *Phonology Yearbook 1*: 1-27.
- Blake, Susan J. 1998. The OCP and Root-Affix Faithfulness in St'át'imcets (Lillooet Salish). Paper presented at the 33rd ICSNL.
- Carlson, Barry. F. 1990. Compounding and lexical affixation in Spokane. *Anthropological Linguistics* 32:69-82.
- Czaykowska-Higgins, Ewa. 1998. The morphological and phonological constituent structure of words in Moses-Columbia Salish (Nxa'amxcín). In Czaykowska-Higgins, E. and M. D. Kinkade (eds.), *Salish languages and linguistics*, 153-195. Berlin: Mouton de Gruyter.
- Czaykowska-Higgins, Ewa. 2004. The morphological and phonological status of Nxa'amxcin lexical suffixes. In Donna Gerdts and Lisa Matthewson (eds.) *Studies in Salish linguistics in honour of M. Dale Kinkade*. University of Montana Occasional Papers in Linguistics No. 17.
- Dixon, R.M.W. 1977. Some phonological rules of Yidij.. *Linguistic Inquiry* 8: 1-34.
- Downing, Laura. 1999. Prosodic stem ≠ prosodic word in Bantu. In T. Alan Hall and Ursula Kleinhenz (eds), 74-98.
- Dyck, Ruth. 2004. *Morphological and Prosodic Factors in Squamish (Skwxwú7mesh)*

- Stress Assignment*. UVic Ph.D. Dissertation.
- Gerds, Donna. 2003. The morphosyntax of Halkomelem lexical suffixes. *International Journal of American Linguistics*. 69(4):345-356.
- Kinkade, Dale. M. 1998. On the origin of Salish lexical suffixes. *Papers for the 33rd International Conference on Salish and Neighbouring Languages* 33:266-295.
- Kiyota, Masaru. 2003. Plural allomorphs in Saanich. Phonology generals paper. University of British Columbia.
- Lieberman, Mark and Alan Prince. 1977. On stress and linguistic rhythm. *Linguistic Inquiry* 8: 249-335.
- Leonard, Janet 2006. *Formalising stress in SENĆOŦEN*. Uvic MA Thesis..
- Montler, Timothy. 1986. *An outline of the morphology and phonology of Saanich, North Straits Salish*. University of Montana Occasional Papers in Linguistics No. 4.
- Montler, Timothy. 1989. Infixation, reduplication and metathesis in the Saanich actual aspect. *Southwest Journal of Linguistics*, 9, 92-107.
- Montler, Timothy. 1991. Saanich North Straits classified word list. Hull, QC: Canadian Museum of Civilization, Mercury Series. No. 119.
- Nespor, Marina. 1986. The phonological word in Greek and Italian. In H.Anderson (ed.), *Sandhi Phenomena in the Languages of Europe*. Berlin: Mouton, 65-74.
- Nespor, Marina and Irene Vogel. 1986. *Prosodic Phonology*. Dordrecht: Foris.
- Revithado, Anthi 1999. Headmost accent wins.: head dominance and ideal prosodic forms in lexical access systems. The Hague: Holland Academic Graphics.
- Selkirk, Elizabeth O. 1980. The role of prosodic categories in English word stress. *Linguistic Inquiry* 11: 563-605.
- Shaw, Patricia A., S. J. Blake, Jill Campbell, and Cody Shepherd. 1999. Stress in hən'q'əmin'əm' (Musqueam) Salish. *Workshop on the Structure and Constituency Languages of the Americas* 4. UBC.
- Shaw, Patricia A. in press. Inside access: the prosodic role of internal morphological constituency. In Hanson, Kristin and Sharon Inkelas (eds.) *Kiparsky Festschrift*. MIT Press.
- Turner, Claire K. 2006. *The SENĆOŦEN resultive construction*. Uvic MA Thesis.
- Urbanczyk, Suzanne. 1996. Patterns of reduplication in Lushootseed. Phd. Dissertation, University of Massachusetts, Amherst. [Published 2001, New York: Garland.]
- Watt, Linda Tamburri 2001. Stress and strong suffixes in Squamish Salish. Ms., University of British Columbia.
- Willett, Marie Louise. 2003. A grammatical sketch of Nxa'amxcin (Moses-Columbian Salish). Phd. Dissertation. University of Victoria.

The Afterlife of Morphemes:
Rendaku and the Search for Ghosts
 in Japanese Morphophonology
 Thomas J. Magnuson

University of Victoria
thomasm@uvic.ca

ABSTRACT

Rendaku, or sequential voicing in Japanese compounds, has been characterized in terms of autosegmental phonology as being the product of a floating morpheme whose only content is the feature [+voice]. This ‘ghost’ either appears or does not (i.e., voicing occurs or does not) depending on a number of phonological and lexical circumstances. This report is a preliminary exploration of potential alternatives to the autosegmental account. Borrowing from Rosen (2003), Gordon (2005), and Martel (2009), the potential for prosodic boundaries and compound length as explaining *rendaku* is explored with a view toward incorporating the idea of perceptual salience into the dynamics of sequential voicing. While the present investigation falls short of complete exorcism of *rendaku*’s ghostly morpheme, directions for future research are suggested whereby such may eventually be possible.

Keywords: Japanese; *rendaku*; sequential voicing; compound words; prosodic boundaries.

1 Introduction

Compound words in Japanese display a systematic pattern whereby the first obstruent of the second member of the compound becomes voiced. Known as *rendaku*, or sequential voicing, this process is subject to a number of restrictions which make reference to various aspects of the words involved. Lexically, *rendaku* is associated mainly with native Japanese words as opposed to Chinese or other foreign loanwords. Phonologically, its application or non-application depends on whether or not there is already a voiced obstruent in the second conjunct: if there is, *rendaku* is blocked. In terms of phonological domains, then, we have a process which occurs at the edges of two entities which bring with them their own particular lexical and morphological baggage. Current approaches to *rendaku* (Ito & Mester (I&M), 2003; Fukazawa & Kitahara (F&K), 2001; Rosen, 2003) make reference to an invisible linking morpheme, or ‘ghost’ of sorts, which alights onto obstruents making them [+voice]. In this paper I argue that the ghost may be a remnant of post-nasal voicing assimilation

(Unger, 1975; 1993). I also take the position that while autosegmental approaches to *rendaku* account for many idiosyncrasies, these accounts lack explanatory appeal. In light of this, I borrow the concepts of *striping* and *counter-striping* (Martel, 2009) and suggest that the prosodic length of compounds manipulates perceptual salience so as to heighten or decrease the psychological distance between the compounded elements. Insofar as this structural investigation is not enough to account for key idiosyncrasies, I also argue that Exemplar-dynamically motivated effects of word frequency can account for structural exceptions.

This exploration of sequential voicing first reviews in more detail what exactly *rendaku* is (§2), and the types of compound words and environments it is associated with (§2.1 ~ §2.3). Section 3 delves into possible explanations and accounts of *rendaku*, and §3.1 ~ §3.2 brings our search for morphological ghosts to its fruition. Then, in §3.3, a functional alternative to autosegmental approaches is explored with reference to the Exemplar Dynamics model proposed by Pierrehumbert (2001) and the concept of varying degrees of perceptual salience at prosodic boundaries (Gordon 2005, Martel 2009).

2 Preliminaries: What is *rendaku*?

The term *rendaku* literally means ‘sequential (*ren*) warping (*daku*),’ and is used to describe the phenomenon in Japanese compound word formation whereby the first obstruent of the second member of the compound becomes voiced, as in (1) and (2):

- (1) *kuti* ‘mouth’ + *kuse* ‘habit’ → *kuti+guse* ‘trademark phrase’
 (2) *hi* ‘day’ + *hi* ‘day’ → *hi+bi* ‘days’

In (1) the initial obstruent [k] in the second component of the compound, *kuse* (‘habit’) voices to [g]. With (2), *hi* (‘day’) reduplicates to form the plural, and the initial obstruent [h] undergoes voicing to become [b]¹. It is important to note, however, that there are many exceptions to the process based on a variety of factors including (among others): compound type (sub- versus coordinate), lexical stratum (native versus non-native words), and phonological environment. The sections that follow provide a more detailed account of the conditions where *rendaku* does and does not occur.

2.1 Compound types: roots vs. words

It is worthwhile here to distinguish between what I refer to as native Japanese *words* Chinese *roots*, which rarely stand on their own as independent words. Chinese roots are symbolized in orthography by individual *kanji* characters and are typically bound to other Chinese roots. Combined into multiple-root compounds, their phonological form is a concatenation of Japanized renditions of the original Chinese sounds associated with the

¹ It bears mention that, in Japanese, [h] behaves such that its voiced counterpart is [b].

given characters. Orthographically speaking, where *kanji* characters occur on their own, their ‘Yamato’ (native) readings are typically used. Throughout this paper I will use the term *root* to mean the bound, morphological roots (separated by hyphens ‘-’) associated with the Chinese loanwords described above. Although unsatisfactory in its vagueness, the term *word* will refer to any morphological element that can grammatically ‘stand on its own.’

Rendaku is generally thought of as a non-productive process which applies only to the native, or ‘Yamato’ stratum² of the lexicon, but there are in fact examples that go against this presumption (Rosen, 2003):

- (3) *yu* ‘hot water’ + *to-hu* ‘tofu’ → *yu+do-fu* ‘hot tofu’
**yu+to-fu*
- (4) *hi-koo-ki* ‘airplane’ + *kumo* ‘cloud’ → *hi-koo-ki+gumo* ‘vapour trail’
**hi-koo-ki+kumo*
- (5) *kami* ‘paper’ + *hi-koo-ki* ‘airplane’ → *kami+hi-koo-ki* ‘paper airplane’
**kami+bi-koo-ki*

In (3), *yu* (‘hot water’) is a native Japanese word whereas *to-hu* (‘tofu’) is an established Chinese loanword. Nonetheless, the initial [t] in *to-hu* voices to [d], exhibiting sequential voicing contrary to the idea that *rendaku* is limited to only native words. Example (4) also illustrates that *rendaku*-eligible compounds are not necessarily those whose members are both native to Japanese. The word for ‘airplane’ is a combination of three Chinese bound roots: *hi* (‘fly’), *koo* (‘go’), *ki* (‘machine’). When the native word *kumo* (‘cloud’) is combined its initial [k] undergoes voicing. If, as in (5), the non-native *hi-koo-ki* is the second element in the compound, *rendaku* does not occur. The behaviour of (4) and (5) is predictable in the sense that voicing does or does not occur depending on whether the second element is a native Japanese word or another type of word formed from Chinese roots. If the second element is a native word, *rendaku* happens but if it is a non-native word it doesn’t. As to why *to-hu* (‘tofu,’ a Chinese loan) does voice in (3) will be pondered further in later sections. For now, let us consider more environments where *rendaku* occurs regularly.

2.2 More compound types: *rendaku* environments

This section provides a summary of environments where *rendaku* is observed. These include subordinating compounds, including those whose second members contain up to three syllables, and intensifying/pluralizing reduplicants. Examples of each type are given in Table 1.

In (6-9) the words for ‘lost,’ ‘young,’ ‘ash,’ and ‘burn/fry’ all respectively modify their second components which in turn make up the lexical head of the compound. Example (10) is

² For a detailed discussion of lexical strata in Japanese, see Ito & Mester (hereafter I&M) (1999).

the same compound as (4) discussed earlier, and the last example (11) is a particular kind of reduplication in Japanese whose function is to either a) express plurality or b) intensify the meaning of the original form.

Table 1

A summary of environments where *rendaku* occurs

Subordinating compounds (I&M, 2003: 86)		
(6)	<i>mai</i> 'lost' + <i>ko</i> 'child'	→ <i>mai+go</i> 'lost child'
(7)	<i>waka</i> 'young' + <i>ha</i> 'leaves'	→ <i>waka+ba</i> 'young leaves'
Compounds with mono- to tri-syllabic 2 nd members (I&M, 2003:74, 75):		
(8)	<i>hai</i> 'ash' + <i>sara</i> 'dish'	→ <i>hai+zara</i> 'ashtray'
(9)	<i>yaki</i> 'burn/fry' + <i>sakana</i> 'fish'	→ <i>yaki+zakana</i> 'broiled fish'
Root+Word compounds (Rosen, 2003:13)		
(10)	<i>hi-koo-ki</i> 'airplane' + <i>kumo</i> 'cloud'	→ <i>hi-koo-ki+gumo</i> 'vapour trail'
Intensive/pluralizing reduplicants (I&M: 76, 77):		
(11)	<i>kata</i> 'person (hon.)' x2	→ <i>kata+gata</i> 'people (hon.)'

Table 2.

A summary of environments where *rendaku* does not occur

Coordinating compounds (I&M, 2003: 86):		
(12)	<i>oya</i> 'parent' + <i>ko</i> 'child'	→ <i>oya+ko</i> 'parent & child'
(13)	<i>eda</i> 'branches' + <i>ha</i> 'leaves'	→ <i>eda+ha</i> 'branches & leaves'
OV (object-verb) compounds (I&M: 86):		
(14)	<i>sakana</i> 'fish' + <i>turi</i> 'catching'	→ <i>sakana+turi</i> 'catching fish'
(15)	<i>kami</i> 'hair' + <i>sori</i> 'shaver'	→ <i>kami+sori</i> 'razor'
Compounds with non-native 2 nd members:		
(16)	<i>kami</i> 'paper' + <i>hi-koo-ki</i> 'airplane'	→ <i>kami+hi-koo-ki</i> 'paper airplane'
(17)	<i>mee</i> 'famous' + <i>kom-bi</i> 'duo'	→ <i>mee+kom-bi</i> 'famous duo'
'Mimetic' (sound-symbolic) reduplicants (I&M: 77 (adapted)):		
(18)	³ <i>*sara</i> '?swishy' + <i>*sara</i> '?swishy'	→ <i>sara+sara</i> 'smooth & silky'
(19)	<i>*kata</i> '?clack' + <i>*kata</i> '?clack'	→ <i>kata+kata</i> 'clackety-clack'

2.3 *Non-rendaku environments*

Table 2 summarizes the types of compounds where we do not see sequential voicing. In contrast to subordinate compounds, coordinate compounds (12, 13) where neither component modifies the other see no voicing. Thus while the subordinately modified 'child' in (4) undergoes voicing to go, it does not voice in (12) when paired with the word for 'parent' in *oya+ko* ('parent and child'). As well, compounds formed from words in an object-verb relationship (14, 15) are not subject to *rendaku*. As seen in Section 2.1, compounds where the second element is a non-native word (16, 17) are (generally) immune. The other similar-yet-different case of non-occurrence is in mimetic reduplicants (18, 19) whose meanings are

³ Similar to Chinese roots, mimetic roots do not grammatically occur on their own.

neither intensified nor pluralized as in (11) but rather are symbolically related to the sounds of the compounded forms themselves.

The other and perhaps best recognized condition in which *rendaku* fails to apply is where the second component of a compound already contains a voiced obstruent within it. Otherwise known as Lyman's Law, this condition trumps sequential voicing even in cases that would otherwise fall into those described in Table 2. Interestingly, Lyman's Law applies even where the voiced obstruent in the second component of the compound is relatively far away from what would have been the target for *rendaku* to apply, as in (21) given in Table 3.

Table 3.

Non-application of *rendaku* due to Lyman's Law (I&M, 2003: 89-90)

Coordinating compounds (I&M, 2003: 86):			
(20)	<i>nama</i> 'raw'	+ <i>kubi</i> 'head'	→ <i>nama+kubi</i> 'freshly severed head'
(21)	<i>kaki</i> 'write'	+ <i>kotoba</i> 'word'	→ <i>kaki+kotoba</i> 'written language'
(22)	<i>tugi</i> 'next'	+ <i>tugi</i> 'next'	→ <i>tugi+tugi</i> 'in succession; one by one'

2.3.1 Lexical immunity, resistance, & prosodic length

Rosen (2003) elaborates on the environments mentioned above by focussing on a number of seemingly inexplicable exceptions to *rendaku* which, he argues, have a great deal of systematicity. From a corpus of roughly 1,500 native Japanese compounds he identifies a small number ($T = < 70$) 'immune' nouns which never undergo voicing (see Table 4). As well, he finds slightly more 'resistant' nouns which voice in only a small number of short (single prosodic word) compounds and regularly in long ones (see below for a discussion of prosody and word size). The majority of *rendaku*-eligible nouns in his corpus, moreover, are words that 'robustly' voice.

Table 4.

Rendaku-immune & -resistant nouns

(Immune)		(Resistant)	
<i>kita</i>	'north'	<i>kuse</i>	'habit'
<i>kasu</i>	'dregs'	<i>kusa</i>	'grass'
<i>hama</i>	'beach'	<i>saki</i>	'tip'
<i>sita</i>	'below'	<i>hara</i>	'field'
<i>tuti</i>	'earth'	<i>te</i>	'hand'
...		...	
Rosen (2003:7-9)			

In terms of prosodic size, he observes that it plays a critical role in determining whether or not 'resisters' voice. Specifically, he argues that long compounds are too big prosodically to be contained in a single prosodic word, which means that within the compound there is a prosodic word boundary: a special position where markedness (i.e. *rendaku*) can be licensed (Rosen, 2003: 20-21). In discussing prosodic units, I adopt the structure (see Fig. 1) assumed

by Rosen (2003) wherein a prosodic word (PWD) dominates maximally two prosodic feet (φ), which in turn dominate from one to two moras (μ). This view of prosodic structure for Japanese diverges from that of Kubozono (1999) in that the syllable is essentially left out. I do, however, go along with Kubozono's observation that, based on evidence from loanword phonotactics and clippings, the PWD in Japanese prefers to be two bi-moraic feet in length.

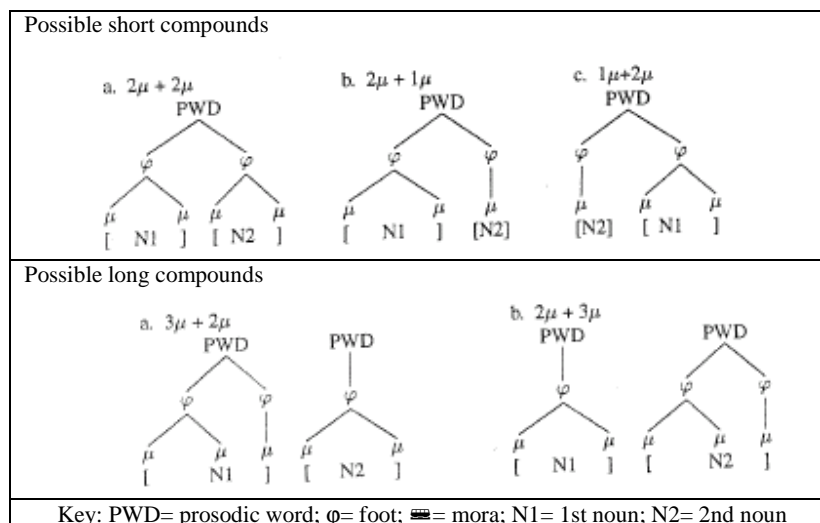

Figure 1.

Structures for 'short' and 'long' compounds (Rosen, 2003:20). While both conjuncts in a short compound are contained by a common PWD, long compounds involve two PWDs. *Rendaku* occurs at the left edge of the rightmost conjunct in the compound.

One structural observation that can be made from the schemata in Figure 1 is that there are at least two prosodic domain boundaries which demarkate where *rendaku* happens. Again, the target for voicing is the initial obstruent of the second, or rightmost element of the compound. In short (one PWD) compounds, this means that the left edge of a foot is involved. Moreover in long (two or more PWD) compounds, the left edge of two domains is involved: the foot, as in short compounds, as well as the larger PWD itself. This observation is intriguing in light of the dual behaviour of 'resistant' nouns which resist voicing in short compounds but yield to it in long compounds. They question raised, then, is whether this duality is rooted in some sort of double-domain edge effect. This as well as other potential explanations are explored from Section 3 below.

3 Possible Explanations

As we have seen in the previous sections, *rendaku* is a voicing phenomenon whereby the first obstruent in the second element of a compound word becomes voiced, barring a number of restrictions discussed above. The first of these limitations has to do with the type of compound: *rendaku* does not occur in bound root compounds, object-verb, or coordinate compounds. Moreover, sound-symbolic mimetic reduplicants do not undergo voicing whereas pluralizing or intensifying reduplicants do. Above and beyond these conditions, the presence of a voiced obstruent in the second component of a compound, even at some distance, trumps *rendaku* irrespective of the type of compound in question. In this way, *rendaku* gives us a puzzle whose solution necessarily makes reference to more than just how sounds arrange themselves in a given string: 1) Morphology delimits what type of words *rendaku* applies to, 2) Phonology plays a role insofar as the process is sensitive to the presence or absence of voiced obstruents in the second component, and 3) Prosodic domains are involved insofar as voicing targets a particular *edge* within a compound.

3.1 Autosegments & ghost morphemes

One solution to the messy problem of accounting for sequential voicing in terms of phonological rules is offered by Ito & Mester (1986, 2003) who avoid this by positing that *rendaku* is itself not a process so much as an actual [+voice] morpheme linking the two elements in a compound (I&M, 2003:83). This ghostly linking morpheme (\mathfrak{R}) is realized on the initial obstruent of the second noun (23) or, if there is already a voiced obstruent in the second component, it surfaces through that segment's [+voice] feature (24). These approaches recast Lyman's Law as a manifestation of the Obligatory Contour Principle (OCP) which operates to heighten perceptual salience by banning sequences of the same feature.

(23) *mai* 'lost' + \mathfrak{R} + *ko* 'child' \rightarrow ^{\mathfrak{R}} *mai+go* 'lost child'

(24) *kaki* 'write' + \mathfrak{R} + *kotoba* 'word' \rightarrow ^{\mathfrak{R}} *kaki+kotoba* 'written language'

There are crucial difficulties with this and similar analyses offered by Fukazawa & Kitahara (F&K) (2001) and Rosen (2003). Both I&M and F&K do not account for a large number of idiosyncratic exceptions to sequential voicing such as the immune and resistant nouns discussed earlier. Although Rosen (2003) does account for such exceptions, the complexity of his analysis and its dependence upon adjusting floating versus linked feature values in the input to suit the output leaves much to be desired. The question follows, however, as to whether there are any better explanations for the phenomenon.

3.2 Whence the ghost may have come: a diachronic view

Unger (1993; 1975, in I&M, 2003) offers a historical analysis which both explains possibly why *rendaku* does not apply to object-verb or coordinating compounds, as well as provides circumstantial evidence for the existence of a phonetically empty [+voice] linking morpheme. It happens that two grammatical particles, the genitive *-no* and the oblique *-ni*, may have left ghosts of themselves in the form of post-nasal voicing. That is, many present-day subordinate compounds can be traced to phrasal antecedents involving either particle.

Table 5 depicts the development of one such compound, ‘a woman’s heart.’ Insofar as grammatical particles used in the phrasal counterparts of coordinate and object-verb compounds have no nasal, it stands to reason that there would be not ghost of post-nasal voicing in them. Although Unger’s account is intriguing on an explanatory level, it still does not tell us why *rendaku* typically fails to occur in Sino-Japanese root compounds which, after all, are used in analogous phrasal environments.

Table 5.

Diachronic change with the genitive particle *-no* (Adapted from I&M 2003:86)

	(Genitive Phrase)	(Process)
↓ Passage of Time ↓	<i>onna+</i> no # <i>kokoro</i> woman+ GEN# heart ‘the heart of a woman’	Loss of vowel from <i>-no</i> leaves a bare nasal.
	<i>onna-</i> n # <i>gokoro</i> woman- GEN# heart ‘the heart of a woman’	-no → -n, k → g Post-nasal voicing targets [k] in <i>kokoro</i> .
	<i>onna+</i> <i>gokoro</i> woman+ heart ‘a woman’s heart’	-n → ∅ Loss of remaining nasal, but voicing effect sticks.
	(Subordinate Compound)	

3.3 Functional possibilities

From Gordon’s (2005) work on perceptual salience in syllable onsets, Martel (2009) proposes the terms *striping* and *counter-striping* to characterise the increasing (*striping*) or decreasing (*counter-striping*) of perceptual salience at the edge of a given phonological domain (p. 3). Given that compound words inherently involve the bringing together of two or more psychologically meaningful units, it is reasonable to imagine that a language would employ strategies such that the relatedness of the compounded elements were easily recognizable. That is, insofar as the voicing of an onset obstruent decreases perceptual salience (Gordon, 2005), *rendaku* may be a means of counter-striping one component so as to more easily allow for the entire compound to be perceived as a single unit.

The question remains, though, as to why would Rosen’s immune nouns never voice and the resistant ones voice only in long compounds. If we hold to the premise that a PWD containing two bimoraic feet is the favoured shape of a word in Japanese, we can designate

the single PWD span as the ‘default’ psychologically meaningful unit. That is to say, when speakers of the language hear a chunk of four moras, they would expect it to be a single word (both prosodically and morphologically). Assuming this perceptual bias toward parsing 4-mora spans as single words, we can make the functional argument that, in order to preserve some sign that the span is in fact made up of two parts, increased perceptual salience is needed. In other words, then, short compounds use striping to maintain the perceptual integrity of either component by retaining a maximally salient (i.e. voiceless) sound at the left edge of the second prosodic foot.

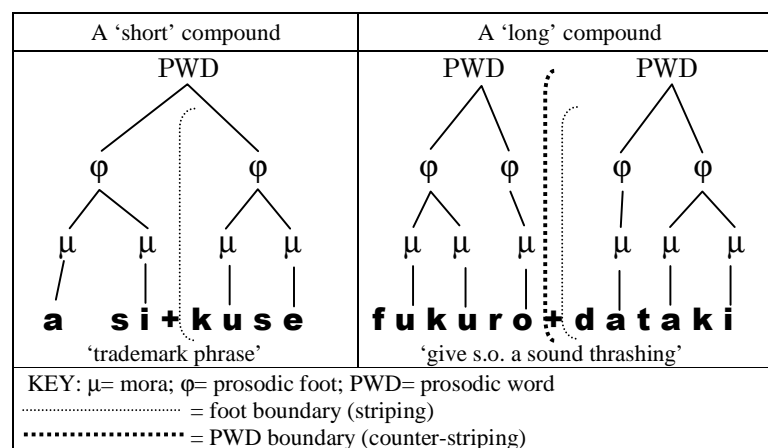

Figure 2.

Prosodic structure & boundary effects. Foot boundaries serve as loci for striping while PWD boundaries are loci for counter-striping.

Conversely with long compounds which are inherently more than one PWD, there is no need to remind speakers that the chunk that they are dealing with is more than 4-moras in length. In fact, the opposite may be argued: that, in order to signal the psychological unity of a long compound, perceptual salience is reduced at the PWD boundary. In other words, long compounds use counter-striping to heighten the relatedness of its conjuncts while short ones employ striping to achieve the opposite. Both of these conditions are illustrated in Figure 2.

3.3.1 Hot tofu & other unpalatables

The preceding line of reasoning with regard to the role of perceptual salience at different prosodic boundaries is well worth pursuing in future studies of *rendaku*, but there are nonetheless some facts that are still mysterious. Recall the case of (3) *yu+do-hu* (‘hot tofu’), where *do-hu* is a Chinese root compound which we would not expect to undergo voicing. That is, in spite of its not being a native Japanese word it nonetheless behaves as though it were. In a similar pot but with slightly different broth is (1) *kuchi+guse* (‘trademark phrase’). Prosodically speaking this is the ideal shape we would expect for a word in Japanese: a single

PWD formed from two bimoraic feet. However, sequential voicing occurs counter to the argument in Section 3.3 which predicted that the prosodic foot boundary in a short compound would be a locus for striping so as to bolster the integrity of the second component.

Although autosegmentalists such as Rosen (2003) successfully account for these idiosyncrasies through deft manipulation of featural specifications in the lexicon, a more explanatorily satisfying possibility is offered by Pierrehumbert (2001). Here she proposes a model, Exemplar Dynamics, in which phonological processes such as lenition become more pervasive in forms which are used more frequently. Considering that *tofu* has been very much apart of Japanese language and culture for centuries, this is a tantalizing explanation for why *to-hu* might voice in *yu+do-hu*. Also, a similar argument can be made for the voicing of *kuse* in *kuchi+guse* ('trademark phrase'). Compared with its cousin compound *asi+kuse* ('way of walking'), *kuchi+guse* certainly has a more abstracted meaning which may be indicative of a higher rate of occurrence. That said, however, these observations serve only to highlight issues and areas where further research is needed.

4 Discussion & conclusions

Unger's diachronic explanation of the possible origins of *rendaku* as being a remnant of phrasal truncation and post-nasal voicing assimilation is an intriguing one. This suggests the possibility that historical processes in a language cast ghostly shadows onto the present, and that those shadows (as linking morphemes, floating features, or any other similarly abstract creature) surface in the grammar in predictable ways. That said, however, we have seen that predictability in *rendaku* is largely a conglomeration of tendencies. Lyman's Law/OCP exceptions to voicing are highly predictable, but the situation becomes less sure as we attempt generalizations based on lexical strata (native vs. loanwords), or prosodic structure (foot vs. PWD boundary effects). Nonetheless, the argument that sequential voicing (or non-voicing) may be conditioned by the need to augment or decrease perceptual salience is more explanatorily satisfying than any appeal to linked versus unlinked floating features swimming in the turbid pool that is the lexicon. However, just as the autosegmental accounts require us to stretch our imaginations to accept abstract invisible elements as real, the perceptual salience account in §3.3 does not explain idiosyncratic exceptions well. As such, we are left to ascribing any idiosyncratic phenomena to Exemplar Dynamics and the effects of frequency. In other words, we still are required to take a leap of faith.

So where does this leave us? Having begun to investigate how the edges of prosodic feet and prosodic words may potentially influence if and when voicing occurs, the next step is to quantitatively analyze this process in greater detail. As well, diachronic studies of frequency, and 'age' of loanwords where we do see *rendaku* occur are needed to verify the predictions of Exemplar Dynamics. Until such work progresses, though, we are left with an understanding of compound voicing which is invariably haunted by conjecture.

References

- Fukazawa, H., & Kitahara, M. (2001). Domain-relative faithfulness and the OCP: Rendaku revisited. In Van de Weijer, J. Maarten, & T. Nishihara (Eds.), *Issues in Japanese Phonology and Morphology*. New York: Mouton de Gruyter, 85-109.
- Gordon, M. (2005). A perceptually-driven account of onset-sensitive stress. *Natural Language & Linguistic Theory* 23, 595-653.
- Ito, J. & Mester, A. (1986). The phonology of voiceing in Japanese. *Linguistic Inquiry* 17, 49-73.
- Ito, J. & Mester, A. (1999). The Phonological Lexicon. In John McCarthy (ed.), *Optimality Theory in Phonology: A Reader*. Cambridge: Blackwell. [Excerpt from: Natsuko Tsujimura (ed.), *The Handbook of Japanese Linguistics*. Oxford: Blackwell, 62-100.]
- Ito, J. & Mester, A. (2003). *Japanese Morphophonemics: Markedness and Word Structure*. Cambridge, MA: MIT Press, 71-99.
- Kubozono, H. (1999). Mora and syllable. In: Natsuko Tsujimura (ed.), *The Handbook of Japanese Linguistics*. Oxford: Blackwell, 31-61.
- Martel, J. (2009). A Functional Account of Phonological Processes at the Edges of Phonological Domains. *Working Papers of the Linguistics Circle* 19.
- Pierrehumbert, J. (2001). Exemplar dynamics: Word frequency, lenition, and contrast. In J. Bybee & P. Hopper (Eds.), *Frequency and the Emergence of Linguistic Structure*. Amsterdam: Benjamins, 137-157.
- Rosen, E. (2003). Systematic irregularity in Japanese rendaku: How the grammar mediates patterned lexical exceptions. *Canadian Journal of Linguistics/Revue canadienne de linguistique* 48 (1/2), 1-37.
- Unger, J.M. (1975). *Studies in Early Japanese Morphophonemics*. Doctoral dissertation. Yale University. In: Ito, J. & Mester, A. (2003). *Japanese Morphophonemics: Markedness and Word Structure*. Cambridge, MA: MIT Press.
- Unger, J.M. (1993). *Studies in Early Japanese Morphophonemics*. (Second Edition). Bloomington, IN: Indiana University Linguistics Club Publications.

Frequency, Phonology, the Brain, and Second Language Acquisition: Laying the Ground Work for a Hybrid Approach

Scott Moisik

Department of Linguistics, University of Victoria

srmoisik@uvic.ca

ABSTRACT

A hybrid theory of second language acquisition is presented, which integrates postulates of Flege's (1992, 1995, 2003; Flege et al. 2003) Speech Learning Model and Bybee's (2001) proposals for Usage Based Grammar. As this proposal deviates from the Generative program, which does not permit frequency as an explanatory factor, a review is given of major currents in the literature concerning frequency in phonology and theories which incorporate frequency and patterns of distribution in phonological systems. The conclusion drawn from this review is that frequency is one of many performance factors worth considering as an explanatory factor in theories of phonology. The hybrid model is discussed and extended to a problem in second language acquisition of German by native English speakers. The SLM predicts that learners will not be able to establish a sound category for German dark-schwa, a sound which is remarkably *similar* to English schwa. A previous study shows that this is not only possible, but a production difference between the two German schwas was documented for relatively inexperienced speakers of the language. The hybrid model accounts for this exception to the SLM by appealing to the fact that the contrast between schwa and dark schwa in German is highly frequent.

Keywords: frequency; psycholinguistics; connectionism; emergentism; L2; German; dark-schwa; phonology; phonetics;

1 Introduction

The current 'received view' of linguistic research is the Generative model, which denies *performance* factors an explanatory role. While hybrid fields like psycholinguistics and neurolinguistics have already pushed deep into the frontiers of the brain and language processing, the traditional generative approach is still the predominant framework in which new linguists are trained and the context of mainstream linguistic research. Frequency represents one of many performance factors that have been systematically ruled-out of the generative paradigm in the interest of pursuing grammatical purity in the form of linguistic competence. The papers reviewed in this article strongly suggest otherwise; that by ignoring performance factors we risk distorting our view of language, placing it in a context isolated from everyday use and fluency. Frequency is central to this theoretical debate (e.g. Bybee & Hopper 2001; Ellis 2002) because of its salience as a concept for us. It relates directly to

statistics and probability, both conceptual tools that are intuitive. It also is manifestly measurable; all one has to do is count. But the pith of this discussion is not to assert that frequency is the panacea to all of our linguistic woes. Rather, it is the starting point, or thread into a larger discussion concerning the future of mainstream linguistic research in a format that is "biologically, developmentally and ecologically plausible" (Ellis 1998: 640).

Although extensive research exists on the topic of how frequency impacts linguistic phenomena such as phonological representation (Frish 1996; Zuraw 2000), parsing (MacDonald 1994; Nimmo & Roodenrys 2002), phonotactics (Bybee 2001), first language acquisition (Curtin 2002; Nicoladis & Yin 2002), and the definition of language universals (Greenberg 1966), the generative framework has not acknowledged its explanatory role in linguistic research for the past forty years (Vihman 1996: 15-49; Ellis 2002: 175-77). Behaviorists conducted some of the early work on demonstrating a link between frequency and language. These theories lost favor in the domain of linguistics, however, when Chomsky published his 1957 critique of Skinner's *Verbal Behavior* (1957). This precipitated linguistic research with a focus on linguistic competence (Chomsky 1965) rather than performance or language use, a trend that is still prominent in the field. Today, with the increasing integration of linguistically oriented studies in cognitive (Langacker 1988), neurological, and computational programs, there has been a renewed interest in frequency and its effect on language (Ellis 1998). Of particular importance is the emergentist framework (Elman et al. 1996; MacWhinney 1998; Elman 1999); it has provided a theoretical foundation that integrates the concept of frequency among other neuro-cognitive and environmental factors which give rise to linguistic behavior. Emergentism, among other related contemporary frameworks such as connectionism, stands in stark contrast to the nativist program that has developed in tandem with Chomsky's Universal Grammar and Minimalist program (Cook 1988; Chomsky 1995). The perennial debate of *nature versus nurture* is once again raised by these opposed theoretical views. It should be noted, however, that the viewpoints contrast in how language is innate, rather than whether language is an exclusively internal or external phenomenon to the individual that engages in linguistic behavior (as far as the behaviorists were concerned: Watson 1924). The generative program is clearly aligned against the utility of linguistic performance facts as a means to obtain information about how language is represented. Their contention is that only by assessing linguistic competence do we learn about language in mind (Chomsky 1965). As we shall see, performance holds much more worth in models that afford frequency a role in explanation of linguistic phenomena. The ultimate goal of this paper is to present a selection of contemporary research being done that is reshaping the way that linguists think about language and contributing to a gradual paradigm shift (Ellis 1998, 2002) towards linguistic research that exhibits cognitive, neurological, ecological, and contextual validity.

2 The role of frequency

In two recent publications by Ellis (1998, 2001), concerns about the theoretical adequacy of the generative tradition are raised. The primary criticism is that generative linguistics has become hermetically preoccupied with the search for grammatical competence and in the process has ignored matters of "semantics, the functions of language, social, biological, experiential, cognitive aspects, [...] lexis, fluency, idiomaticity, pragmatics and

discourse" (Ellis 1998: 634). Ellis is not a maverick in expressing these concerns either; Langacker (1988: 128) claims that excluding performance data severs the linguist from the very medium she is studying, severely jeopardizing the psychological validity of the research. Allen & Seidenberg (1999: 115-9) argue that, as a result of the competence-performance dichotomy, generative grammars have fatally limited their ability to explain linguistic phenomena. The main reasoning of their argument is that competence grammars are too abstract to be clearly related to performance factors (viz. Chomsky 1995: 380) and too exclusive of performance factors (such as memory capacity, perceptual and motor systems, and statistical information) to be cognitively, or neurologically valid. Ironically, however, it can be argued that the generalizations of competence grammars are never-the-less determined by metalinguistic judgments of speakers, which are known to be impacted by performance factors. Hopper (1987) asserts that language is not a static system uninfluenced by its day-to-day usage; Harris (1990) echoes the concern of treating language as a set of *a priori* conditions and ignoring the context and function associated with language. Elman (1999; Elman et al. 1996) along with neurobiologists (Ellis 1998) criticize generative grammar and UG for lacking plausibility in a neurological context, both in terms of inheritance and function. Pierrehumbert (2002) argues that statistical information (a matter of token frequency) about patterns can be viably associated with abstract phonological variables (such as morae and syllables). She asserts that statistical information allows us to "reach important conclusions about the nature of human language, conclusions that would elude us in a nonprobabilistic framework" (Pierrehumber 2002: 2). Such conclusions evidently tell us about the non-uniformity of phonological processes both diachronically and synchronically.

Ellis affords a large explanatory role to frequency; of particular interest here is the role frequency plays in phonology and phonotactics. Evidence from Frish et al. (2001) is raised to show how phonotactic judgements correlate with the frequency of a given phonotactic pattern; similar results are observed in Bybee (2001): judgments of word-likeness assigned by native speakers to nonce syllables correlate with the frequency of the phonotactic pattern in English, even when no phonotactic constraints are violated. Even more surprising is that nonce words with illegal syllable structure are regarded as more well-formed than nonce words with licit syllables that are infrequent, especially if the former contains a frequent suffix like *-ation* (c.f. /m.u'pejfn/ with /spletsak/: see Coleman & Pierrehumbert 1997). Similar findings are demonstrated in infants (Jusczyk et al. 1994). The general claim is that humans possess the ability to perform distributional analyses on input stimuli; Ellis notes that this ability "is to be found in the plasticity of synaptic connections rather than abacuses or registers, but it constitutes counting nevertheless" (2001: 146). Thus, our sensitivity to the distributional patterns is not conscious, nor linguistic, but rather a property of our neurological organization. Even more tell-tale is the fact that numerous studies reported on by Ellis demonstrate an infant's ability to rapidly process distributional information. In a syllable segmenting study by Saffran et al. (1996) infants exposed to an unbroken stream of syllables were sensitive to trisyllable groups that appeared as a unit given their increased frequency. Segmentation studies also document the importance of frequency in discovering the edges of linguistic units in an unbroken stream (e.g. Saffran et al. 1999). Beyond this, Ellis observes that humans are sensitive to distributional patterns on multiple planes, as we can integrate statistical information for multiple cues for word segmentation (Christiansen et al. 1998). In speech comprehension, comprehension is impeded when a low-frequency word must compete with high-frequency neighbors for activation (Lively et al. 1994).

Bybee (2001) presents several cases of diachronic phonological change that is explainable in terms of frequency. One of these processes is variable word-medial schwa-deletion in English. For example, common words like *every* are regularly pronounced without a medial schwa or its associated syllable slot (i.e. [ɛv.i]). Mid-frequency words, such as *memory*, occur with a syllabic /r/, and rare words like *mammary* are produced with both a schwa and an /r/. Blevins (2004) proposes a model of diachronic sound change that incorporates frequency as a vital component. The model assumes that language change results from the discontinuous transmission and non-homogeneity of linguistic structure from person-to-person and generation-to-generation. Specifically, each speaker lexically encodes the phonetic variability of their language; language users determine the phonological form of words by the relative frequency of various competing phonetic forms (Blevins 2004: 41).

Pierrehumbert's Exemplar Dynamics (2001) and Probabilistic Phonology (2002) models are both built upon the assumption that phonological form is in part determined by the relative frequency of ambient phonetic tokens. In exemplar dynamics, phonetic variation for a given form (a phoneme or a word) is encoded into a cluster of the variants or exemplars encountered over the language user's lifetime. Thus, the relative frequencies of phonetic variants play a large role in shaping the content of the exemplar clusters. The resulting model is used to explain fine-grained phonetic patterns, the incremental changes observed in a language user's phonological patterns, and a diachronic class of sound changes involving lenition (such as the *every-memory-mammary* change cited above). Probabilistic Phonology is an attempt to render phonology more tractable to the observation that phonetic categories vary continuously and organically. This goes against the traditional generative assumption that phonologies are "(radically) underspecified" (Roca 1994: 53-62); in statistical models of language, the phoneme and lexical items contain "redundant and detailed" (Bybee 2001: 40) information. The correspondent of the phoneme in Probabilistic Phonology is the phonetic category, which is the locus of frequent linguistic output; the region which has the highest probability of being actually implemented by a given language. Pierrehumbert employs this model to discuss limitations on the language learner's ability to make inferences about phonetic categories as well as phonological constraints. The receptive vocabulary size and the volume of speech encountered on a day-to-day basis impact the distribution of the cues to these linguistic structures. The model provides an explanation for why vowel inventories do not exploit the entire acoustic space; probabilistically determined overlap among vowel tokens reduces the discriminability of the system. Without gaps in the overall system - areas of low probability of vowel occurrence - the language would suffer from low discriminability.

Recently, facts of frequency have begun to appear in generative models and, while it is not explored fully here, it is worth noting. The traditional application of constraints in Optimality Theory (OT: Prince & Smolensky 1993) is categorical; constraint ranking is said to be held in a strict dominance formation. In this model, it is possible for constraints to be unranked with respects to one another, but in this does not conflict with strict dominance, rather it merely conflates the constraints. However, as proposed and employed in (Frish 1996; Hayes and MacEachern 1998; Boersma 1998; Boersma & Hayes 1999; Zuraw 2000; Escudero 2006), stochastic constraint ranking has been explored as a possible avenue of accounting for variability in output forms. In this model of constraint interaction, probability distributions define the likelihood of constraints being assigned a particular ranking in the grammar. At each attempted production, the grammar randomly selects a point in the ranking hierarchy to insert the constraint; crucially, this insertion point is constrained by the ranking's

probability distribution. Hayes and MacEachern (1998: 48) claim that stochastic ranking predicts both output candidates in a similar fashion to classic OT, and allows predictions about output frequencies to be determined¹. Thus, it would appear that the importance of frequency and related phenomena such as probability distributions are beginning to be re-acknowledged even by the presiding paradigm of linguistic research - the generative approach.

3 Theories that acknowledge frequency

The theories of language that incorporate frequency as an explanatory factor reviewed in this section notably reject the nativist hypothesis that linguistic structure is innate or hard-wired. This is one of the firmly entrenched assumptions that generative grammars make: despite the putative *poverty of the stimulus*, languages are learnable, because the principles and parameters of language are hard-wired into the brain. Thus, acquiring the grammatical structure of a language is a matter of finding evidence in the input for the parameter settings it employs. Or as Chomsky himself put it:

A consideration of the character of the grammar that is acquired, the degenerate quality and narrowly limited extent of the available data, the striking uniformity of the resulting grammars, and their independence of intelligence, motivation, and emotional state, over wide ranges of variation, leave little hope that much of the structure of the language can be learned by an organism initially unformed as to its general structure. (Chomsky 1965: 58)

The primary directive of generative grammars is implicit in the above passage: to understand the universal apparatus by which language acquisition is possible. Since the apparatus, referred to as Universal Grammar (UG), is robust enough to compensate for the poor sampling of language a prelinguistic child receives, frequency, among other factors is irrelevant to the linguists agenda. We shall see that the new approaches view language innateness in a radically different fashion.

Langacker's conception of grammar is formulated within the more general framework of Cognitive Linguistics (Rudzhka-Ostyn 1988), which pays heed to the psychological and cognitive environment that language occupies. The proposal in Langacker (1988) is for a usage-based model that incorporates frequency *ipso facto*: language is stored and represented as a "massive, highly redundant inventory of conventional units" (1988: 131). Unifying these units of linguistic storage are *schemas*, representations of linguistic patterns that emerge from the use of language through exposure and production. The statistical and distributional facts of language contribute to the influence that these schemas have on the grammar as a whole, and from speaker to speaker the grammar can exhibit variations that reflect the idiosyncratic linguistic experience of its user (1988: 130). The core tenets of usage-based grammar are diametrically opposed to those of generative grammar. In the later, grammars are assumed to be economically constructed sets of rules that generate the output of the grammar from a given input, and in this sense they are generative. Any information that is predictable is not listed in the grammar as it can be derived via linguistic rules. Langacker's usage-based grammar is described as "maximalist, non-reductive, and bottom-up" (1988: 131). Predictable details are stored in the grammar in addition to overarching patterns (which are referred to as schemas by Langacker). Thus, grammars are bottom-up in

¹ For further details on this matter the reader is encouraged to consult the original resource.

that the emphasis is on the details of linguistic forms rather than the rules that derive the forms. This reconception of grammar allows insight into the formation of grammatical principles/schemas. Instead of being a predetermined component of the linguistic system that becomes parameterized based on the ambient language, the language data gives rise to the pattern's extent in the grammar. Most relevant is the possibility for these patterns to encode frequency of the pattern by virtue of the number of tokens of a particular pattern that are encountered by the language user.

Bybee (2001) is taken to be representative of the basic outline of a usage-based grammar. She explores how the usage-based grammar is employed in the domain of phonology, and it will be useful to consider this aspect of her discussion. Six principles are described that characterize usage-based grammar; they are as follows. The first principle states that language experience impacts the way language is represented. One of the more important experiential effects is that of frequency: there is a tendency for higher frequency items to be represented more strongly. Strength is manifest in both accessibility of the form and the resistance to diachronic processes. The second principle is that language is not a modular system entirely distinct from other cognitive processes. As a consequence, there is no need in the system for predictable properties of language units (such as phonological representations) to be stripped away; the mind is capable of detailed storage. Thirdly, it is assumed that categorization is based on identity or similarity and that categorization of linguistic units operates in a manner analogous to other perceptual systems (such as vision). The fourth principle is that generalizations and patterns emerge from actual stored linguistic data in a manner similar to Langacker's (1988) schemas. Productivity of the grammar is described as a process of reference to existing forms; however, storage units can contain words that are fully inflected (i.e. /kæt + -s/ can be stored as /kæts/. The fifth principle advances Langacker's (1988) assumption that the grammar is redundant. In Bybee's model the grammar stores information at multiple levels of abstraction producing a highly redundant lexicon. The units of organization emerge from similarity across tokens and can be thought of in terms of traditional phonological units such as the syllable. The sixth and final principle is that phonology is assumed to be a form of procedural knowledge. This affords phonology a role in the production and decoding of linguistic constructions. An important implication of this idea is that phonology is thought to be learned in sets of procedural routines. These routines are categorizable and can be recruited in the production of similar words. As the degree of language use increases, the more the routines become automated and have the potential to reduce in form.

In usage-based models, principles of grammar are assumed to be created by and continually shaped through language use. Thus, there is no requirement for grammars to be prespecified for linguistic structure before the individual starts encountering language. Moreover, there is no disjunction between language and other cognitive functions, thus language can only be as 'prewired' as the entire cognitive apparatus. The question of innateness, however, still stands. Many questions are left unanswered by usage-based approaches with regards to how classification of linguistic units is carried out, or even begins for that matter. At times, a usage-based grammar will refer to structures being emergent. This is meant to describe a system where similarity in form gives rise to a generalization or abstraction over that form. Crucially, this is distinct from the nativist conception that the forms themselves are prewired and filter the perception of linguistic stimuli. The emergentist

framework of language directly addresses the question of innateness, and thus will now be discussed.

Emergentism portrays language as a system in flux; it is fluid and adaptive; ultimately it is a system that has "structures [that] are unstable and manifested stochastically" (Bybee & Hopper 2001). Before a fruitful discussion of emergentism can be given, the issue of innateness must first be dealt with. Elman (1999) advances a taxonomy of innateness that contains three major divisions: representational innateness, architectural innateness, and chronotopic innateness. The goal of his analysis is to dispel the nebulous conception of innateness that has been perpetuated in previous literature (c.f. Pinker 1994). The first type, representational innateness, essentially embodies the traditional, generative perspective on the subject. Cognitive representations consist of patterns of synaptic connectivity; it is conceivable that the human genome could encode these patterns, and consequently linguistic principles and parameters. Studies on the genetic contribution to cortical development in humans and higher vertebrates indicate that plasticity, and not predetermination, is the nature of the mechanism (e.g. cortical plug transplants in vertebrates: O'Leary 1989). The consensus is that genes do not transparently contribute to complex behavioral patterns, even in organisms of a lower order of cortical complexity, such as the fruit fly (Greenspan 1995). Thus, Elman rejects representational innateness and along with it, the nativist hypothesis. The second type of innateness refers to the architectural constraints on neurons and neurological connections; for example, neuron firing threshold, neural interconnectivity, or macroscopic level connection amongst neural groupings. The third type of innateness is a matter of how developmental events are sequenced temporally. While this type of innate constraint on language is partly genetic in origin- genes set the gross schedule of neurological development -external factors play a role as well (Elman 1999: 5).

Thus, it is important to observe that emergentism does not dispense with innateness altogether. Rather, innateness is vastly reconceived, from its previous role as pre-specification of linguistic structure in order to bootstrap the learning process. Rather, grammar in emergentism is created through a conspiracy or confluence of forces acting on the individual. Two of these forces are the 'innate' or biologically determined constraints of neural architecture and developmental sequencing. The nature of the perceptual system and the form and distribution of tokens in the external stimuli constitute other factors that contribute to the emergence of language.

To demonstrate his claims, Elman (1993) presents a neural network simulation of L1 acquisition.² The overall task for the network was to correctly predict sequential dependencies in sentence strings. Part of this goal then required that the model assign syntactic categories to the input it received. The model was capable of being specified for how many words it could process at a given time, essentially simulating a 'working memory'. Affording the model a large working memory at the outset yielded mediocre results on the prediction task. However, imposing a developmental sequence on the model, where the size of working memory increased gradually over the training to handle more and more words at a time, yielded a vast improvement on the task. Elman concludes from this that by constraining

² This network begins with a series of network nodes (representing neurons) in layers; connections can be formed across layers and the weighting (overall activation level) of these connections is influenced by the frequency of a particular input (see Nadel et al. 1989). Initially, all the weightings are randomly set so the network has no internal structure. Exposure to input allows the model to readjust weightings according to the types of patterns it is exposed to. These patterns can then be analyzed to identify what the model 'learned'.

the problem space, that is, by starting off with small chunks of grammar and gradually increasing the size of sentences that are analyzed, the learning task was made tractable. From this, Elman reasons that the very reason why a child is a successful language acquirer is not because she is endowed with preconfigured knowledge of grammar in the form of a Language Acquisition Device that later atrophies, but rather because their cognitive capacity initially allows them to process only small chunks of language.

4 Phonology in the brain

In an attempt to understand phonology from a neurologically and cognitively valid perspective, researchers must ask questions about the realization of phonological representations in the brain. The connectionist/emergentist approach assumes that phonology is the result of an emergent set of representations mediating between perceptual and production components of the brain and the storage of semantic representations (e.g. Langacker 1988). Critically, the distribution of phonological data an individual encounters in their lifetime influences the structure of phonological representations. Thus, the content of representations includes redundant, predictable information and the frequency of variation in form is implicitly recorded by means of exemplar cluster density.

Bybee (2001) offers a conceptual reanalysis of the phoneme in light of current and previous research into perception and encoding of phonological units. The canonical approach to the psychological organization of phonemic units is that they have distinct boundaries and are categorically perceived. One criticism of this approach Bybee raises, is that often the underlying specification of phonemes is arbitrary, particularly where there are no morphological alterations to determine which phoneme ought to be used. An example of this is the problem with flaps in words like *butter* and *ladder*, or whether stops in /sC/ clusters are underlyingly voiced or voiceless. Another approach is to allow redundant and detailed information to characterize phonological representations. This assumption works hand-in-hand with the idea of exemplar dynamics (see Pierrehumber 2001) and provides the basis for a radical reconceptualization of the phoneme in a neurological context. As figure 1.0 shows, the phoneme is conceived of as a series of tokens distributed over a region in perceptual space. In this exemplar cluster representation, font size is used to represent the relative frequency of tokens in the phonemic clustering. In the case of English apical-alveolar consonants, the flap is represented as shared region in perceptual space between the /t/ and /d/ phonemes. Rather than discrete phonemic categories, Bybee argues for a phonological system built up of phonetic categories that store the set of exemplars representing that category. In this model, phonetic categories can be associated on multiple dimensions with other phonetic categories and non-phonetic categories such as context of use. The main problem is identifying how such a model can be realized neurologically.

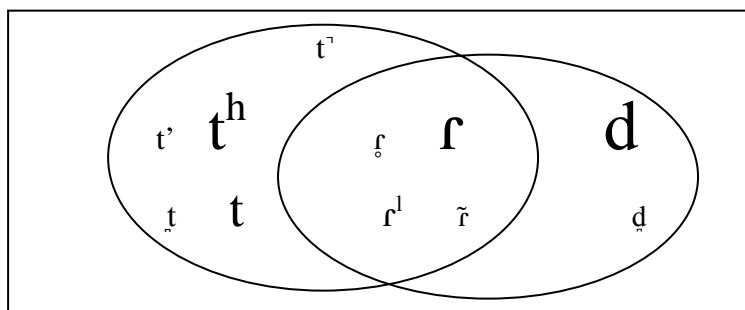

Figure 1.0 Schematic of overlapping exemplar cluster representation of phonetic categories for English apical-alveolar consonants; frequency and consequently representational strength is represented by font size: larger font indicates stronger representation/greater number of tokens (inspired by Bybee 2001; Pierrehumbert 2001).

On the level of neural mapping of phonetic categories, Guenther & Gjaja (1996) demonstrated, through a neural network simulation, how auditory neural organization is dependent, in part, on the rate of occurrence of sounds in the individual's linguistic input. The assumption is that input stimuli is not stored specifically, but rather modifies the weighting of synaptic firing and does not hinge upon token labels or prewired knowledge of phonetic categories. Exposure to native language sound distributions generates non-uniformities in the firing patterns of neurological auditory units, providing a means to explain how infant perception gradually becomes categorical as more stimuli are encountered.

Neuroscience has provided us with a working knowledge of neurological organization, consisting primarily of neurons and the synapses they form with other neurons. While it is often claimed that psychology (and subordinately the subject of language in mind) should be free of neurological speculation because it is far too complex, connectionists argue that the task is made tractable through simulation of neurological architecture (Nadel et al. 1989). These models are structured on connective atoms, neuron-like processing units, intended to represent the neuron and its architecture as closely as possible. The use of these simulations offers insight into how a subsymbolic system (Smolensky 1997) might achieve symbolic representation through the use of connectives that can only interface mathematically with each other. Furthermore, these systems simulate rule-like behavior without being constructed on a rule framework (Ellis 1998: 638). While the topic of how neural network simulations function is important, focus will be placed on the findings of a number of these systems with respects to language, and more specifically phonology.

Allen & Seidenberg (1999) train a neural network to create connections between input forms (words) and their corresponding meaning (word-level semantic representations) to simulate comprehension. In addition, the converse mapping (i.e. meaning-to-form) is also implemented so that the network can produce utterances given an input meaning. By analyzing the pattern of network vector activation at the semantic layer of nodes, an assessment of its ability to comprehend words is demonstrated; performance on sentence comprehension is measured by comparing word level accuracy across an utterance. Similar tests were performed on its production abilities. Both tests reveal that the network was capable of dealing with novel utterances based on a limited training corpus. In addition, they provide evidence that the network possesses the ability to form grammaticality judgments, a

metalinguistic ability, by means of a feedback loop between comprehension-level connections and production-level ones configured during training. Statistically significant behavior in network node activation is observed when novel ungrammatical sentences are presented to the network. As a whole, the network represents a dramatic demonstration of how patterns of grammaticality can emerge in a system made of simple connective units. Prewiring is not required to determine the pattern of connectivity; rather corpus distributions are sufficient to allow the network to identify patterns in the data.

Plaut & Kello (1999) discuss a neural network model of phonological development in the framework of emergentism. The authors seek to model how an infant surmounts the problems of phonetic variability and semantic arbitrariness to arrive at phonological representations of lexical items. The primitives of phonological and lexical structure are distributed throughout the system and, as acquisition takes place, emerge due to similarity in form of the input tokens. Thus, the phonological system, in their model, is presented as a tripartite link between acoustic input, semantic representations, and articulatory mechanisms. Phonological links to semantic representations emerge from repeated exposure to ephemeral acoustic input. Thus, the phonology serves as the memory required to map acoustic input onto semantic content in language comprehension; activation is persistent from one segment to the next as the acoustic input unfolds, until a semantic target is finally converged upon. The authors demonstrate how the model can both be said to have acquired a phonology that enables comprehension and production. This is done by analyzing the type of network connections that are formed across units representing various components of the model, such as that between acoustics and semantics. The extent to which the connections parallel the predetermined relationship between an acoustic form and its semantic feature bundle indicates whether the model converged upon the correct phonological representation. It is crucial to remember that the connections among nodes in the network are impacted by the distribution of forms in the input. While this model does not show how phonological patterns can be generalized to new forms, largely because there is no attempt to represent morphology, it is illustrative of how phonology must use frequency distributions to operate in a noisy system without any prewiring to aid it.

A final example of a neural network simulation applied to language comes from Elman (1990). The network is trained on a sequence of 'phonemes' (their orthographic counterpart) and tasked with predicting the next phoneme in a sequence when given an unfamiliar input string. By virtue of building and weighting network connections to represent the statistical dependencies observed in the training corpus, the network was able to perform the task with a relatively high degree of accuracy. Performance would initially be poor with the first segment, but gradually increase as more segments were encountered. When the incorrect activation pattern for a particular segment was made, often the network would still have activated the correct category of the segment (e.g. whether it was a consonant or a vowel). While this model is relatively simplistic (it is an early neural network simulation: c.f. Vihman 1996), it does offer insight into how simple phonological patterns, such as syllable structure, can emerge from mere exposure to a large corpus of data.

In summary, there is a rich body of research into the representability of language from a neurological perspective, assuming that language principles are not hard wired into the brain at birth. The models themselves are incredibly simple- they are only specified for a basic architecture of node layers- yet are still capable of performing complex linguistic tasks such as making grammaticality judgments. The lesson obtained from these results is that

language does necessarily require innate representations in order to be a tractable object to represent neurologically. What is required is exposure to massive amounts of data and a system that is sensitive to the frequency distribution of forms in the input and capable of recording these patterns. The reader is encouraged to consult Ellis (1998) for further demonstrations of neural networks performing linguistic tasks.

5 Frequency & language acquisition/learning

In the emergentist/usage-based framework, first language (L1) acquisition is a matter of learning to use the language, rather than developing the knowledge required to make grammaticality judgments about one's own language (Allen & Seidenberg 1999: 120). Nor should language be regarded as instinctual; feral children may spontaneously learn to walk, but do not spontaneously generate a novel language in the absence of an ambient one (c.f. Lane 1979; Curtiss 1981). We are not born to use language, but can easily accommodate it, if sufficient input avails itself. Thus, from a neurological perspective, language learning can be accommodated by the brain in the same way that facial recognition is. Studies into categorical perception of infants (at four months old) demonstrate the brain's ability to perform comparison of two stimuli that are highly similar (Eimas et al. 1971). In the event of exposure to language, infant auditory neurological systems encode aural stimuli and make connections to other systems (such as visuo-spatial processing and emotion: Ellis 2002: 655). A key feature of the input to this system is the distribution of forms; similar shades of phonetic features may occur more frequently than others. The following two studies provide insight into how auditory processing of linguistic information is influenced by distributional facts of the input.

While categorical perception is often brandished as the evidence that the phoneme is a psychologically real entity, current research into how distribution affects perception of phonetic contrasts forces us to re-evaluate how we conceive of the phoneme in a neuro-cognitive dimension. A study by Maye and Weiss (2003) reports on the discriminatory behavior of 8-month old infants, when exposed to different distributional patterns of tokens of a phonetic category (in this case Voice Onset Time: VOT). Two different types of distribution were employed: a bimodal one, and a monomodal one. Test group infants were exposed to tokens from the distribution for 2.5 minutes; the control group was presented with random tones. The experiment measured looking times as the dependent variable to determine whether a contrast was being perceived. Both groups (mono- and bimodal) were tested on the same phonetic stimuli, varying in VOT by 50ms. The results of their experiment show that exposure to a bimodal distribution, for even as little as 2.5 minutes, can prime categorical perception in infants. This indicates that the perceptual system exhibits a high degree of neural plasticity, and its corresponding representations are impacted by distributional information.

The hypothesis that L1 acquisition of phonemes is dependent on assessment of minimal pairs is challenged by Maye and Gerken (2000). The minimal pair hypothesis claims that an infant searches for and analyzes pairs of words minimally varying on a single phonetic category to infer what phonemes exist in the language (MacKain 1982). However, serious doubt is cast over this idea when one considers the receptive vocabularies of infants at the age that they start to display phonemic perception (Maye & Gerken 2000). Receptive vocabulary development begins at 12 months, but sensitivity to the ambient language's

phonemic contrasts (the stage of perceptual reorganization) begins six months prior. In addition, incipient vocabularies rarely can be demonstrated to contain the extensive sets of minimal pairs required to allow such a phonemic analysis to be undertaken. Maye & Gerken attempt to validate a different hypothesis: phonemic acquisition is claimed to be the product of a perceptual reflex to sound distributions in the ambient language; this is known as the distribution-based hypothesis. Interesting support for this idea comes from experiments involving phonotactic pattern frequencies; children show a preference for high frequency patterns (e.g. *mubb*) over low frequency ones (e.g. *jurth*). Phonetic distributions of a language's phonemic categories are thought to be cognitively represented as nonuniformities in neuron firing patterns for a given phonetic category gradient (viz. the research of Guenther & Gjaja 1996). Such a model would thus account for, in a neurologically valid way, the behavioral flip-flop that occurs when infants begin to exhibit evidence of phonemic categorization and loss of non-native contrast perception.

Maye & Gerken (2000) test the distribution-based hypothesis by investigating the effect that exposure to a bimodal distribution on phoneme acquisition has, compared with exposure to a monomodal distribution. Adult participants were exposed to set of monosyllabic words from a pseudo language and then tested on their ability to detect whether words were different or the same in a pair-wise comparison. The results indicate that groups exposed to a bimodal distribution of the experimental contrast (/d/~t/ pairs) treated it as a set of phonemes rather than a single category. The implication is that the bimodal group learned to identify minimal pairs without explicit training or semantic information. The findings of this study apparently run contrary to the idea that adults have diminished capacity for perceiving non-native contrasts. While it is true that English contains the very contrast being acquired in the experiment, this cannot be used as an explanation for performance of the bimodal group on the discrimination task because the monomodal group performed significantly differently on the same pairs in a monomodal distribution. These results set the stage for future research into L2 acquisition which incorporates frequency to be discussed in section 7.0.

6 Criticisms of frequency related accounts

To complete the review section of this article, I will give a presentation of criticisms against Ellis' article. The goal of this section is to anchor the discussion in a well-rounded discourse and to hopefully provide a common ground where the best of both approaches may be applied to a new hybrid model (see section 7.0).

The first topic under discussion is language innateness. Hulstijn (2002: 270) raises several concerns about the assumptions made by those who develop language learning neural networks (e.g. connectionists). The criticism is that these developers should not assume that the model is learning language from scratch as it has the architecture necessary to both perceive and store stimuli in a simulated fashion. Under the assumption that this accurately represents infant cognition, the claim is that we still cannot be exempt from talking about language as being non-innate, and thus the nativist hypothesis still prevails, albeit in an altered form. Indeed, Hulstijn raises a legitimate concern about the nature of cognition and perception; how is it that the developing human mind begins to perceive, store, and recognize sense-data from its environment. Neural network models do begin with this assumption, but, as has been discussed, this type of innateness is radically different than the type perpetuated

in the UG framework. A detailed discussion of this has already been reviewed; i.e. the work of Elman (1999). Even Hulstijn concedes that infants "appear to possess the ability to count, through which they become subject to the powerful influence of frequency" (2002: 270). The problem of initial cognition is regarded as unresolved, but it is a matter to be decided by neurological and cognitive scientists as it concerns how sensory data is initially interpreted and stored by all of the perceptual systems of the body and not just the auditory system.

A further concern raised by Hulstijn is that implicit and explicit knowledge are impacted by frequency in different ways. Presumably, implicit knowledge, such as neural representations of auditory stimuli, is more subject to frequency effects by Hulstijn's account (2002: 271). The main point of his argument is that explicit knowledge about lexical form-meaning pairs responds to frequency in a manner that is different than implicit knowledge. Thus, exposure to a single token can lead to permanent acquisition of the word, and sometimes repeated exposure fails to trigger learning. These issues underscore the point that frequency is not intended to be taken as a panacea, used to resolve all issues of language learning. Rather, these examples indicate other psycho-cognitive phenomena such as *noticing* (e.g. Robinson 1995) and *neglect* (e.g. Mesulam 1981, 1990) may play a role, in addition to other possibilities.

The final comment Hulstijn makes concerning frequency comes from the case of L2 learners who have had more exposure to the L2 than their L1. These learners tend to demonstrate persistent and fossilized errors in morphosyntactic form pronunciation and use. Hulstijn's point is that despite the massive amount of L2 exposure these individuals receive, errors are not ameliorated as a frequency based account might lead us to suspect. Evidently, the case of L2 language is unique in that the L1 appears to inhibit the formation of additional grammatical and phonological knowledge. Hulstijn's concern is valid and serves as an additional factor that should be regarded in any theory attempting to explain L2 acquisition. At present, based on the discussion held in preceding sections, a possible conspiratory answer might be given to the question of how the L1 impacts the L2. Assuming that the neurocognitive system is most impressionable at infancy before any external input has been received, the impact of L1 data, and the frequency effects that correspond with it are considerable. By the time that infant becomes a child and matures in her language use, the neurological representations are firmly entrenched. These representations are hardened in the formative years having undergone neurological definition and pruning (Kosslyn 2005: 75) and are in play every time new stimulus is received. Thus, by the time a second language is encountered, the perceptual system must accommodate the new data through the old system, which will filter and distort the perception of foreign phonetic categories in a manner tantamount to the ideas expressed in the Native Language Magnet theory of L2 phonetic category acquisition (Guenther & Gjaja 1996; Iverson et al. 2003).

Gass and Mackey (2002) respond to Ellis (2002) by arguing that frequency is a complex matter and cannot be unequivocally applied to explanations of second language acquisition (SLA). Their intention, however, is not to rule out frequency as an explanatory factor in SLA, but rather to argue that it is a component of a confluence of forces acting upon learners. The first observation they make is that constructions that are rich in semantic content and frequent in the input, are nevertheless subject to relatively rigid placement in a developmental sequence. The example raised is that L2 learners acquire higher order question formation (e.g. Wh-questions with auxiliary inversion, negative questions, and tag questions: see Mackey 1999) late in the developmental sequence, despite their high frequency in the

input. The authors also note, however, that frequency cannot be totally ruled out as there is evidence that grammatical constructions beyond the learner's current level are stored until the learner is ready to deal with them (Gass & Mackey 2002: 254).

Another criticism of frequency based accounts that Gass and Mackey (2002) raise is that ungrammaticality cannot be learned through positive evidence in the input; yet, it is clear that this type of knowledge is part of knowing a language. As only elements in the language that are actually instantiated can be countable, the claim is that frequency cannot be shown to play a role. On the other hand, they observe that the sheer absence of a particular construction in itself is a type of frequency information. Further argumentation supporting the generative view comes from observations made by White (1989) concerning an example of a linguistic complexity that can only be learned by being privy to innate knowledge of grammar. The particular construction is *wanna* contraction, which is banned in locations involving syntactic constituent extraction in between the two elements of the contraction (i.e. 'I want him to win the race'; c.f. 'Who do you want *t* to win?' vs. *'Who do you wanna win the race?'). The claim made by Gass and Mackey based on evidence such as this, is that mere language use subject to frequency effects could never lead to the type of abstract structure that is required to determine grammaticality. While at present there is no clear answer to this question, the work of researchers such as Allen and Seidenberg (1999) and Elman (1999) present cases of neural networks acquiring abstract grammatical structure. In the former, a neural network demonstrates the ability to perform grammaticality judgments on sentences with auxiliary inversion or tag questions, which involve movement and ellipsis, respectively. Elman's model is capable of employing the correct agreement on verbs even when a relative clause intervenes between the subject and the verb. While these cases are not as complex as those involving traces, they serve to demonstrate that modeling the acquisition of abstract syntax is not fully out of our reach.

7 A frequency-integrated approach to learning phonetic categories in SLA

The acquisition of second language (L2) phonemes has been a long standing matter of controversy. While many contend that the first language (L1) acts as a filter, the theoretical perspectives differ. From the perspective of phonologists, L2 learning is a matter of phonemic analysis of L2 phones into the phonological categories of the L1 (Brown 1997; LaCharité & Prévost 1999; Escudero 2006). The mechanism behind the phonemic analysis is the set of minimally contrastive features that drives the language learner's perception of foreign sounds. A classic case of this comes from Japanese (Brown 2000: 12): Japanese lacks a contrast between coronal approximants, unlike English, which has /l/ and /r/. Correspondingly, the minimally contrastive specification for the Japanese coronal approximant does not include the feature [coronal]. Given the lack of phonemic contrast of laterality in the language, English /r/ and /l/ are perceptually filtered into the same category. Consequently, the contrast is difficult to acquire and it is the learner's task to identify the set of features that drives the foreign contrast (c.f. Grenon 2006; Mah et al. 2006). The perspective of phonetically oriented studies runs contrary to the idea that features drive the perception of foreign sounds. Perception is fundamentally a matter of the psychoacoustic 'spaces' that an L2 learner carries with them from their L1. Thus, the ability to notice phonetic detail of a linguistically relevant contrast depends on the degree of perceptual similarity (viz. Flege's equivalence classification) to the L1 psychoacoustic space. An example of this comes

from a case of differential substitution of French /y/ by English and Brazilian Portuguese (BP) learners (Rochet 1995). The English speakers tended to produce [u] for the sound, while the BP speakers produced [i]. It is well known that different languages possess different acoustic vowel spaces (Rochet 1995: 386; Johnson 1997: 102-7). Rochet argues that the learners hear the L2 sounds in the terms of their L1 phonological system by means of equivalence classification (see below for more details); accordingly, /y/ acoustically maps up with English /u/³, while it is more close to BP /i/.

While both perspectives have presented compelling portrayals of the language learning process, a unified account is still lacking. The proposal made here is that a unified picture of L2 phonological acquisition will need to expand the scope of its research paradigm.

The critical area of research requiring elaboration is in the nature of how perception of the speech stream and phonemes map onto one another. Flege's Speech Learning Model (e.g. 1992, 1995, 2003) presents the idea that perception of phonetic categories is plastic and can respond to changes in the ambient language be it L1 or L2. Fundamentally, however, acquiring a new phonetic category is a matter of perceptual discrimination based on the active phonetic categories of the L1, and is subject to decline as a person ages. The mechanism driving perceptual equivalence classification is, at best, vaguely defined as a matter of acoustic similarity (Flege 1992: 572). A number of studies by Flege (1991, 2003; Flege et al. 2003) present evidence that L2 sounds are variably identified by L1 speakers as equivalent to an L1 sound. The success of acquiring a new phonetic category is argued to be dependent on the nature of this classification. Sounds representing a *new* phonetic category are acquired early on in the learning process because that particular category lacks competition from the L1 acoustic space. The difficulty lies in sounds that are *similar*, but not the same acoustically. The difficulty in perception lies in the fact that the phonetic category becomes absorbed into the pre-existing L1 acoustic space. This effect is exemplified by the above discussion of English and Brazilian Portuguese learners of French (Rochet 1995). In this case, the SLM would predict that acquisition of French /y/ would be difficult because both learner groups possess an acoustically *similar* L1 phonetic category (English /u/ and Brazilian Portuguese /i/).

This model is lacking in certain respects. First of all, the precise nature of perceptual mapping is poorly understood. Most studies approach the problem from an acoustic perspective, typically citing basic acoustic properties like formant structure, intensity, duration, and the like as grounds for comparison of L1 and L2 sound sets (e.g. Rochet 1995; Moisik 2006). In the Perceptual Assimilation Model (PAM: Best 1995; Best et al. 2001), mapping is a matter of both perceptual and articulatory degree of similarity; the degree of similarity can be determined by analyzing 'goodness-of-fit' judgments given by native speakers when assessing how much a foreign sound corresponds to an L1 phonetic category. Another interesting proposal was that psychoacoustic sensitivities can be modified by the phonetic categories of the L1. This is the position represented by the Native Language Magnet (NLM: Iverson et al. 2003) model. For example, native speakers of English show an increased sensitivity to changes in F3; this sensitivity is not attested for native Japanese speakers, who display an increased F2 sensitivity. Such observations lead Iverson et al. (2003) to conclude that the Japanese psychoacoustic map impedes the acquisition of the /l-/r/ contrast in English. Flege's model forms predictions based on goodness-of-fit judgments

³ Notably, /u/ tends to be quite fronted in its production in English.

(Flege 2003). While all of these different approaches to perceptual mapping provide insight into the nature of the problem, there remains the problem of what cognitive and neurological factors are involved.

There are also cases where the SLM fails to predict the behavior of L2 learners. A surprising result was obtained by Moisik (2006) where English learners of German managed to acquire dark-schwa, a sound classed as acoustically similar to English schwa (see below for details). The SLM would hold that such a contrast would not be attested by learners until much later in their language learning career.

It is proposed that, as Ellis (2002) argues, frequency should be incorporated into the research paradigm of second language acquisition. Currently, little work has been done on exploring SLA with usage-based or emergentist frameworks. Bybee's (2001) usage-based grammar (see section 3.0) encapsulates many of the ideas put forth by these two frameworks, and it will help to review it here. In her model, the concept of the phoneme is radically reevaluated in usage-based grammar. Bybee's argues convincingly for a type of 'radically overspecified' grammar (2001: 37-40), where redundant 'allophonic' information is actually incorporated into the representations of lexical units; the consequence of such a position is that the set of rules 'generating' the grammar is nearly non-existent. Rather, in Bybee's view, the process of speaking largely involves the activation of stored neuromuscular units associated with semantic material, as one produces the speech stream (2001: 15). In this perspective, the phoneme can be conceived of as a localized cluster of psycho-acoustically related units. The set of units that make up the cluster are referred to as exemplars, none of them exactly alike, but functionally classed according to the categorical exigencies of the ambient language. Evidence from first language acquisition studies show that distributional factors play a role in determining whether infants will perceive a phonetic contrast or not (Maye & Weiss 2003). The manifest behavior of individuals displaying categorical perception all but obscures the possibility that the representation of a single 'phoneme' could comprise the thousands of tokens an individual has been exposed to over their lifetime. Assuming Bybee's concept of the phoneme, the question is then, how can this re-conception of the phoneme be integrated into second language learning. Bybee's model does not explore this possibility. The goal, here, is to outline a model that would unify the developments proposed by the SLM and similar models, with the type of work that has been done on frequency by Bybee (e.g. 2000, 2001) and others (e.g. Pierrehumbert 2001).

Thus, the goal of future research on this question should be to robustly outline the relationship between frequency and the perception of foreign phones. By unifying Bybee's and Flege's models, with the insights of emergentism also taken into consideration, this goal might be accomplishable. It is possible to synthesize the tenets⁴ of the theories to come up with a set of predictions that would characterize the hypothesis of this new hybrid theory. They are as follows:

Prediction 1:

Frequency = strength of representation; the more a learner is exposed to second language input, the stronger the representations will be. Sounds that occur with a high degree of frequency will therefore be acquired faster than those that are occur with low frequency.

⁴ See section 3.0 for a discussion of the principles of Bybee's usage-based model.

Prediction 2:

The phonetic/phonological representations of multiple languages are stored in the same neurological loci (contra-modularity; phonetic categories exist in common phonological space (Flege 1995: 239)); the representation of phonemes (in either language) can change over time as more phonetic exemplars are added to the cluster. As the L1 is more firmly entrenched⁵ it will be more resistant to change in the face of new exemplars.

Prediction 3:

Similarity and difference (i.e. referring to Flege's *similar* and *new* equivalence classification scheme; 1995: 239) are definable on a neurological level: the center of mass for phoneme exemplar clusters defines the field in which a non-native sound can be determined to be more like the native sound compared to another non-native sound. This prediction is testable by means of a neural network simulation, where acquisition time of a non-native category is tested with varying degrees of similarity.

Prediction 4:

'Age of learning' effects are predicted on account of neurological plasticity and the ever increasing collection and reinforcement of native phonetic categories.

The troubling findings of Moisik (2006), alluded to above, serve as an illustration of how this hybrid approach can be applied to SLA, specifically focusing on *prediction 1*. In Moisik (2006) the production of dark-schwa (a German sound symbolized as [ɐ] in the IPA; found in words such as *bitter* [bitɐ] 'bitter') by English learners of German was examined and compared to productions of German schwa (in words such as *bitte* [bitə] 'please'). The prediction of this study was that the English speakers would not be able to produce a contrast between the sounds given their acoustic similarity (see Moisik 2006: section 3.3⁶; also see Moulton 1962: 37), but would rather produce something similar to English schwa for both. This prediction was made using the SLM as a framework: thus, dark-schwa was predicted to be classed as *similar* to English schwa and therefore difficult to acquire. The results, however, indicated that the speakers did make a contrast between the sounds. While the productions were not exactly native like, acoustic analysis revealed that all English learners of German produced dark-schwa and schwa differently.

In terms of the original SLM this finding is problematic because the SLM predicts that sounds classed as perceptually *similar* should be difficult to acquire (Flege 1995: 239). On the assumption that dark-schwa is perceptually similar to English schwa, the SLM fails to make the correct prediction. Dark-schwa was acquired, as evidenced by the production of contrast between dark-schwa and schwa, even though the learners were all relatively inexperienced with German (Moisik 2006: 52-5).

⁵ Over time, as more and more exemplars populate a cluster, the pattern becomes resistant to change and less variable (Pierrehumbert 2001: 11).

⁶ n.b.: dark-schwa is closer to English schwa than any other vowel in English ([a] & [ʌ] were the next most similar English sounds).

With the hybrid theory, however, the behavior of the English learners of German actually confirms the first prediction: frequency of the L2 input amounts to stronger representations. There is ample evidence that dark-schwa is among one of the most frequent sounds in German. Dark-schwa is the standard production of nouns ending in <-er> like *Zauber* [tsawbɐ] 'magic', plurals such as *Kinder* [kindɐ] 'children', and the comparative morpheme /-ər/ as in *besser* [bɛsɐ] 'better' (Hall 1992: 101). It is also found as an off-glide when it follows a vowel (Hall 1992: 156), or in the frequently used prefixes *er-*, *her-*, *ver-* (pronounced [ɛʁ-], [hɛʁ-], and [fɛʁ-]: Hall 1992: 101). The contrast between schwa and dark-schwa in German is described as occurring with "high frequency and high functional load (Hall 1992: 101; Barry: 1995). Thus, it is reasonable to conclude that L2 learners of German will have ample input for dark-schwa. An explanation in the terms of the hybrid theory would amount to the following:

- 1) dark-schwa tokens are perceptually equated with English schwa, thus the sounds are similar (SLM).
- 2) the high frequency of dark-schwa strengthens the representation of the sound allowing it to form a unique phonetic category (usage-based approach).
- 3) therefore, despite similarity of the sounds, the frequency of the foreign target is high enough to overcome the *similarity* effect and allow for rapid acquisition sound production.

This illustration of how the hybrid approach to the SLM works represents the first steps towards incorporating knowledge about frequency into traditional models of phonetic and phonological acquisition in the context of second language acquisition. Further studies will reveal if frequency is sufficient to provide an explanation for interlingual behavior, or if other performance factors need to be integrated as well, such as "semantic basicness, salience, communicative intent, and relevance" (Ellis 2002: 178). Additionally, only *prediction 1* of the hybrid theory could be supported with the Moisik (2006) data; future studies are required to test the other three predictions, all of which require the construction of neural network simulations. The direction that these predictions point future research towards may allow us to begin to answer some of the difficult questions posed by Flege's SLM model: for example, how does mapping of L2 sounds onto L1 sounds actually work?

8 Conclusion

The hybrid approach presented in this paper only represents one possible framework for making linguistic research, and specifically second language acquisition, more answerable to questions concerning performance factors and the neurological implementation of language. Future research in this framework needs to focus on the representation of the phoneme and how it impacts exposure to foreign sounds. Neurologically, this task is, admittedly, extremely difficult, but neural networks are allowing us to conceive of how it might be accomplished (Nadel et al. 1989: 21; Plaut & Kello 1999). The hybrid approach makes predictions that open up new avenues to explore Flege's Speech Learning Model: for example, simulation of equivalence classification in a neural network model is feasible. Several 'test subject' networks could be created, all of which begin with the same predetermined weightings of network connections. These connections would represent the

distribution of exemplars in the 'L1', i.e. the networks phonemic representations. Each network could then be presented with the same set of 'L2' phones that differed in some fashion from the average pattern of activation for any given L1 phoneme. To test the impact of frequency on L2 phoneme acquisition, a target L2 phone that would be classed as *similar*⁷ to an L1 phone could be identified and its frequency in the L2 corpus could be varied for each network. At the end of a 'learning task', the patterns of activation for the L2 target sound in each network could be measured to determine to what degree frequency of the L2 target form played a role in its acquisition. The degree of similarity of the network's representation of the L2 target pattern to the actual L2 target pattern would indicate the extent to which it had acquired the phonetic category. An experiment such as this would provide insight into the way that equivalence classification operates on a neurological level and allow us to test the remaining predictions of the hybrid approach (*predictions 2 to 4*).

The goal of this article was to deal with the theoretical issues that arise when frequency is considered to be a relevant factor in linguistic explanation. It turns out that many of the assumptions about language learning, language change, and representation need to be re-evaluated. This re-evaluation is on-going and has been for more than a decade. We are also at an exciting time where questions of how neurological systems create symbolic representations are becoming more accessible to us. Modern computing power is enabling complex simulations of neural networks, and these are providing insight into how the *mind* comes to exist in the *brain* (Nadel et al. 1989: 18-22). Linguistic theories like emergentism and usage-based grammar are making connections between linguistic facts and neurological ones. The proposal here strongly echoes Ellis' (2002) argument, that frequency has a place in linguistic explanation, and more specifically in explaining second language acquisition. Frequency is not the entire picture, but it is certainly an important factor.

References

- Allen, J., & Seidenberg, M.S. (1999). The emergence of grammaticality in connectionist networks. In B. MacWhinney (Ed.) *Emergentist approaches to language: Proceedings of the 28th Carnegie Symposium on cognition*. Hillsdale, NJ: Lawrence Erlbaum Associates.
- Barry, W. J. (1995). Schwa vs. schwa + /r/ in German. *Phonetica* 52. 228–235.
- Best, C.T. (1995). A direct realist perspective on cross-language speech perception. *Speech perception and Linguistic Experience: Theoretical and Methodological Issues in Cross-language Speech Research*. W. Strange ed. York: Timonium, MD. 167-200.
- Best, C.T., McRoberts, G.W. and Goodell, E. (2001). Discrimination of non-native consonant contrasts varying in perceptual assimilation to the listener's native phonological system. *Journal of the Acoustic Society of America* 109. 775-794.
- Blevins, J. (2004). *Evolutionary phonology*. Cambridge University Press.

⁷ In this case, similarity would be defined according to the details laid out in *prediction 3* of the hybrid model.

- Boersma, P. (1998). *Functional phonology: formalizing the interactions between articulatory and perceptual drives*. The Hague, Holland Academic Graphics.
- Boersma, P. & Hayes, B. (1999). *Empirical tests of the Gradual Learning Algorithm*. Manuscript, University of Amsterdam and UCLA.
- Brown, C. (1997). *The Acquisition of Segmental Structure: Consequences for Speech Perception and Second Language Acquisition*. Doctoral Dissertation. Montreal, PQ: McGill University.
- Brown, C. (2000). The interrelation between speech perception and phonological acquisition from infant to adult. In J. Archibald, (Ed.) *Second Language Acquisition and Linguistic Theory*. Blackwell. 4–63.
- Bybee, J. (2000). The phonology of the lexicon; evidence from lexical diffusion. In M. Barlow and S. Kemmerer (Eds.) *Usage-Based Models of Language*. Stanford: CSLI.
- Bybee, J. (2001). *Phonology and language use*. Cambridge: Cambridge University Press.
- Bybee, J. & Hopper, P. (2001). *Frequency and the Emergence of Linguistic Structure*. Amsterdam: John Benjamins.
- Chomsky, N. (1957). *Syntactic structures*. The Hague: Mouton de Gruyter.
- Chomsky, N. (1965). *Aspects of a theory of syntax*. Cambridge, MA: MIT Press.
- Chomsky, N. (1995). *The Minimalist Program*. MIT Press, Cambridge, MA
- Christiansen, M. H., Allen, J., & Seidenberg, M. S. (1998). Learning to segment speech using multiple cues: A connectionist model. *Language and Cognitive Processes* 13. 221–268.
- Coleman, J. & Pierrehumbert J. (1997). Stochastic Phonological Grammars and Acceptability. *3rd Meeting of the ACL Special Interest Group in Computational Phonology: Proceedings of the Workshop*, 12 July 1997. Association for Computational Linguistics, Somerset NJ. 49-56.
- Cook, V.J. (1988). *Chomsky's Universal Grammar: An Introduction*. Cambridge, Mass.: Basil Blackwill.
- Curtin, S. (2002). *Representational richness in phonological development*. Doctoral dissertation, University of Southern California.
- Curtiss, S. (1981). Dissociations between language and cognition: Cases and implications. *Journal of Autism and Developmental Disorders*, 11. 15-30.

- Eimas, P. D., Siqueland, E. R., Jusczyk, P., & Vigorito, J. (1971). Speech perception in infants. *Science* 171. 303-306.
- Ellis, N. C. (1998). Emergentism, connectionism and language learning. *Language Learning* 48, 631-64.
- Ellis, N. C. (2002). Frequency effects in language processing: a review with implications for theories of explicit and implicit language acquisition. *Studies in Second Language Acquisition* 24, 143-188.
- Elman, J. L. (1990). Finding structure in time. *Cognitive Science* 14. 179-211.
- Elman, J. (1993). Learning and development in neural networks: The importance of starting small. *Cognition*, 48. 71-99.
- Elman, J. (1999). The emergence of language: A conspiracy theory. In B. MacWhinney, Ed. *The emergence of language*. 1-27. Mahwah, NJ: Erlbaum.
- Elman, J. L., Bates, E. A., Johnson, M. H., Karmiloff-Smith, A., Parisi, D., & Plunkett, K. (1996). Rethinking innateness: A connectionist perspective on development. Cambridge, MA: MIT Press.
- Escudero, P. (2006). A linguistic model of the interrelation between perceptual and lexical L2 development. In the *Proceedings of Generative Approaches to Second Language Acquisition*. May 28-30, 2006.
- Flege, J. (1992). Speech learning in a second language. In C. A. Ferguson, L. Menn, and C. Stoel-Gammon, (Eds.) *Phonological Development: Models, Research, Implications*. 565-604. Timonium, MD: York Press.
- Flege, J. (1995). Second language speech learning. Theory, findings, and problems. In W. Strange ed. *Speech perception and linguistic experience: Issues in cross-language research*. 233-277. Timonium, MD.: York Press.
- Flege, J. (2003a). Assessing constraints on second-language segmental production and perception. In N. Schiller & A. Meyer (Eds.). *Phonetics and phonology in language comprehension and production: Differences and similarities*. Vol. 6, 319-355. Berlin: Mouton de Gruyter.
- Flege, James & Carlo Schirru, and Ian R. A. MacKay. (2003b). Interaction between the native and second language phonetic subsystems. *Speech Communication* 40. 467-491.
- Gass, S. M. & A Mackey. (2002). Frequency effects and second language acquisition: A complex picture? *Studies in Second Language Acquisition* 24. 249-260.

- Greenberg, J. H. (1966). *Language universals*. The Hague, The Netherlands: Mouton.
- Greenspan, R. J. (1995). Understanding the genetic construction of behavior. *Science American* 272. 74–79.
- Grenon, I. (2006, May). Adults still have direct access to Universal Grammar: Evidence from the perception of a non-native feature contrast. Paper presented at the conference of *Generative Approaches to Second Language Acquisition*. Banff, Alberta.
- Guenther, F. H., & Gjaja, M. N. (1996). The perceptual magnet effect as an emergent property of neural map formation. *Journal of the Acoustical Society of America* 100. 1111–1121.
- Hall, C. (1992). *Modern German Pronunciation: An Introduction for Speaker's of English*. Glasgow: Bell & Bain Ltd.
- Hayes, B. & MacEachern, M. (1998). Quatrain Form in English Folk Verse. *Language* 74. 473-507.
- Harris, R. (1990). *The Foundations of Linguistic Theory: Selected Writings of Roy Harris*. Nigel Love (Ed.). London: Routledge.
- Hopper, P. (1987). Emergent grammar. In the Proceedings of the *Berkley Linguistics Society* 13. 139-57.
- Hulstijn, J. (2002). What does the impact of frequency tell us about the language acquisition device? *Studies in Second Language Acquisition* 24. 269-273. Cambridge University Press.
- Iverson, P., Kuhl, P.K., Akahane-Yamada, R., Diesch, E., Tohkura, Y., Kettermann, A., & Siebert, C. (2003). A perceptual interference account of acquisition difficulties for non-native phonemes. *Cognition* 87(1). B47–57.
- Jusczyk, P. W., Paul L., & Charles-Luce, J. (1994). Infants' sensitivity to phonotactic patterns in the native language. *Journal of Memory and Language* 33. 630-645.
- Johnson, K. (1997). *Acoustic and auditory phonetics*. Cambridge, MA: Blackwell.
- Kosslyn, S. M. (2005). *Fundamentals of Psychology: the brain, the person, the world*. 2nd Edition: Rosenberg, R. S. (Ed.). Pearson Education Inc.

- LaCharité, D. & Prévost, P. (1999). The role of L1 and teaching in the acquisition of English sounds by francophones. In A. Greenhill, H. Littlefield & Tano, C. (Eds.), *Proceedings of the 23rd Annual Boston University Conference on Language Development*. Somerville, MA: Cascadilla Press. 373-385.
- Lane, H. (1979). *The wild boy of Aveyron*. London: Granada Publishing.
- Langacker, R. W. (1988). A Usage-Based Model. In B. Rudzka-Ostyn (Ed.), *Topics in Cognitive Linguistics*, 127-161. Amsterdam: John Benjamins.
- Lively, S. E., Pisoni, D. B., & Goldinger, S. D. (1994). Spoken word recognition. In M. A. Gernsbacher (Ed.), *Handbook of psycholinguistics* 265–318. San Diego, CA: Academic Press.
- MacDonald, M. C. (1994). Probabilistic constraints and syntactic ambiguity resolution. *Language and Cognitive Processes* 9. 157–201.
- MacKain, Kristine S. (1982). Assessing the role of experience on infants' speech discrimination. *Journal of Child Language* 9. 527-542.
- Mackey, A. (1999). Input, interaction, and second language development: an empirical study of question formation in ESL. *Studies in Second Language Acquisition* 21. 557–587.
- MacWhinney, B. (Ed.). (1998). *The emergence of language*. Hillsdale, NJ: Lawrence Erlbaum.
- Mah, J., Goad, H., & Steinhauer, K. (2006). The trouble with [h]. In the Proceedings of Generative Approaches to Second Language Acquisition. May 28-30, 2006.
- Maye, J. & Gerken, L. (2000). Learning phonemes without minimal pairs. In S. C. Howell, S. A. Fish, & T. Keith-Lucas (Eds.), *Proceedings of the 24th Annual Boston University Conference on Language Development*. 522-533. Somerville, MA: Cascadilla Press
- Maye, J. & Weiss, D. J. (2003). Statistical cues facilitate infants' discrimination of difficult phonetic contrasts. In B. Beachley, A. Brown, & F. Conlin (Eds.), *Proceedings of the 27th Annual Boston University Conference on Language Development*. Somerville, MA: Cascadilla Press: 508–518.
- Mesulam, M. M. (1981). A cortical network for directed attention and unilateral neglect. *Annals of Neurology* 10. 309-25
- Mesulam M. M. (1990). Large-scale neurocognitive networks and distributed processing for attention, language, and memory. *Annals of Neurology* 28. 597–613.

- Moisik, S. (2006). *The L2 Phonetic Acquisition of Nuclear-/r/: The Case of English and German*. Honours Thesis. University of Calgary.
- Moulton, W. (1962). *The Sounds of English and German: A systematic analysis of contrasts between the sound systems*. Chicago and London: The University of Chicago Press.
- Nadel, L., Cooper, L. A., Culicover, P., & Harnish, R. M. (1989). *Neural connections, mental computation*. MIT Press, Cambridge, MA.
- Nicoladis, E., & Yin, H. (2002). The Role of Frequency in Acquisition of English and Chinese Compounds by Bilingual Children. In B. Skarabela (Ed.), *Proceedings of the 27th Annual Boston University Conference on Language Development*. Somerville, MA: Cascadilla Press. 441-52.
- Nimmo, L. M., & Roodenrys, S. (2002). Syllable frequency effects on phonological short-term memory tasks. *Applied Psycholinguistics* 23. 643-659.
- O'Leary, D. D. M. (1989). Do cortical areas emerge from a protocortex? *Trends in Neuroscience* 12. 401-406.
- Pierrehumbert, J. (2001). Exemplar dynamics: Word frequency, lenition, and contrast. In Bybee, J. & P. Hopper (Eds.), *Frequency effects and the emergence of linguistic structure*. John Benjamins, Amsterdam. 137-157.
- Pierrehumbert, J. (2002). Word-specific phonetics. In C. Gussenhoven, & N. Warner (Eds.), *Laboratory phonology VII (phonology and phonetics)*. Berlin: Mouton de Gruyter. 101-140.
- Pinker, S. (1994). *The language instinct*. Penguin Books, London.
- Plaut, D. C., & Kello, C. T. (1999). The emergence of phonology from the interplay of speech comprehension and production: A distributed connectionist approach. In B. MacWhinney (Ed.), *The emergence of language*. Mahwah: Lawrence Erlbaum Associates. 381-415.
- Prince, A. S., & Smolensky, P. (1993). Optimality theory: Constraint interaction in generative grammar. *Technical Report 2*. Center for Cognitive Science, Rutgers University.
- Robinson, P. (1995). Attention, memory, and the 'noticing' hypothesis. *Language Learning* 45. 283-331.
- Roca I. (1994). *Generative phonology*. Routledge: London & New York.

- Rochet, B. (1995). Perception and production of second-language speech sounds by adults. In W. Strange (Ed.), *Speech perception and linguistic experience. Issues in cross-language research*. 379-410. Timonium, MD.: York Press.
- Rudzhka-Ostyn, Brygida. (1988). In B. Rudzhka-Ostyn, (Ed.), *Topics in Cognitive Linguistics*. Philadelphia: John Benjamins.
- Saffran, J. R., Aslin, R. N., & Newport, E. L. (1996). Statistical learning by 8-month-old infants. *Science* 274. 1926–1928.
- Saffran, J. R., Johnson, E. K., Aslin, R. N., & Newport, E. L. (1999). Statistical learning of tone sequences by human infants and adults. *Cognition* 70. 27–52.
- Skinner, B. F. (1957). *Verbal behavior*. New York: Appleton-Century-Crofts.
- Smolensky, P. (1997). Connectionist Modeling: Neural Computation/Mental Connections. In J. Haugeland (Ed.). *Mind Design II*. Cambridge, Massachusetts. Bradford Book, MIT Press.
- Vihman, M. M. (1996). *Phonological development: The origins of language in the child*. Oxford, UK: Blackwell.
- Watson, J. B. (1924). *Behaviorism*. Chicago: University of Chicago Press.
- White, L. (1989). *Universal Grammar and second language acquisition*. Amsterdam: Benjamins.
- Zuraw, K. (2000). *Patterned Exceptions in Phonology*. Doctoral dissertation, University of California, Los Angeles.

Phonological Changes in Korean

Park, Junsuk

Department of Linguistics, Michigan State University
parkju21@msu.edu

ABSTRACT

This paper investigates the phonological changes that have occurred in Korean. According to my research, Korean has undergone three major phonological changes since the 1980s: 1) vowel shortening in near-homophones, 2) the merger of different final consonants into one consonant at word-final position and 3) consonant cluster reduction. Among these changes, the most noticeable change is the vowel shortening, which is observed in the mid-vowels of near-homophones. This phenomenon has been so prevalent that nearly all the near-homophones that were distinguished by the different vowel length came to be pronounced as homophones.

The second phenomenon, the merger of different final consonants into one consonant at word-final position is spreading its effects to more words in Korean, resulting in the gradual disappearance of the phonological value of word-final consonants before a vowel-initial suffix.

The third phenomenon, consonant cluster reduction is a relatively recent phenomenon. However, this phenomenon has evidently started in Korean phonology. In this paper, I address these three phonological phenomena with some empirical data.

Keywords: Korean; phonology; leveling; near-homophone; vowel length; mid-vowel; contextual information; usefulness; suffix; consonant cluster

1 Introduction

Korean seems to have undergone phonological changes over the past 30 years. In this paper, I attempt to explore phonological and phonetic changes that have occurred in Korean. I also address some evidence of these changes in Korean and what socio-linguistic factors have caused these changes. Phonological changes occur most frequently while syntactic changes occur most rarely and, because of this rarity, are the hardest to notice. As I have investigated changes that have occurred in Korean for this paper, I have found out that this is quite true of Korean, too. One interesting finding of my research is that the changes in Korean have continued regardless of the vigorous efforts of Korean linguists to purify Korean. One thing that I was also able to notice is that phonological leveling phenomena have happened quite frequently in Korean and there has been a lot of evidence that prove this point over the past two or three decades.

2 Phonological changes in Korean

2.1 Loss of vowel length distinction in near-homophones – a type of phonological leveling

One of the most noticeable and important changes that has occurred in Korean phonology is the disappearance of differences of vowel length in near-homophones. Until about less than three decades ago (as far as I can remember, by early 1980s), there was a clear difference in vowel length between near-homophones in Korean. As is observed from Table 1, all the near-homophones in Korean, in principle, used to have either a long vowel

Table 1

Homophone	Authentic pronunciation	Actual pronunciation
말(horse)	/mal/	/mal/
말(speech, tongue)	/ma:l/	/mal/
눈(eye)	/nun/	/nun/
눈(snow)	/nu:n/	/nun/
밤(night)	/bam/	/bam/
밤(chestnut)	/ba:m/	/bam/

or a short vowel as a clue to distinguish them from each other. I still remember that my elementary school teacher of my first grade used to stress the importance of pronouncing the vowel lengths of near-homophones correctly. This difference in vowel length for near-homophones was regarded as a very important part of Korean phonology. But this distinction disappeared somehow by the mid eighties and completely disappeared by the end of the late eighties. No doubt, there are still some Koreans who distinguish near-homophones by pronouncing the length of the vowels of them either long or short but they do it unconsciously and habitually when they do so. As a native speaker of Korean, it is my firm belief that nowadays there are very few Koreans who, upon hearing the mid-vowel of nun /nu:n/ meaning *snow* being pronounced as short vowel /u/, will correct him to pronounce the vowel of this word longer to make the word /nu:n/ distinguishable from its near-homophone nun/nun/ meaning ‘eye’.

This is also true of bam which means either *chestnut* or *night*. No Korean will ever mistakenly understand /ba:m/ ‘chestnut’, whose vowel used to be long, as /bam/ ‘night’, when somebody pronounces the vowel of the word short in the following sentence

- (1) Ku bam eun massitta
 Det Noun Nom suffix Adj
 “The chestnut is delicious.”

Then, what has caused this distinction in vowel length in near-homophones to disappear in Korean? There are no clear explanations for this vowel shortening. But still, it seems that there is some plausible reason for this phenomenon. The simplest and most persuasive reason seems to be that the difference in the vowel length was not crucial in distinguishing the meanings of a pair of this type of near-homophones for Korean speakers. Unquestionably, the most important role of vowel length difference in the near-homophones was that of distinguishing the different meanings of near-homophones. But, indeed, contextual information has also enabled native Korean speakers to distinguish the meanings of near-homophones correctly regardless of whether the vowel length distinction is present or not in

the near-homophones. In other words, Korean speakers still can rely upon the contextual information of a sentence to guess the meanings of homophones and near-homophones correctly. And more importantly, they have no difficulty in doing this task. In fact, nowadays, it is entirely the contexts that Korean speakers refer to in order to distinguish the meanings of homophones and near-homophones correctly.

In this sense, I assume that the presence of the distinction of vowel length in near-homophones must have been trivial and useless for most Korean speakers and finally disappeared. In short, the vowel length difference lost its usefulness or markedness as a criterion for distinguishing near-homophones semantically. I would call this disappearance of vowel length difference a ‘leveling phenomenon’ in the phonology of Korean. Two lexically identical words that used to be distinguished solely by the length of their mid-vowels lost the difference in the vowel length and came to be distinguished by the contexts in which they appear.

2.2 *The merger of different final consonants into one consonant, another leveling in Korean phonology*

Another important phonological phenomenon which has occurred in Korean is the merger of fricative and affricate consonants into a single fricative in word-final position. This change may sound vague but it will become clear as I explain about this phenomenon. Like many other languages, Korean has many one-syllable words which have CVC syllable structure and many words of this type only differ either in the initial or in the final single consonant. The case in question is words that have CVC structure and differ in the final consonant. Column A in Table 2 provides some words of this type in Korean. Phonologically, the three words in column A are distinguished from one another by the different final consonants. One interesting phenomenon that occurs in these words is that the final consonants of these words are pronounced identically as [t] when the words are pronounced in isolation. This phenomenon is called ‘coda neutralization’. But when the words are combined with a suffix that has a vowel in its initial position, the phonological values of the different final consonants are recognized and the final consonants begin to be pronounced as they are

Table 2

A. Phonetic Representation	B. Phonetic Representation in isolation	C. Pronunciations when combined with suffixes ‘i’ ‘ul’ ‘un’	D. Pronunciation Leveled
/bich/ (light)	/bit/	/bichi/, /bichun/, /bichul/	/bisi/, /bisun/, /bisul/
/biz/ (debt)	/bit/	/bizi/, /bizun/, /bizul/	/bisi/, /bisun/, /bisul/
/bis/ (comb)	/bit/	/bisi/, /bisun/, /bisul/	/bisi/, /bisun/, /bisul/

supposed to be pronounced phonologically. But this does not happen when the words are combined with a consonant-initial suffix. So the first word ‘*bich*’ in Column A at Table 2, when combined with ‘*ul*’ the accusative suffix, is pronounced as [bichul] and the second word [biz] as [bizul]. This phenomenon is an important phonological rule in Korean phonology. But this rule seems to be more and more neglected. The different final consonants of the words: [bich], [biz], [bis] at Table 2 are becoming more and more frequently

pronounced by Koreans identically as [s] when they have a following suffix that has a vowel at its initial position. Before I planned to write this paper, I interviewed several Korean native speakers to see how they pronounce these words with vowel-initial suffixes. The results show that among the Koreans interviewed most of the subjects who are over thirties pronounced these words with vowel-initial suffixes correctly. But, younger Koreans, most of whom were in their early twenties did not pronounce these words with vowel-initial suffixes correctly and showed tendency to pronounce the final consonant as [s] in all three words.

This result needs further investigation and needs more experiments with more subjects to generalize the finding. But one thing is somewhat clear from this result. This phenomenon seems to have happened because [s] is the easiest sound to pronounce. I assume that this phenomenon is ongoing among many young Korean people, especially Korean people under the age of thirty.

Actually, this merger of final consonants into [s] seems to be a fairly recent phenomenon because many Korean people of my age were still aware of these differences during high school days. Nevertheless, nowadays it seems to be increasingly becoming the case that Korean people distinguish what is meant by [bich], [biz] or [bis] solely from the context of the sentences in which these words appear. Obviously, this is another case of phonological leveling.

2.3. Consonant cluster reduction

The third phenomenon that is occurring in the phonology of Korean is consonant cluster reduction. I have to say that this phenomenon is in its initial stage but still in progress. Looking at the table closely will help to understand what I mean by this terminology.

Table 3

Phonetic Description	Phonetic Description in isolation	Pronunciation when combined with vowel -initial suffix <i>ul</i>	Leveled Pronunciation
/hulg/ (soil)	/hug/	/hulgul/	/hugul/
/tag/(chicken)	/tag/	/tagul/	/tagul/

Look at the word *hulg* 'soil' in the table for this case. This word consists of one syllable structures and the final consonant cluster has two consonants. In principle, the first consonant of this final consonant cluster is omitted in pronunciation and only the second consonant is pronounced when the word *hulg* is pronounced alone. But when the word is followed by a vowel-initial suffix, the value of the first consonant of the consonant cluster is recognized and the first consonant is pronounced. About two decade ago, this principle was regarded as the standard way of pronouncing this type of words that have a CVCC type syllable in Korean. But this principle has begun to change, too. Some of this type of words began to be pronounced differently.

As shown in the table, *hulg* and the suffix *ul* have to be pronounced as [hulgul]. But almost all Korean people pronounce this word and the suffix as [hugul]. The same phenomenon has also happened to *tagul*. Indeed, the pronunciation of *tagul* as [tagul] was so old and has been persistent that most Korean people do not know that the first consonant [l] is deleted.

This phenomenon has not advanced far yet and is in its initial stage. But unarguably this phenomenon has started in Korean. Simply a consonant in word internal position which has a following consonant and which used to be pronounced in certain environments is becoming

less and less pronounced these days. The most adequate explanation for this phenomenon seems to be the tendency towards the ease of articulation. Surely, this seems to have been triggered by Korean people's tendency towards the ease of articulation. Actually, this is not a phenomenon limited to Korean. There are many other languages that show the same phenomenon. Crosslinguistically, it is quite common that a consonant is deleted from consonant clusters.

2 Conclusion

As I have illustrated so far, the possible reason behind the three phonological changes is the tendency towards ease of articulation. This is shown in the three changes. In near-homophones in Korean, the mid-vowels tend to be shortened rather than lengthened. Needless to say, short vowel requires less airflow than long vowels, which means that short vowels are easier to articulate than long vowels. The merger of different final consonants into one consonant can also be explained in this sense. The final consonants which should not undergo coda neutralization before a vowel tend to be pronounced as one single consonant [s].

Lastly, consonant cluster reduction which has been claimed to exist in Korean in this paper also supports the claim that Korean is experiencing the tendency towards ease of articulation.

Appendix A. Loss of vowel length distinction in minimal pairs

(Data from the New Korean Dictionary published by Yang Ju dong in 1968)

Minimal pairs (meaning)	Authentic pronunciation	Actual pronunciation
말(horse)	[mal]	[mal]
말(speech)	[ma:l]	[mal]
눈(eye)	[nun]	[nun]
눈(snow)	[nu:n]	[nun]
밤(night)	[bam]	[bam]
밤(chestnut)	[ba:m]	[bam]
벌(punishment)	[bʌl]	[bʌl]
벌(bee)	[bʌ:l]	[bʌl]
창(spear)	[čaŋ]	[čaŋ]
창(Korean style singing)	[ča:ŋ]	[čaŋ]
발(foot)	[bal]	[bal]
발(blind curtain)	[ba:l]	[bal]
천(thousand)	[čʌn]	[čʌn]
천(cloth)	[čʌ:n]	[čʌn]
일(one)	[il]	[il]
일(work)	[i:l]	[il]
병(bottle)	[byuŋ]	[byuŋ]
병(disease)	[byu:ŋ]	[byuŋ]
배(ship)	[bæ]	[bæ]
배(double)	[bæ:]	[bæ]

Appendix B. Merger of fricative or affricate consonants into one single consonant

A. Phonological Representation	B. Pronunciation in isolation	C. Pronunciations with suffixes <i>i, un, ul</i>	D. Recent Pronunciations with the suffixes
빛/bič/ (light)	[bit]	[biči], [bičun], [bičul]	[bisi], [bisun], [bisul]
빚/biz/ (debt)	[bit]	[bizi], [bizun], [bizul]	[bisi], [bisun], [bisul]
빗/bis/ (comb)	[bit]	[bisi], [bisun], [bisul]	[bisi], [bisun], [bisul]
낫/nač/ (face)	[nat]	[nači], [načun], [načul]	[nasi], [nasun], [nasul]
낮/naz/ (daytime)	[nat]	[nazi], [nazun], [nazul]	[nasi], [nasun], [nasul]
낫/nas/ (sickle)	[nat]	[nasi], [nasun], [nasul]	[nasi], [nasun], [nasul]

References

- Yip, Moira. (1988). *The obligatory contour principle and phonological rules: A loss of Identity*, *Linguistic Inquiry* 19. 65-100.
- David Odden. (1993). *Introducing Phonology*, Cambridge University Press.
- R. L. Trask. (1996). *Historical Linguistics*, Oxford University Press.
- Seok Chae Rhee. (1997). *Release vs. nonrelease distinction in phonology: Comparison between Korean and Hindi*, University of Illinois at Urbana-Champaign.
- Oksook, Park. (2002). *A gesture-based account of consonant patterns in Korean*, Ph.D Dissertation, Michigan State University.

The effect of word-frequency on consonant gradation in Canadian-Finnish bilingual speech

Pauliina Saarinen

University of Victoria
pauliina@uvic.ca

ABSTRACT

This paper investigates the effects of word-frequency on application of consonant gradation in non-native Finnish speech. Based on the assumption that the same processes that shape native speech are at work also in non-native speech, it is hypothesized that a non-native speaker should produce a more native-like output with frequent lexical items. An experiment was designed to test the hypothesis. Two separate analyses were conducted. In one, the effect of word-frequency, as defined by a Finnish frequency-corpus, was considered and, in the other, the effect of word-familiarity was examined. In the former analysis, word-frequency was found not to have a significant effect on whether or not gradation applies. However in the latter analysis, word-familiarity, defined as individual frequency, was found to have effect on application of gradation. Unfamiliar words were less likely to undergo gradation than familiar words. The findings support the prediction that loss of gradation affects least frequent words first by analogical leveling. It is argued that loss of gradation is a means to reduce grammatical complexity.

Keywords: Finnish; consonant gradation; variation; frequency; word-familiarity.

1 Introduction

In literature on usage-based grammar, it has been established that human language is an outcome of an individual's cognitive organization of linguistic experience (Pierrehumbert 2001; Bybee 2005). The mind's capacity to generalize, discern patterns and build schemas from the accumulated linguistic information is central to the concept of human endowment for language. Memory has an astonishing ability to keep record of one's encounters with word forms and grammatical structures. Frequently encountered patterns become conventionalized in the speaker's grammar, while less frequent patterns do not (Bybee 2005). This individual linguistic experience is evidenced in a speaker's phonetic output as speaker grammar (Pierrehumbert 2000). Naturally, processes which shape speaker grammar in the first language are also at work in non-dominant language. This paper examines the effects of

lexical frequency in non-dominant¹ language, in which the idiosyncratic linguistic experience is even more pronounced. Since word-frequency has been found to affect the shape of words and word strings stored in speakers' mental lexicons (e.g. Hooper 1976; Bybee 2002; Phillips 1984), non-dominant speaker grammar should also exemplify these frequency effects. For example, phonetic change in native speech has been found to progress more quickly in high-frequency items, which typically is evidenced as reductive changes (Bybee 2001; Krug 1998). Like any motor activity, speech becomes more fluid when repeated often (Boyland 1996, in Bybee 2001). With a lexicon less extensive than that of a native speaker and limited exposure to native-like language, a non-dominant speaker should therefore produce more native-like output with frequent lexical items. This hypothesis was tested with the production of consonant gradation in the speech of a non-dominant speaker of Finnish. An experiment was designed to answer if the variance, i.e., the loss of gradation (henceforth GL), which was observed in the subject's speech, is related to word-frequency or not. Word-frequency, as defined by written Finnish word-frequency corpora, had no effect on application of consonant gradation. A relatively high number of standard forms were attested regardless of the frequency of the words. However, when the same data was analyzed in respect to *word-familiarity*, which is defined as a speaker's individual frequency, consonant gradation was found to apply to familiar words significantly more often than to unfamiliar ones. It is argued that *word-familiarity*, rather than word-frequency, accounts for the idiosyncratic nature of mental lexicons and should be taken as a measure of frequency for the individual. As such, results support the prediction that least frequent words are affected first by analogical leveling.

2 Background

In the debate over the diffusion of sound change through the lexicon, the Neogrammarian view has dominated until very recently. According to this view, diachronic sound change is regular, affecting the whole lexicon whenever the phonetic environment is encountered (Phillips 1984; Bybee 2002). However, already in 1885, Schuchardt observed that sound change does not necessarily diffuse through the lexicon at once, but some lexical items might be affected before others:

“The greater or lesser frequency in the use of individual words that plays such a prominent role in analogical formation is also of great importance for their phonetic transformation, not within rather small differences, but within significant ones. Rarely used words drag behind; very frequently used ones hurry ahead. Exceptions to the sound laws are formed in both groups.”(58) [in Bybee 2002, translated version found in Venneman & Wilbur (1972) Schuchardt, the Neogrammarians and the Transformational Theory of Phonological Change. Frankfurt: Athenaum]

¹ Non-dominant language in this paper refers to a language spoken by a person whose dominant language is other than Finnish. The participant was born in Canada, acquired Finnish as the first language at home, and speaks English as a dominant language.

He intuited that frequently used lexical items change faster than less frequently used items. Several studies (Bybee 2000; Jurafsky et al. 2001, and many others) have proven him correct. The next section looks at this evidence more closely and shows that diffusion of sound change through lexicon can indeed be gradual, not only lexically but also phonetically, and that it may progress in two directions, affecting either frequent or infrequent items first. Frequent items, having more use by numerous people, exhibit more innovative pronunciations overall, which renders these lexical items more prone to sound change. The Neogrammarian view is further challenged by the discovery that the gradualness does not only affect lexical items, but also individual segments (Loziewicz 1992). Phillips (1984, 2001) went on to refine the hypothesis that the type of sound changes can be used as a diagnostic for the direction of diffusion of sound change.

2.1 *The two directions of sound change*

2.1.1 Sound change affecting *frequent items* first

Anybody learning a new language can attest to the fact that, with practice, articulation requires less and less effort and that speech gestures become smaller and smoother while the message gets clearer. High frequency therefore has a reductive effect on both articulatory gestures as well as the shape of words and word strings, in non-native or native speech alike. Several studies have recorded that phonetic reduction, stemming from automation of speech, evidences itself as lenition, deletion, or neutralization and, thus, affects frequently used words or phrases first (Hooper 1976; Bybee 2001, 2002, 2005; Phillips 1984). Less frequently used words and phrases are more resistant to change. They may change at a slower pace or retain their full phonetic form. Among such studies is Fidelholtz's (1975) investigation of English vowel reduction in initial syllables of words, which are stressed on the second syllable. He discovered that the more frequent *mistake* has a reduced vowel /ə/ in its first syllable, while the less frequent *mistook* has a full vowel /ʊ/. The more common word *astronomy* has a /ə/ in the initial syllable, while infrequent *gastronomy* has an unreduced /æ/. Hooper (1976) also found that the medial /ə/ in frequent words such as *nursery*, *celery* and *memory* is deleted more often than it is in less frequent *cursor*, *artillery* and *armory*. Deletion is interpreted as stemming from well-rehearsed neuro-motor routines in frequent lexical items (Mackay 1978, in Phillips 1984). Easing of articulation is arguably also behind the deletion of English final /t/ and /d/ following a consonant; they are deleted more often in high-frequency words (Bybee 2002; Jurafsky et al. 2001). Several studies (Browman et al. 1992, in Bybee 2002; Mowrey et al. 1995) have found that speech gestures tend to overlap more due to anticipatory articulation. In English, the consonants following a homorganic nasal, like in *bomb* or *gang*, are deleted systematically, making [mb] or [ng] clusters non-existent in the language. The same erosion may be working on /nd/, as in *grand* (Bybee 2002). Thus, articulatory gestures deemed unnecessary or extreme become smaller in magnitude or are deleted altogether (Mackay 1978, in Phillips 1984). According to Phillips (1984), reductive sound changes of the kind discussed above have physiological motivations due to high-frequency use.

As shown above, sound change can be lexically gradual. It may work its way through the lexicon, eventually affecting all the eligible words. Alternatively, it may never be complete due to idiosyncrasies in frequency of lexemes in individual speakers (Bybee 2002, footnote

1). Sound change in progress is often observable in having two or more competing pronunciations for a word (Phillips 1984, 320), but when the sound change does happen, it is taken to be an abrupt replacement of a phoneme with another one (Labov 1994: 542). However, this may not always be case. Losiewicz (1992) found evidence that sound change may also be phonetically gradual. The English monomorphemic final /t/ and /d/, as in *just*, or *child*, which are prone to deletion (i.e. are in the context for deletion) are shorter than the /t/ and /d/ of the regular past tense. She also found that the duration of the regular past tense /t/ and /d/ is longer in low-frequency verbs than in verbs of high-frequency (ibid.) The findings are supported by the fact that in low-frequency verbs the regular past tense endings are very unlikely to be deleted and, conversely, more prone to deletion in high-frequency verbs (Bybee 2000). Since the stops are in the context for deletion in high-frequency verbs, their duration is also shorter. The findings indicate that the duration of a segment may decrease first before it is completely deleted, thus providing evidence for phonetic gradualness of sound change.

2.1.2 Sound change affecting *infrequent items* first

This section presents examples of frequency effect progressing in the opposite direction, affecting infrequent items first and discusses possible causes for it. Unlike the cases presented in the section above, infrequent items should be more resistant to physiological sound changes to ease articulation, as they do not benefit from rehearsal to the same extent. Thus, sound changes affecting the least frequent items first should have other impetus. Phillips (1984) proposes that sound changes of this sort have cognitive reasons.

Hooper (1976) demonstrated how infrequent irregular verbs, such as *weep* in the past tense, tend to regularize into *weaped*, while frequent verbs, such as *keep*, retain their irregular paradigms. Although irregular, the word *keep* is so ingrained in the speakers' lexicons thanks to its high-frequency use, that *keeped* would sound ungrammatical to a native ear. Infrequent irregular verbs, on the other hand, do not get established in the speakers' grammar due to less use and, thus, are likely to undergo regularization. Exceptional patterns are hard to keep in mind, in which case the stronger tendency in the language wins over the weaker one, a process also known as *analogical leveling*.

Another example of sound change affecting infrequent items comes from Phillips (1984). The Old English diphthong *eo* changed into a mid front rounded vowel *ö* with both a long and a short version in use in the 11th and 12th centuries. In some dialects they were retained until the 14th century, but in Lincolnshire, they changed on to become unrounded and merged with *e(:)*. Interestingly, Ormulum, a manuscript written around 1200AD, captures the change in progress, showing two different spellings for one word, such as *deop* and *dep* for 'deep'. Phillips (Ibid.) discovered that in nouns and verbs, the low-frequency words were more likely to have the innovative spelling with the unrounded vowel. There were no other front rounded vowels in English at the time, so the majority of words would have front vowels unrounded. Thus, *ö* would have had to be learned as a special case. However, front rounded vowels are challenging for children to perceive and learn, and as a result, they are usually acquired later than unrounded vowels (Gilbert et al. 1975, in Bybee 2002). Arguably then, high-frequency use would have aided the acquisition of the special case *ö*, and with less frequent words

children opted for the unrounded equivalent, a pattern that was becoming more natural to them (*ibid.*).

So far, we have established that sound change may be both lexically and phonetically gradual and sometimes it never affects the whole lexicon. These findings suggest that phonetic detail is stored in the lexicon, thus challenging generative views to phonetics and phonology. According to the latter, phonetic detail is applied on an item by means of rules and constraints after its retrieval from the lexicon. The phonetic shape of words is strictly the outcome of what these rules and constraints dictate, treating all eligible words in the same way. However, word-frequency does not fit in the workings of these models although, as shown by the examples presented above, it conditions allophony. Thus, we need an approach, which is suited in conceptualization of word-frequency, another force behind variation in phonetic outcome.

2.2 *Exemplar Dynamics*

This model, as presented in Pierrehumbert (2001), posits that the memory stores an individual's accumulated linguistic experience as exemplars. Linguistic experience means an individual's encounters with full word forms, morphemes, phonemes, word-strings, or prosodic information of which a memory is formed. Whatever category the memory belongs to, it merges with an old one if the difference between the two is too small to notice. Conversely, a token with a noticeable difference is stored in close proximity as a separate category. The distance between the tokens represents similarity or dissimilarity between them. Thus, clusters of related memories emerge. A category label representing the whole cluster is drawn from the essential parameters of the exemplars stored in the mnemonic assemblage. Each category represents parameter space where the properties of a new token are determined and which determines the position of it within the cluster. An exemplar gains strength through activation, i.e., recency and frequency of use. The more recently and frequently a token is activated, the higher its activation level is. Activation level of tokens already stored in the category affect the categorization of a new token entering the same cluster; a new token is more likely to be analyzed as another example of a previously stored token with a high activation level. The number of tokens and their strength comprise the forces that fix the position of a new token in the parameter space. An exemplar may be simultaneously associated with multiple categories dedicated to different aspects of linguistic information. Sparse categories of exemplars represent clusters that are called for less frequently. Similarly, they receive fewer "hits", so their strength tends to be less. These categories are more prone to be forgotten. Exemplar neighborhoods overlap at the outer boundary, allowing room for dialectal or random speaker variation.

The Exemplar model makes it possible for a memory that is deviant from the targeted form to gain strength through frequent or recent activation and get selected. A situation like this could arise in non-dominant speech in which an individual's idiosyncratic grammar is well established. Sociolinguistic contexts for non-dominant speech often reinforce grammar that is deviant from the standard. Moreover, it is the person him or herself whom one hears most often, thereby perpetuating deviant forms (S. Bird, p.c., February 18, 2007). Indeed, in the next paragraphs this model is applied to this very situation, examining the application of consonant gradation in non-dominant Finnish speech. However, before presenting the

experiment in section 3, consonant gradation in Standard Finnish is first discussed in more detail in section 2.2. and variation in its application in non-dominant speech in Section 2.3.. Section 4 presents the results, section 5 the discussion and, finally, section 6 concludes this exposition.

2.3 Consonant Gradation in Finnish²

Consonant gradation is a form of morphophonological process in which the alternation of stem consonants is triggered by inflectional and derivational suffixation. It is a relatively commonly encountered phenomenon in Finnish; of the 1000 most frequent words, a third is subject to consonant gradation. It affects voiceless stops /p, t, k/ when they are preceded by a vowel or liquids. Voiced stops /b, g/ are affected in some slang words. Gradation evidences itself as an alternation of either the length of the stop, i.e. quantitative, as in *rätti-rätin* 'rag-GEN.SG', or the quality of it, as in *koti-kodin* 'home-GEN.SG', and in the case of single stop /t/, its deletion, as in *näky-näyn* 'sight-GEN.SG'. Most frequently affected consonant is /t/, while /p/ is affected least frequently. Table 1 presents consonants subject to quantitative gradation, i.e., shortening or lengthening, and Table 2 those subject to qualitative, leniting or strengthening, gradation.

Table 1

Quantitative Gradation; shortening or lengthening

1	pp~p	tt~t	kk~k
2	mpp~mp	ntt~nt	ŋkk~ŋk
3	lpp~lp	ltt~lt	lkk~lk
4	rpp~rp	rtt~rt	rkk~rk
5	bb~b		gg~g

Table 2

Qualitative Gradation; lenition or strengthening

6	mp~mm	nt~nn	ŋk~ŋŋ
7	lp~lv	lt~ll	lk~llj
8	rp~rv	rt~rr	rk~r/rj
9		ht~hd	hk~h/hj
10	p~v	t~d	k~ - /v

Gradation has two realizations, STRONG or WEAK. Gradation can be *direct* or *indirect* (i.e., *reverse*) depending on whether the basic form is STRONG or WEAK. In (1), *kukka-kukan* 'flower.NOM.SG-flower.GEN.SG', exemplifies direct gradation since the geminate, STRONG form, is also the basic form. The inflected form is WEAK, gradated form. Conversely, a situation where WEAK form is the basic form is called reverse gradation, as in (2). In this case, WEAK form is the basic form.

² From Hakulinen et al. (2004).

(1) Direct Gradation (STRONG-WEAK)

- a. kuk.ka-ku.kan ‘flower.NOM.SG-flower.GEN.SG’
 b. kier.tää-kier.rän ‘to go around- to go around.1SG’

(2) Reverse Gradation (WEAK-STRONG)

- a. ri.kas:rik.kaan ‘rich- rich.GEN.SG’
 b. ker.rata:ker.taan ‘to review-to review.1SG’

Generally, STRONG variant precedes an open syllable with no coda consonant, while WEAK form is usually found preceding a closed syllable. There are many exceptions to this rule, as in (2); STRONG forms are found preceding closed syllables.

2.4 Variation in Consonant Gradation in non-dominant Finnish speech

Similarities in the process of acquisition of first and second language (Lightbown & Spada 1999) justify the presupposition that the same pressures that shape speech in a dominant language are at work in non-dominant language. It follows that the effects of word-frequency should be observable also in non-dominant speech. This premise led to the present study where the language of a non-dominant speaker of Finnish is examined in respect to the application of consonant gradation. The consultant, a first generation Canadian-born non-dominant speaker of Finnish, uses standard-like gradated forms with some words, while leaving other words ungradated altogether. Table 3 presents some examples of the observed variation.

Table 3

Variation in Consonant Gradation in Canadian-Finnish

Direct Gradation	(Basic form (SF)) Gradated form (SF)	Non-dominant Finnish	Gradation	Gloss
nt:nn	(ranta) rannalla	rannalla	yes	“on the beach”
	(englanti) englanniksi	englantiksi	no	“in English”
ŋk:ŋŋ	(helsinki) helsinkiissä	helsinkiissä	no	“in Helsinki”
lp:lv	(halpa) halvalla	halpalla	no	“at a cheap price”
rt:rr	(kerta) kerran	kerta	no	“one time”
	(siirtyä) siirryn	siirryn	yes	“I move (aside)”

SF=Standard Finnish

Loss of gradation (GL) is unlikely to stem from phonetic motivations to ease articulation. In many cases, applying gradation would have that effect, as it tends to weaken the closure of stops. In cases where it produces a geminate, the consonant is just longer and not necessarily

doubly articulated (Hakulinen et al. 2004, 66). As seen in Table 3, with *nt:nn*³ gradation, the participant produced the standard form in one word (*rannalla*) and a non-standard form in another (*englantiksi*) although the consonants involved are the same in both instances. Since GL may occur in different words containing the same consonant combinations, positing lexical motivation for GL is particularly compelling. Could frequency be the motivation behind the variation in non-dominant Finnish speech? An experiment was set up to answer whether *loss of gradation (GL)* in non-dominant Finnish is affected by word-frequency. If so, two possibilities exist. One is that GL affects frequent items first, and the other is that less frequent words show GL first. It is predicted that GL is correlated with word-frequency, and that due to limited exposure to standard language, a non-native speaker produces more native-like output with frequent lexical items. In other words, the participant is expected to gradate frequent words more successfully than infrequent ones thanks to more repetition and exposure to them.

3 Methodology

3.1 Subject

One Canadian-born Finnish speaker participated in this study. Now 71, she speaks English as her dominant language and Finnish, which she acquired from her immigrant parents as L1. As a child, she was always spoken to in Finnish at home. All her education was in English. She visits relatives and friends in Finland about every five or six years, spending approximately two months in the country on each trip. At home, she does not speak Finnish regularly. She meets her friends and acquaintances from the Finnish community about once a month with whom she speaks Finnish. She reads and understands written Finnish in cards and letters received from her relatives in Finland.

3.2 Tokens

The CSC, or the Finnish Information Technology center⁴, a corpus listing Finnish words in newspaper texts according to descending frequency was used to compile two word lists. The test words were to exhibit direct consonant gradation only and the following frequency requirements. The tokens for the list representing frequently used words of the corpus were to be among the first 1000 most frequent words. 47 tokens were chosen. The frequency of the selected words ranged from 1315 to 136 times in every million words. The tokens

³ According to Hakulinen et al. (2004), *nt~nn* alternation is the second most frequent gradation type with 1432 instances in *Perussanakirja*, a comprehensive dictionary, after *tt~t* alternation which has approximately 2980 instances. *kk~k* alternation comes third with about 1220 instances (73).

⁴ The corpus is accessible at <http://www.csc.fi/kielipankki/aineistot/ssts/frq1/phtml>

representing less common words were to be among 3000 or less frequent words. 41 tokens were chosen for this list⁵. Their frequency ranged between 35 and 11 times in every million words. Distinction between the type of gradation, whether quantitative or qualitative, was not made, and the two lists compiled contained both types of gradations. Similarly, the words on the lists included many types of consonant combinations to ensure a big enough sample within the frequency requirements described above and to gain knowledge of the overall pattern of variation. Table 4 lists the consonant combinations included. The gradated forms of the 88 tokens were to be elicited from the speaker.

Table 4

Consonant Combinations used in the study

Direct Gradation (STRONG~WEAK)	
Quantitative (shortening)	Qualitative (lenition)
pp~p	mp~mm
tt~t	nt~nn
kk~k	ŋk~ŋŋ
	lt~ll
	lk~l
	lk~lj
	rt~rr
	rk~r
	ht~hd
	p~v
	t~d
	k~-

Table 5

Sample of the elicited words from the list representing high-frequency words

Direct Gradation	Standard Finnish basic:gradated	Frequency/million Words (Rank)	Gloss/phrase elicited
kk~k	viikko~viikon	386 (100.)	"for a week"
	tarkka~tarkasti	142 (856.)	"accurately"
	kirkko~kirkossa	286 (411.)	"in the church"
nt~nn	ranta~rannalla	140 (872.)	"on the beach"
	syntyä~synnyin	588 (157.)	"I was born in Canada."
	tuntea~tunnen	477 (219.)	"I know Matti."
	asunto~asunnossa	246 (483.)	"in an apartment"
	palkinto~palkinnon	150 (819.)	"to win the 1 st prize"
	sekunti~sekunnissa	166 (743.)	"I'll be back in a second."

⁵ Limiting the study to direct gradation only produced a smaller number of infrequent than frequent test tokens.

Elicitation of tokens was done by prompting the participant for Finnish translations for English words or phrases which were formulated in such a way that the targeted form would have to be used in Standard Finnish. Table 5 provides an example of the word lists used in the experiment.

3.3 *Experiment*

The recording took place at the participant's home in Courtenay, British Columbia in February 2006. The participant was asked to provide a Finnish translation of the words or phrases provided. The participant did not see the word lists. The researcher gave the basic form of a word in case the participant used a synonym rather than the targeted word. The session was recorded using a Sony MZ-B10 portable mini-disc recorder and a Sony EMC-T115 lapel microphone. The data was later transferred onto a CD using "Audacity"-software.

3.4 *Analysis*

Of the 88 words, 6 were discarded due to an error in elicitation or unfamiliarity with a word and thus yielding no translation. All in all 82 words, 44 frequent and 38 infrequent, were analyzed for their correctness, i.e., whether the word form given by the participant contained a gradated form or not. The data was subjected to two separate analyses with respect to two independent variables, word-frequency in the first analysis and word-familiarity in the second one. For both the variables, the occurrence of standard and variant forms was recorded. The rationale for proposing word-familiarity as a variable is that frequent words for native speakers, as represented by word-frequency corpora, do not necessarily correspond to frequent words for individuals, particularly for those who speak a language non-dominantly. Thus, a set of criteria was established to test the subject's familiarity with each token on the two lists. A word was considered familiar if the participant produced an immediate translation without the researcher giving the basic form. Similarly, the word was considered *familiar* if the participant offered a conversational cue, such as "yes" or "uh-huh" which was taken to mean that the word prompted is a familiar one. Conversely, a word was considered *unfamiliar* if the participant, regardless whether or not a conversational cue accompanied the answer, did not come up with a prompt translation, or if the participant hedged upon answering, or produced several forms before settling on one form as an answer. Words for which no answer was given were discarded. The researcher sorted the tokens one by one into familiar and unfamiliar ones using a test-retest-retest method; the tokens were evaluated against the criteria described above three separate times comparing the latest results with previous results (Seliger & Shohamy 2005, 186). This way, 61 familiar and 21 unfamiliar words were found. Then, the occurrence of standard and variant forms was recorded.

4 Results

Table 6 shows the distribution of standard and variant forms based on word-frequency. As can be seen from the table, a relatively high number of standard forms were attested on both lists regardless of their frequency. The participant produced standard forms in 61.36% of the frequent tokens and 78.97% of the infrequent tokens, showing higher number of standard forms with infrequent items than with frequent items.

Table 6

Distribution of standard and variant forms based on **word-frequency**

Ranking	Standard (%)	Variant (%)	Total
<1000 (frequent)	27 (61.36%)	17 (38.64%)	44
>3000 (infrequent)	30 (78.95%)	8 (21.05%)	38
Total	57 (69.51%)	25 (30.49%)	82

Conversely, there were more non-standard forms with frequent items (38.64%) than with infrequent items (21.05%). The results prove the trend going in the opposite direction than initially predicted. However, this distribution of standard and variant forms based on word-frequency was found to be insignificant at the .05 level. Thus, it is concluded that word frequency, as defined by the word-frequency corpus, has no significant effect on GL.

Next, the data were subjected to the second analysis, this time using word-familiarity as the independent variable. The variable was evaluated against the criteria described above. Table 7 provides the results for the latter analysis.

Table 7

Distribution of standard and variant forms based on **familiarity**

	Standard (%)	Variant (%)	Total
Familiar	49 (80.3%)	12 (19.6%)	61
Unfamiliar	8 (38.09%)	13 (61.9%)	21
Total	57	25	82

This analysis produced statistically significant results ($\chi^2=13.15$, $p \leq 0.001$). Standard forms are considerably more frequent with familiar words than with unfamiliar words, 80.3% as opposed to 38.09%. In turn, the number of variant forms is higher (61.9%) with unfamiliar words than with familiar words (19.6%). The results indicate that there is a relationship between familiarity and GL. Implications of these findings are discussed in the next section.

5 Discussion

In the present study, it was hypothesized that due to limited exposure to standard language, a non-dominant speaker would produce more native-like output with frequent

lexical items. Thus, it was expected that a non-dominant speaker of Finnish would produce more standard-like gradation in commonly encountered words. Conversely, words that are heard or used less often would show more deviant forms. This presentiment was proven correct. However, the results indicate that the definition of word-frequency must be expanded to encompass the idiosyncratic linguistic knowledge that an individual possesses. Although word-frequency, as defined by frequency corpora, might be an approximation of the lexicon in a native-speaker population in general, arguably it does not reflect accurately the status of the lexicon in an individual. The discrepancy between population-wide and an individual's own frequencies is heightened in non-dominant speaker contexts. In its stead, *word-familiarity* is proposed as a measure to reflect idiosyncratic word-frequencies at the level of the individual.

5.1 *Word-familiarity*

The concept of word-familiarity, idiosyncratic word-frequency, is proposed to account for lexical experience an individual has accumulated. This experience is shaped by upbringing, occupation, social class, personal interests and such creating unique lexicons in each individual. Corpus-based word-frequency listings fall short in their ability to capture this variation. Moreover, the discrepancy between individual and language-wide frequencies is heightened in non-dominant language situations.

According to Pierrehumbert (2000, 10), it is the number of different examples of morphophonological alternations that establish a word relationship in the memory. It influences the extent to which it is cognitively real to the speaker. The more often the token is used, the more familiar the speaker/hearer becomes with it. A familiar lexical item triggers appropriate semantic associations reliably and reinforces the relationship between them. This cognitive reality is what word-familiarity represents. With perfectly familiar items, the language user is able to create messages that manifest target-like production in respect to semantics, pragmatics, syntax, and phonology. Anything less than that implies less than perfect acquisition. The activation of a less familiar word is unreliable, triggering fewer or no associations.

Word-familiarity, then, corresponds to word-frequency but reflects an individual's idiosyncratic lexicon, linguistic experience that one gains from exposure to language. Frequently encountered tokens benefit from more frequent feedback and, therefore, show more fluency. Low-frequency tokens, in turn, are less familiar or unfamiliar altogether, showing more variance due to imperfect learning. The participant was significantly more likely to produce standard-like gradation in familiar words, which were produced without delay and/or accompanied by a conversational cue. The words that showed GL were also likely to be accompanied by hedging, delayed answers and/or the lack of conversational cues and, thus, classified as unfamiliar. Familiar items are likely to have been heard and used more often, for which reason their gradated forms were also easier to maintain. Infrequent items, in turn, have not benefited from regular use and have remained less familiar or completely unfamiliar. Neither have their gradated forms received enough reinforcement for the participant to acquire them solidly. These results are interpreted to stem from the participant's limited exposure to standard Finnish; the participant's linguistic experience in

Finnish has been accumulated from infrequent and/or less than perfect feedback in immigrant setting.

Since word-familiarity increases through frequency and recency of use, it can be equated with the concept of *activation level* (Pierrehumbert 2001), discussed in section 2.1. The more recently and frequently an item is called upon, the more familiar the item is and the more reliably it gets activated. The outcome can therefore be expected to be highly idiosyncratic, just as the results show. Consequently, word-familiarity is a gradient continuum ranging from fully acquired familiar words with which the user manifests linguistic dexterity, to moderately familiar words whose activation is unreliable and which are prone to variance, to completely unknown words that remain beyond grammatical manipulation.

5.2 Analogical leveling

The results indicate that GL affects infrequent items first, suggesting cognitive motivations underlying the variation, as discussed in section 2.1.1. GL represents a type of regularization, where unexpected forms are replaced by a more basic pattern and, as such, resembles *analogical leveling*. As discussed earlier, it is interpreted to stem from cognitive motivations, ways of organizing linguistic information in the brain.

As seen in Table 8, the speaker opts for the stem found in the basic form instead of the gradated stem although the latter is standard.

Table 8

Analogical leveling in application of consonant gradation

Direct Gradation	(Basic form (SF)) Gradated form (SF)	Non-dominant Finnish	Gloss
lp:lv	(halpa) halvalla	halpalla	"at a cheap price"

This tendency was apparent across all lexical categories in the data. *Lauseopin arkisto*, a sentence archive for Standard Finnish, identifies the basic form as the most frequent form across the lexical categories (Hakulinen et al. 2004, 1180-1181). According to the archive, NOMINATIVE and GENITIVE are the two most frequent cases for nouns, occurring at the rate of 26,3% and 27,4% respectively. NOMINATIVE is by far the case most common for adjectives (32,2%), demonstratives (32,1%), and personal pronouns (47,7%). The frequency at which other cases are found in the same sentence archive is far less; INESSIVE is the most common case for nouns and demonstratives with 6,7% and 8,3% respectively, ILLATIVE for adjectives with 5,3%, and ALLATIVE with 7,3% for personal pronouns. For verbs, in turn, the basic form infinitive occurs at the rate of 55,4%. Of the case forms for infinitives, ILLATIVE is the most common with but occurs at a rate considerably lower than the basic form at 16,7%. The above percentages are collected in Table 9.

Table 9

Most frequent case forms in Standard Finnish (%) (Hakulinen et al. 2004)

	Nouns	Adjectives	Demonstrative Pronouns	Personal Pronouns	Verbs
NOM	26,3	32,2	32,1	47,7	
INE	6,7		8,3		
ILL		5,3			16,7
ALL				7,3	
Basic form (infinitive)					55,4

The high rates at which the basic forms, i.e., NOMINATIVE and infinitive, occur in standard language may explain the variation in the application of gradation in non-dominant speech. If the basic forms are statistically more common in Standard Finnish, a non-dominant learner would be more likely to have stored more instances of the basic form than the gradated form in the memory. Infrequent, less familiar categories would consist of fewer exemplars, but those would be more likely to contain the basic form consonant combinations due to their high frequency. Therefore, picking one exemplar from these less frequented categories would be likely to contain the basic form stem. Conversely, familiar frequently used exemplars would reside in categories with numerous closely related representatives. Among these exemplars, ones containing standard-like gradation would be well represented. Higher activation level overall in these commonly used categories provide the exemplars containing standard-like gradation with a higher probability to get selected.

As discussed in section 2.2, case suffixes and consonant gradation are intricately related in Finnish, for it is the suffixes that trigger gradation in the stem. See Table 10 for an example.

Table 10

Realization of consonant gradation in INESSIVE in Standard Finnish and non-dominant Finnish

Direct Gradation	(Basic form) Gradated form; INE; SF	Non-dominant Finnish	Gradation	Gloss
lk~l	(jalka) jalassa	jalassa	yes	“on the foot/feet”
ᵛk~ᵛᵛ	(kaupunki) kaupunkissa	kaupunkissa	no	“in the city”

SF= Standard Finnish

However, based on the results, it is likely that especially in non-dominant speech, case and gradation are subject to their respective frequencies, which dictate whether or not the gradation is present in the output. The participant produced phrases such as *jalassa* ‘on the foot/feet’ and *kaupunkissa* ‘in the city’. The former is a standard form with respect to both case and gradation. The latter is non-standard with respect to gradation. It is proposed that case and gradation are stored as a unit in the same exemplar for familiar and well-established

concepts⁶. However, less common stem-case combinations may be pieced together from one exemplar containing the case suffix and another containing the basic form of the word.

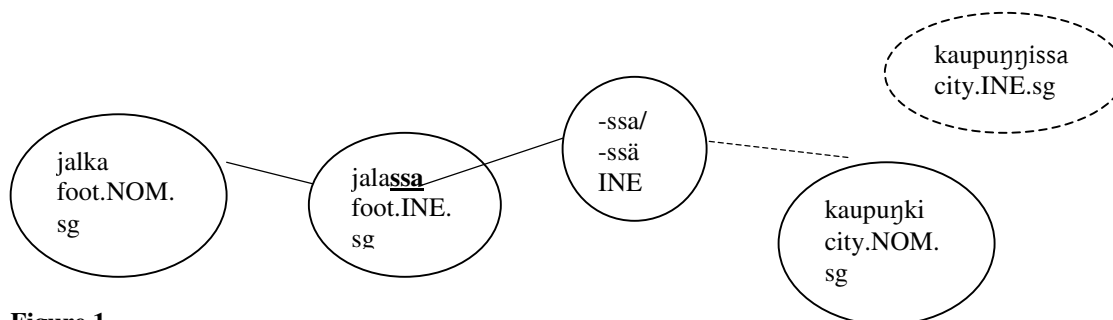

Figure 1

Exemplar associations in the mnemonic network.

This is demonstrated in Figure 1. Familiar concepts, such as *jalassa* ‘on the foot/feet’, are stored and processed as a unit and, thus, show standard gradation. *Jalassa* is associated with its base form *jalka* and the exemplar containing INESSIVE suffix, represented here with a solid line. INESSIVE, due to high-productivity, is assumed to also exist as a separate exemplar and to be added onto stems when needed, as with the phrase ‘in a city’. It consists of exemplars *kaupunki* and INESSIVE, shown with a dashed line. Since the phrase is pieced together from the exemplars that exist separately, gradation is not present in the output. The standard form *kaupungissa*, may also be stored as a unit close by but does not get selected due to its lower activation level, as represented by a dashed oval. The activation levels of the exemplars determine which ones get selected and, consequently, what properties are present in the output.

Analogical leveling is typically known as a phenomenon where a more complex process is replaced by another process, which is perceived as less complicated for the language user. GL resembles analogical leveling in that it regularizes complex grammar by replacing exceptional gradated forms with the most common form of a word, the basic form. Gradated forms are perceived as more complicated, even arbitrary from a point of view of a non-dominant speaker, unless they are well-established in the language. Unique in this regularization is that a non-process takes over a process. The basic form, the most frequent form in the language, overrides a process, consonant gradation. However, it achieves what analogical leveling achieves. It reduces grammatical complexity without risking comprehension. When frequencies of gradated forms in the memory are high enough, regularization ceases. Until then, when the memory fails with infrequent items, the pattern that is stronger in the language is chosen.

⁶ Slips of the tongue due to English interference, e.g., *lipset* for Finnish *huulet* ‘lips’ (huul-et, lip-PLU.NOM) provide evidence that morphology can indeed be lexicalized with the stem to represent a complete concept. The phenomenon is known as the Conserving Effect (Bybee 2005, 2007).

Of the two types of gradation, quantitative is perhaps more predictable than qualitative gradation. Quantitative gradation either shortens or lengthens the existing stem consonants keeping the quality of the consonant constant. On the other hand, qualitative gradation weakens or strengthens the obstruction of the consonant, changing the quality of it, for which reason a non-dominant speaker may perceive qualitative gradation more arbitrary. Acquisition and maintenance of the latter type is expected to be more difficult. Thus, in non-dominant speech, analogical leveling is predicted to cause basic form being used more often than the gradated form in words subject to more subtle qualitative gradation. However, this hypothesis remains to be a topic for future research.

6 Conclusion

From the results obtained from two separate analyses, it is concluded that application of consonant gradation in non-native Finnish as spoken by a second generation Finn as a non-dominant language is closely related to idiosyncratic word-frequency, i.e., word-familiarity. The first analysis considered if word-frequency, as defined by Finnish newspaper corpus, had a significant effect on application of consonant gradation in non-native speech. The results answer in the negative. The participant produced a relatively high number of standard gradation with both frequent and infrequent words. The second analysis, which in turn considered the effect of word-familiarity on application of consonant gradation, found significant results. The number of standard forms was significantly higher with familiar words than with unfamiliar words, while GL was considerably more likely in unfamiliar words than in familiar words. Less frequent items are more unfamiliar and regularized by analogical leveling, while frequent and thus more familiar items benefit from regular feedback showing more standard production. Therefore, it can be concluded that word-frequency is a relative concept that depends on an individual's personal linguistic experience, in native or non-native speech alike. In order to take this idiosyncratic nature of word-frequency into consideration, word-frequency should be defined on an individual basis.

Acknowledgments

I would like to thank Dr. Sonya Bird for her supervision and guidance during this project. This paper has greatly benefited from her insights and suggestions. I also want to thank Sunghwa Lee and Soo-Youn Ham who kindly peer-reviewed my original paper and gave me constructive comments. I also want to express my sincere gratitude to my consultant and friend M.P. for sharing her time and language with me.

Appendix A. Consonant Gradation Data: Frequency <1000

Direct Gradation	Standard Finnish basic:gradated form	Frequency/million words (number)	Non-dominant Finnish	Gloss
				“in “in the end”
pp:p	loppu:lopussa	653 (128.)	lopussa	
	helppo:helposti	253 (461.)	helposti	“easily”
k:j	poika:pojan	384 (294.)	pojan	“a boy’s (room)”
	aika:ajan	1315 (53.)	-	“for an hour”
tt:t	esittää:esitän	621 (141.)	esitän	“to present”
kk:k	viikko:viikon	386 (100.)	viikon	“for a week”
	tarkka:tarkasti	142 (856.)	tarkasti	“accurately”
	kirkko:kirkossa	286 (411.)	kirkon sisällä	“in the church”
nt:nn	ranta:rannalla	140 (872.)	rannalla	“on the beach”
	syntyä:synnyin	588 (157.)	syntyä	“I was born (in Canada)”
	tuntea:tunnen	477 (219.)	tunnen	“I know Matti.”
	asunto:asunnossa	246 (483.)	asunto	“in an apartment”
	palkinto:palkinnon	150 (819.)	palakinto	“to win the 1 st prize”
	sekunti:sekunnissa	166 (743.)	sekuntissa	“(I’ll be back) in a second”
	luonto:luonnossa	165 (748.)	luonnossa	“in the nature”
	kunto:kunnossa	328 (355.)	kunto	“(to be) in shape”
	myöntää:myönnän	385 (291.)	myönnän	“I admit”
	tunti:tunnissa	348 (339.)	tunnin	“in an hour”
	hinta:hinnat	440 (245.)	hinnat	“prices (are up)”
ŋk:ŋŋ	kaupunki:kaupungissa	1062 (70.)	kaupungissa	“in the city”
	Helsinki:Helsingissä	1133 (63.)	Helsingissä	“in Helsinki”
lt:ll	ilta:illa-n/-lla	231 (528.)	illan/illalla	“in the evening”
	valta:vallassa	164 (749.)	valtassa	“(a president) in power”
lk:l	jalka:jalassa	151 (818.)	jalassa	“(socks) on the feet”
lk:l̥j	jälki:jäljet	136 (904.)	jäljet	“(bear) tracks”
rt:rr	kertoa:kerron	1851 (30.)	kertoo	“I tell...”
	kerta:kerran	752 (113.)	kerta	“one time”
	siirtyä:siirryn	380 (297.)	siirryn	“I move (aside)”

rk:r	pyrkiä:pyrin	404 (280.)	pyrkin	“to apply (to school)”
	Turku:Turussa	768 (108.)	Turus	“in Turku”
ht:hd	ehtiä:ehdin	315 (376.)	ehtin	“I was in time for...”
	johto: johdossa	354 (332.)	johtos	“(a twist) in an electric cord”
p:v	apu:avusta	465 (226.)	apusta	“thanks for your help”
	luvata:lupaan	238 (503.)	luvaan	“I promise...”
	tapa:tavat	649 (130.)	tapa	“(good) manners”
t:d	äiti:äidille	244 (488.)	äitille (correct dialectal form)	“for mom”
	vaatia:vaadin	638 (135.)	vaadin	“I demand...”
	löytää:löydän	410 (276.)	löydän	“I find (old things)”
	sota:sodassa	301 (395.)	sodassa	“in the war”
	katu:kadulla	136 (905.)	kadulla	“(met Mari) on the street”
	pyytää:pyydän	198 (620.)	pyydän	“I ask for (more water)”
	koti:kodissa	299 (397.)	kodissa	“in a home”
k:-	tuki:tuen	384 (292.)	tukia	“you support your children”
	aikoa:aion	379 (299.)	-	“I’m going to...”
	hakea:haen	378 (230.)	hajen	“I pick Lisa up”
	lukea:luen	211 (586.)	lujen	“I read (in the evening.)”
k:v	luku:luvut	767 (109.)	-	“numbers”

Appendix B. Consonant Gradation Data: Frequency >3000

Direct Gradation	Standard Finnish basic/gradated form	Frequency/million words (number)	Non-dominant Finnish	Gloss
tt:t	rauhottaa:rauhoitin	34 (3031.)	rauhotin	“I calm (sb down)”
	valuutta:valuutat	34 (3079.)	valuutat	“currencies”
kk:k	leikki:leikit	34 (3010.)	leikit	“(children’s) games”
	rannikko:rannikolla	34 (3083.)	rannikolla	“on the coast”
	tupakka:tupakalla	33 (3101.)	tupakala	“having a cigarette”
	lenkki:lenkillä	31 (3330.)	lenkile	“having a walk”
mp:mm	lampi:lammessa	11 (4973.)	lammissa	“in the pond”
nt:nn	tuonti:tuonnit	35 (3009.)	tuontia	“imports”

	emäntä:emännälle	34 (3078.)	emänäle	"to the host"
	rinta:rinnassa	31 (3273.)	rinnassa	"in the chest"
	pyyntö:pyynnöt	31 (3284.)	pyyntöjä	"requests"
	Skotlanti:Skotlannissa	31 (3297.)	Skotlantissa	"in Scotland"
	uinti:uinnit	25 (3951.)	-	"swims (plu)"
	ravinto:ravinossa	25 (3974.)	ravinossa	"in nutrition"
	perintö:perinnöt	24 (4125.)	perintöjä	"inheritances"
ηk:ηη	kenkä:kenjät	33 (3116.)	kenjät	"shoes"
	runko:runnot	23 (4248.)	runnot	"tree trunks"
	sänky:sänjyssä	20 (4606.)	sänjyssä	"in bed"
lt:ll	kielto:kiellot	32(3208.)	kiellot	"denials (plu)"
	aalto:aallot	27 (3663)	aallot	waves (in a lake)
	puhaltaa:puhallan	31 (3306.)	puhallan	"I blow (in the soup)"
	huolto:huollossa	30 (3352.)	huollossa	"in (mom)'s care"
lk:l	polku:polulla	26 (3810.)	polulla	(a bear) on the trail"
lk:l̥j	polkea:poljen	21 (4499.)	polen (correct dialectal form)	"I pedal (a bike)"
ht:hd	kiirehtiä:kiirehdin	28 (3516.)	-	"I hurry"
hk:h	pyyhkiä:pyyhin	14 (6156.)	pyhin	"I wipe (the table.)"
p:v	tupa:tuvassa	14 (6184.)	tupassa	"in a farm house kitchen"
	repiä:revin	32 (3191.)	revin	"I tore (the letter.)"
	kipu:kivussa	34 (3043.)	kipua	"in pain"
	syöpä:syövät	27 (3701.)	syövät	"cancers"
t:d	paita:paidan	34 (3037.)	paidan	"(I bought) a shirt"
	latu:ladulla	34 (3074.)	ladulla	"on the ski trail"
	satu:sadun	33 (3017.)		"(I read) a fairy tale."
	sietää:siedän	32 (3299.)	siedän	"I tolerate"
	hauta:haudalle	31 (3299.)	haudalle	"(to take flowers) to the grave"
	aita:aidalla	29 (3432.)	aidalla	"on the fence"
	ruutu:ruudussa	29 (3461.)	ruudun	"in the square"
	muoti:muodissa	27 (3640)	muodissa	"in fashion"
k:-	reikä:reiän	19 (4867.)	reikä	"(I repaired) a snag (in the sweater)"
	nälkä:nälässä	26 (3832.)	nälissä	"in hunger/hungry"
	pako:paossa	24 (4081.)	-	"escapes/in exile"
	raaka:raa'at	23 (4244.)	-	"not rype (bananas)"
	sika:sian	19 (4692.)	sian	pig's meat

References

- Bybee, J.. (2000). The phonology of the lexicon: Evidence from lexical diffusion. In M. Barlow & S. Kemmer (eds.), *Usage-based models of language*. Stanford: CSLI. 65-85.
- _____. (2001). *Phonology and Language Use*. Cambridge University Press.
- _____. (2002). Word frequency and context of use in the lexical diffusion of phonetically conditioned sound change. *Language Variation and Change*, Vol. 14, 261-290.
- _____. (2005). From usage to grammar: The mind's response to repetition. *Presidential Address, Oakland*.
- CSC, The Finnish IT center for science (n.d.). Suomen sanomalehtikielen taajuussanasto laskevan taajuuden mukaan (Finnish newspaper language wordlist according to descending frequency). Retrieved February, 13, 2006, from at <http://www.csc.fi/kielipankki/aineistot/ssts/frq1/phtml>
- Fidelholz, J.. (1975). Word frequency and vowel reduction in English. *CLS 11*. 200-213.
- Hakulinen, A., Vilkuna, M., Korhonen, R., Koivisto, V., Heinonen, T.R., and Alho, I. (2004). *Iso Suomen Kielioppi*. Helsinki: Suomalaisen Kirjallisuuden Seura.
- Hooper, J.. (1976). Word frequency in lexical diffusion and the source of morphophonological change. In W. M. Christie, Jr. (Ed.), *Current progress in historical linguistics*. Amsterdam: North-Holland Publishing Company. 95-105.
- Jurafsky, D., Bell, A., Gregory, M., & Raymond, W. D. (2001). Probabilistic relations between words: Evidence from reduction in lexical production. In J. Bybee & P. Hopper (eds.), *Frequency and the emergence of linguistic structure*. Amsterdam: Benjamins. 229-254.
- Krug, M. (1998). String frequency: a cognitive motivating factor in coalescence, language processing and linguistic change. *Journal of English Linguistics*, Vol. 26, 286-320.
- Labov, W. (1994). *Principles of linguistic change: Internal factors*. Oxford:Blackwell.
- Lightbown, P. & Spada, N.. (1999). *How languages are learned*. Oxford: Oxford University Press.
- Losiewicz, B.C.. (1992). *The effect of frequency on linguistic morphology*. Ph.D. dissertation. Department of Linguistics, University of Texas, Austin.

- Mowrey, R. & Pagliuca, W.. (1995). The reductive character of articulatory evolution. *Rivista di Linguistica* 7:37-124.
- Pierrehumbert, J. B. (2000). *What people know about sounds of language*. Studies in the Linguistic Sciences, 29(2) Fall, 111-120.
- _____. (2001). Exemplar Dynamics: Word frequency lenition and contrast. In J. Bybee and P. Hopper (Eds.), *Frequency and the emergence of linguistic structure* (pp. 137-157). Amsterdam/Philadelphia: John Benjamins.
- Phillips, B. S. (1984). Word frequency and the actuation of sound change. *Language*, Vol. 60, No. 2, 320-342.
- _____. (2001). Lexical diffusion, lexical frequency, and lexical analysis. In J. Bybee & P. Hopper (eds.), *Frequency and the emergence of linguistic structure*. Amsterdam: Benjamins. 123-136.
- Schuchardt, H.. (1885). *Über die Lautgesetze:gegen die Junggrammatiker*. Berlin: Oppenheim. (Reprinted and translated in T. Vennemann & T. Wilbur. [1972]. *Schuchardt, the Neogrammarians and the Transformational Theory of Phonological Change*. Frankfurt: Athenaum).
- Seliger, H. & Shohamy, E.. (2005). *Second Language Research Methods*. Oxford: Oxford University Press.

An Optimality Theory Analysis of Diminutive Suffixation of Beijing Chinese

Jun Tian

Department of Linguistics, University of Victoria
jtian@uvic.ca

ABSTRACT

The common use of retroflex [r] at the end of words in Beijing Chinese to denote a sense of intimacy, casualness and colloquialism has been studied quite extensively using different approaches. It is possible to find this diminutive suffix with all syllable shapes in Beijing Chinese. This paper proposes an OT analysis accounting for the nasal coda changes, vowel deletion, vowel preservation, and vowel insertion in the suffixed form. This analysis avoids assuming the underlying form of the diminutive suffix, a well-debated issue among rule-based analyses. This analysis also answers the questions of why a [+high, -back] vowel is not allowed in front of [r], and why the vowel changes to [ə], not any other vowel. It is noteworthy that the analysis successfully captures the data without referring to the syllable template of Chinese, which is also a controversial topic in Chinese phonology.

Keywords: phonology; diminutive suffixation; Beijing Chinese; Optimality Theory; syllable template; underlying form

1 Introduction

This paper presents a study of diminutive suffixation in Beijing Chinese. An often-used affix in some Chinese dialects is a suffix *-r*. In Chinese it is called *er hua yin* 儿化音, meaning ‘diminutive suffix’. It gets the name because the suffix is related to a Chinese word *er* [ər] ‘son’, which has a ‘smallness’ or ‘endearing’ meaning. The suffix is used in the spoken language and denotes a sense of intimacy, casualness and colloquialism to the root word. However, there is considerable variation in Chinese dialects with respect to the diminutive suffix. For example, in Shanghai dialect, there is no such suffix at all; in many other dialects that have the diminutive suffix, the suffixed forms exhibit significantly different phonological or even lexical forms (Bao, 1996; Yuan, 1989; Zhang, 2000). This paper, however, will not compare the differences of the diminutive suffixed forms in different dialects, but will focus on the diminutive suffix in Beijing dialect since it is a typical characteristic of Beijing Chinese.

This paper will provide an Optimality Theory (OT) account for Beijing Chinese diminutive suffixation without making an assumption the syllable template and the underlying form of the diminutive suffix. The paper is organized as follows: Section One

introduces the Chinese sound inventory and different claims of Chinese syllable templates. Section Two presents data in categories. Section Three reviews literature which addressed the issue of the diminutive suffix. Section Four analyzes the data by using OT constraints and ranking. Section Five concludes the paper with the significance of the OT solution proposed in this paper.

2 Beijing Chinese sound inventory and syllable templates

Beijing Chinese is the basis of Mandarin Chinese, the national lingua franca developed on the northern dialects. Similar to Mandarin Chinese, there are only six phonemic vowels¹ and four possible diphthongs in Beijing Chinese: [ai], [əi], [au] and [əu]. The first two diphthongs end with a [+high, +front] vowel [i], while the next two diphthongs end with a [+high, -front] vowel [u].

Table 1

Beijing Chinese vowel inventory

	Front		Central	Back	
	unround	round		unround	round
High	i	y	(i)		u
Mid	(e)		(ə)	ɤ	o
Low			a		

The following is the Beijing Chinese consonant inventory.

Table 2

Beijing Chinese consonant inventory

		Labial	Dental	Retroflex	Palatal	Velar
Stop	[+asp]	p ^h	t ^h			k ^h
	[-asp]	p	t			k
Affricate	[+asp]		ts ^h	tʂ ^h	(tɕ ^h)	
	[-asp]		ts	tʂ	(tɕ)	
Fricative		f	s	ʂ	(ɕ)	x
Nasal		m	n			ŋ
Liquid			l	r		

A characteristic of Beijing Chinese is the common use of retroflex [r] at the end of words. The diminutive suffix in Mandarin adopts the diminutive suffixation system of Beijing Chinese, rather than that of other northern dialects. Although the occurrence of the suffix is related to some sociolinguistic factors, which are not discussed in this paper, it is possible to find the diminutive forms with all the syllable shapes in Beijing Chinese.

¹ There are three additional vowels, i.e., [i], [e], and [ə], appearing in restricted contexts in the surface forms. [e] appears only after a consonantal equivalent of a [+high, +front] vowel, i.e., [ʈe] “moon”; [i] only with so called “syllabic consonants”, i.e., [zi] “character”; and [ə] in diphthongs or retroflexed sounds.

In addition to [r] at coda position, Beijing Chinese, same as most Chinese dialects, also allows two nasals at coda positions, [n] and [ŋ]. Therefore, the syllable structure of Beijing Chinese is (O)V{(n), (ŋ), (r)}. I avoid using C at onset position because of a big debate on whether there is a glide after an onset consonant (for example, Bao, 1996; Lin, 2001), or there is only a secondary articulation to the onset consonant (for example, Duanmu, 1993, 2000; Yin, 1989). Since the syllable template is not the focus of this analysis, we will not consider the variation of onsets in the IPA transcriptions.

3 Data

There is variation in terms of Chinese IPA transcriptions; that is, different phonologists transcribed Chinese words into different IPA forms. The main reason is that there is disagreement regarding Chinese syllable structure. Despite that, we can roughly categorize the suffixed forms into six types. The data used in this paper are based on Duanmu (2000) and Yin (1989), and many are added to make it a complete data set.

1) The first group consists of six onset consonants that include the three dental consonants and three alveo-palatal consonants in Chinese.

(1)	<i>Root</i>	<i>Diminutive Form</i>	<i>Gloss</i>
a.	tsz / tsɿ	tsər	‘character’
b.	ts ^h z / ts ^h ɿ	ts ^h ər	‘lyrics’
c.	sʒ / sɿ	sər	‘silk’
d.	tʃr / tʃɿ	tʃər	‘twig’
e.	tʃ ^h r / tʃ ^h ɿ	tʃ ^h ər	‘tooth’
f.	ʃr / ʃɿ	ʃər	‘thing’

As is seen, the transcription of the nucleus is different in the root forms, but the diminutive forms are the same. The root forms are transcribed with a syllabic consonant [z] or [r] in the peak position of a syllable by Duanmu (2000), or with a high central vowel [ɿ] in the peak position by Yin (1989). However, there is agreed transcription of the suffixed forms. The diminutive forms end with [ər] suffixation, while either the syllabic consonant or the vowel is deleted. The variation in the root transcriptions might be due to personal difference. In this paper, I will use the second IPA form of each root form as the input in the OT analysis.

2) In a second group, the roots end with diphthongs where the second component is [+high, +front] vowels. In the diminutive forms, the [+high, +front] vowels are deleted. When the root is a monophthong, [ər] is added and the vowel becomes a glide; when there is a diphthong in the root, the vowel before [+high, +front] is preserved, and only a suffix [r] is added.

(2)	<i>Root</i>	<i>Diminutive Form</i>	<i>Gloss</i>
a.	p ^h ai	p ^h ar	‘plate’
b.	pəi	pər	‘tablet’
c.	tɕi	tɕjər / tɕ ^l ər	‘chicken’

d. ʏy ʏər ‘fish’

In (2c) diminutive form there are two different transcriptions which are from the following sources: [tɛjər] from Gick and Wilson (2003), and Lin (2001), and [tɛ^jər] from Duanmu (2000), Ma (1997) and Yin (1989). Again, the existence of two different transcriptions might be due to speaker’s variation, or might be different opinions on Chinese syllable structures. The paper will not touch on the debate of the onset of Chinese syllable template. Therefore, in the OT analysis of (2c), we will treat the two transcriptions the same.

3) Another group of words preserve the identical vowels of the root forms, and simply add an [r] at the end of the word in the diminutive forms. As we can see, this group consists of a complete vowel inventory other than [+high, -back] vowels, i.e., [i, y, ɨ], and a mid vowel [ə]. This group also includes two diphthongs which do not end with a [+high, -back] vowel. The mid vowel [ə] in Chinese is only combined with [r], and it will be discussed later.

(3)	<i>Root</i>	<i>Diminutive Form</i>	<i>Gloss</i>
a.	hu	hur	‘lake’
b.	wo	wor	‘nest’
c.	ʏe	ʏer	‘moon’
d.	kɤ	kɤr	‘song’
e.	pɑ	par	‘handle’
f.	tau	taur	‘knife’
g.	kəu	kəur	‘hook’

4) There are only three vowels that can take [n] in coda position in a root. In the diminutive forms coda [n] in the roots is deleted and [r] is added. As for the vowels, there is no change for the non [+high, -back] vowels in the diminutive forms, (4a, b) for example, but the [+high, -back] vowel in the root changes to schwa [ə] in the suffixed form, (4c) for example, which is the same as the regular vowel alternations in (2).²

(4)	<i>Root</i>	<i>Diminutive Form</i>	<i>Gloss</i>
a.	p ^h an	p ^h ar	‘dish’
b.	kən	kər	‘root’
c.	tɛin	tɛjər / tɛ ^j ər	‘today’

5) There are three vowels that can take [ŋ] in coda position in a root. This nasal coda is preserved in the diminutive form and the diminutive suffix [r] is added at the end of the word.

(5)	<i>Root</i>	<i>Diminutive Form</i>	<i>Gloss</i>
a.	kaŋ	kaŋr	‘jar’
b.	təŋ	təŋr	‘lamp’
c.	k ^h uŋ	k ^h uŋr	‘free time’

² The variation in terms of the transcription of diminutive forms of (4c) follows the same pattern as (2c). They are not differentiated in this analysis.

6) The last group only has one sound, although there is tonal variation. The root itself ends with [r], and there is no change in the suffixed form.

(6)	<i>Root</i>	<i>Diminutive Form</i>	<i>Gloss</i>
a.	ər	ər	'son'/'ear'/'two'

4 Previous Analyses

Diminutive suffix has been studied quite extensively by different approaches. Some of them focus on the description of transcriptions (e.g., Bao, 1996; Chao, 1968); some focus on rule-based analyses (e.g., Duanmu, 1990, 2000; Lin, 1989; Yin, 1989; Wang, 1993). Only a few provided OT analyses with different focuses (Feng, 2002; Ma, 1997, 1998; Zhang, 2000). This section will then review three rule-based analyses, and discuss the focuses of the other OT analyses on this issue.

4.1 Rule-based analyses

This subsection will review three analyses, from which we can generalize some problems in the rule-based analysis of the diminutive suffixation.

Lin (1989) treats the suffix as a segment [r], and [r] is added to the root form and merged into one syllable in four steps.

- (a) Replace the coda with [r] or add [r] if there is no coda in the root.
- (b) Reattach the replaced coda to the nucleus if the coda is [+back].
- (c) Delete unattached sounds.
- (d) Add [ə] between a front high vowel and [r].

In this analysis, the second vowel of a diphthong is treated as a coda, and replaced by [r] at the first step, which is not consistent with most phonological analyses that treat vowels as the peak of a syllable and only consonants as coda. Secondly, deletion of [-back] codas including [n] and [i] lacks motivation; especially, [n] has a perceptually salient feature of [+nasal]. Thirdly, it is not motivated why there is a schwa insertion between a front high vowel and the suffix, not any other kind of vowel insertion.

Duanmu (1990) emphasizes feature compatibility and argues that the suffixation is completed in three steps.

- (a) Replace the coda of the syllable with [r].
- (b) Reattach any compatible features.
- (c) Delete unattached features that do not surface.

Duanmu claims that in diphthongs [ai] and [əi], [i] has a [-retroflex] feature, while [r] has a [+retroflex] feature, so this is why the [i] in a diphthong is deleted. In [au] and [əu], [u] is [+round], but [r] is unspecified for this feature, so this explains why [u] in a diphthong is preserved. Although there is a motivation for the change of a diphthong, it is still unclear why the second segment in a diphthong should be treated as a coda in the same way as nasal codas. In addition, this analysis fails to capture why the nasal [n] is deleted, while [ŋ] is saved in the suffixed form. Another problem of this analysis is that [i] in a monophthong is simply followed by [r] even though they have incompatible features, which is the motivation used to delete an incompatible segment in a diphthong. Nothing about schwa insertion is mentioned in the analysis, but it exists in the diminutive forms.

In his latest analysis, Duanmu (2000) proposes that all standard Chinese full syllables have the structure CVX, with one onset slot and two rhyme slots. The pre-nucleus glides [j, w, y] is assigned to the onset as a secondary articulation, i.e., C^G. The second rhyme slot can be a nasal coda or a second segment of a diphthong. In terms of suffixation, [r] is specified for [+retroflex] under Coronal. When added to a root, it is incompatible with other segments which also have Coronal features, including [i, y, n]. The other vowels and [ŋ] do not have Coronal feature, so they are compatible with [r] and are preserved in the suffixed form. This analysis assumes three steps as well:

(a) When a sound is incompatible with [r], the sound is replaced. Otherwise [r] is added to the sound as a secondary articulation.

(b) Rhyme segments cannot differ in [retroflex]

(c) Mid: the default height of the nucleus is mid.

A problem in this analysis concerns the syllable template proposed. If there are two timing slots in the rhyme, as the analysis assumes, [r] suffix should take the second rhyme slot rather than becoming a secondary articulation of the monophthonic vowel. Besides, in the analysis, rather than being replaced, the monophthonic [+high] vowels are preserved and allow [r] to take the second rhyme slot, which is contrary to what is assumed in Step One, which suggests when two segments are incompatible, the first sound should be replaced. Analysis in this way paves the way for his second step that the [+high] vowels change to [-vocalic] consonants [j] or [g]. And then this allows a mid vowel insertion as in Step Three. If the suffix does not take the second time slot in the first step, what is assumed in the second and the third steps cannot be achieved. So this analysis can not satisfactorily explain why [+high] vowel in a diphthong is deleted, but preserved in a monophthong.

To sum up the above three analyses, we can see that most rule-based analysis fail to answer the following questions:

(1) Why is [n] deleted, but [ŋ] is saved in the suffixed forms?

(2) Why is the inserted vowel always a schwa, not any other vowel?

(3) Why is monophthong [i] preserved, but [i] in a diphthong [Vi] not?

(4) Since there is not an agreed syllable template in Chinese, is there any other solution to capture the diminutive suffixation without referring the template?

4.2 Other OT analyses

There are only three researchers looking into the diminutive suffix in Chinese within the framework of OT, as far as I can find. Feng (2002) focuses on a Mandarin dialect spoken in Anxiang in Hunan Province in central China. In this dialect, the diminutive form is similar to a reduplication of a root with the second syllable ending with [r]. For example, the diminutive form of [ke] is [ke.kər] 'square'. What Feng proposes is that the diminutive form is still a suffixation, not a reduplication by introducing Anchoring constraints. She proposes that the suffix in Anxiang Chinese is the same as the suffix in other dialects, i.e., [r] suffix. However, the data and the discussion in this paper are very different from the topic of this paper – Beijing Chinese. We need to see if an OT solution can account for Beijing Chinese.

Zhang (2000) focuses on whether it is a MAX constraint or an IDENT constraint that selects the optimal candidate through discussing the nasal codas in four Mandarin dialects. The results show that although both constraints work for Beijing Chinese, only MAX constraints are attested cross-dialectally. He therefore argues that the right constraints to be used should be Max constraints with respect of the diminutive suffix in Chinese. A question

left unanswered is how OT captures the whole picture of the diminutive suffixation, such as the changes to vowels, in addition to the nasal changes.

Ma (1997, 1998) studies the diminutive suffix in Chinese, relying on the syllable template proposed by Duanmu (1990, 1993). So, some of the constraints proposed are template oriented. For example, in her analysis such constraints are used:

- Nucleus/V: A higher sonority nucleus is more harmonic than one of lower sonority when two are competing for one slot.
- Spread(labial): Labials must spread to a nearby consonant: front vowel to onset; back vowel to coda.

Such constraints work for her data with reference to Duanmu's syllable template. But since there is no agreed opinion on Chinese templates so far, it will be better if there is an OT solution which does not need to refer to any template but captures the data.

Thus, the objective of this paper is to propose an OT solution which can account for the data without referring to syllable template. The solution should be able to capture the [n] and [ŋ] variation, the schwa vowel insertion, deletion of some vowels versus preservation of the other vowels, etc.

5 OT analysis

In this section, we will first decide what the underlying form of the diminutive suffix of Beijing Chinese is, and then move to a detailed OT analysis of the diminutive forms.

5.1 *Diminutive Suffix*

There is no agreed form of the Mandarin diminutive yet. Lin (2001) describes it as a feature [retroflex], not a segment, but she did not discuss the reason. Some phonologists argue that the underlying form is /r/, (Chao, 1968; Duanmu, 1990, 2000), while others prefer /ər/ (Cheng, 1973; Yin, 1989). These phonologists adopt different derivational rules, but their explanations are not satisfactory. The former view does not capture why the inserted vowel is a schwa, not other vowels, such as data sets (1) and (2); while the latter view fails to explain why the schwa is deleted in some other cases, such as in data sets (3) to (5) (Ma, 1997, 1998). However, using the OT analysis, we can discuss the diminutive forms without running into such a problem. The choice of input in OT analysis is not so important compared to correctly choosing underlying forms in derivational analyses. In OT, constraints will conspire to select an optimal candidate, which is the attested form. Therefore, in our following OT analysis, we will not refer the diminutive suffix to either /r/ or /ər/; rather, we will simply use DIM to stand for the diminutive suffix. As we will see in the later analysis, this assumption will not cause any problem; thus, it will solve the conflict of other phonology assumptions.

5.2 *OT analysis*

In Beijing Chinese, the diminutive suffix always surfaces in the attested forms, and it always follows the root form. These two facts can be achieved by two undominated constraints, the ranking of which does not matter:

RMORPH: A morpheme must be phonologically realized in the output.
ALIGNR(AFFIX, R, The right edge of the affix has to align to the right edge of the
PRWD, R) prosodic word.

Tableau 1

The effect of constraints of RMORPH and ALIGNR

/pa-DIM/	RMorph	AlignR
pa	*!	
☞ par		
ra		*!
ər.pa		*!*

Another fact is that the suffixed form is always a monosyllabic word instead of disyllabic, which is very likely due to the fact that all Chinese words are monosyllabic. This fact can be achieved by a markedness constraint, and this constraint should be ranked really high as well. The effect of this constraint will be illustrated later.

*STRUC-σ: Do not have syllables.

In data sets (3) to (5), all the vowels which are not [+high, -back] are preserved in the diminutive forms. So we will assume that in the attested forms, the vowel keeps the same as the ones in the roots. The fact that the [+high, -back] vowels change to schwa will be left for discussion next. So, we need a faithfulness constraint. The suffixation is an output-output correspondence in that the input is the base and the suffix morpheme and the attested output is the affixed form. So the faithfulness constraint we need is a Base to Affixed form correspondence.

MAX-BA: Every element of base must have a correspondence in the affixed form.

So far, the ranking between *STRUC-σ and MAX-BA does not seem to matter.

Tableau 2

The effect of constraints of *STRUC-σ and MAX-BA

/pa-DIM/	*STRUC-σ	MAX-BA
pa.ər	**!	
☞ par	*	
pər	*	*!a

Because the MAX-BA constraint restricts that every element of the base must have a correspondence in the affixed form, any change to the vowels will violate this constraint. The realization of the diminutive suffix as either [r] or [ər] does not violate this MAX-BA constraint since this is a constraint for the base and affixed form, not a constraint for the suffix. Besides, we do not treat the suffix as an element, but a morpheme in this analysis.

Now, let's look at the case of [+high, -back] monophthong vowels. In all the diminutive forms, [+high, -back] vowels are deleted, including [i, y, ɨ], and a schwa takes the place. By measuring the speech of three native speakers of Beijing Chinese, Gick and Wilson (2003) confirmed Pulleyblank's (2003) claim that there should be a schwa between an advanced tongue root (ATR) vowel and a postvocalic position [r]. The reason is that the transition of tongue root or dorsum retraction is a schwa-like configuration (Gick & Wilson, 2003, p.17). However, this assumption fails to explain two facts in the suffixation in Beijing Chinese.

First, another ATR vowel [e], when followed by a postvocalic [r], does not take a schwa in between. On the contrary, a high central vowel that is not an ATR vowel [ɨ] is deleted and a schwa takes the place. So I assume that the transition of tongue root or dorsum retraction is not between an ATR vowel and [r], but is between a [+high, -back] vowel and a postvocalic [r]. That is to say, the height and frontness of a vowel, rather than advanced tongue root, influences the transition between a vowel and a postvocalic [r], the tongue position of which is not so much low as back vowels. This assumption may need more experimental support and will be studied in the future. This phonetic assumption can be captured by a markedness constraint:

*V_{[+high,-back]r}: No [+high, -back] vowel before [r].

There are three possible solutions to avoid a [+high, -back] vowel immediately preceding postvocalic [r]: to delete the vowel, to delete [r], or to add a vowel between the vowel and the consonant. As we have already discussed, all the attested diminutive forms in Beijing Chinese end with [r], and we have a constraint RMORPH to make sure that it will be preserved. So the first possible solution does not apply. If we deleted the vowel, we would expect to see an unattested form *[tɕr] for [tɕi] ‘chicken’ for example. Besides, this candidate also violates a constraint we discussed already: MAX-BA, which requires the vowel in the base be preserved in the output. So the second solution does not work either. When we consider the third solution, we can see in the attested forms, there is always a vowel insertion and the inserted vowel is always a schwa, a vowel unspecified for place cross-linguistically. Inserting any other full vowel is not grammatical. So, a markedness constraint is needed.

*PlaceV: A vowel should not have a place feature.

This constraint has to be ranked low because all the non [+high, -back] vowels are preserved in the affixed forms.

Tableau 3

The wrong ranking of constraints of *PLACEV and MAX-BA

/pa-DIM/	*PLACEV	MAX-BA
par	*!a	
③ pər		*

Therefore, when interacting with the previously discussed four constraints, the six constraints have to be crucially ranked. The MAX-BA constraint has to be ranked lower than the others in order to preserve only one full vowel in a diphthong ending with a [+high, +front] vowel, and the *PlaceV constraint has to be ranked the lowest in order to have schwa insertion. The crucial ranking like this will not affect a non [+high, +front] vowel. As we saw in Tableau 2, the constraints can toss out the unattested forms when they are not crucially ranked. So, the constraints should be able to toss out the unattested forms as well when crucially ranked.

For cases of [+high, -back] vowels, without such crucial ranking, the attested form for a diphthong would be tossed out. For example, the attested form of [p^hai] ‘plate’ with suffix is [p^har], which violates MAX-BA, but *[p^hair] does not violate this constraint, although it

violates another constraint $*V_{[+high,-back]}r$. In order for the attested candidate to win, the MAX-BA constraint has to be ranked low. So, the crucial ranking is as follows:

RMORPH, ALIGNR(SUFFIX, R, PRWD, R), $*V_{[+high,-back]}r$, *STRUC- σ >> MAX-BA >> *PLACEV

The following tableau illustrates the ranking of the constraints so far by using two words. One ends with a [+high, -back] vowel: [tʰei] → [tʰjər], ‘small chicken’, and the other ends with a diphthong which also has a [+high, -back] vowel: [p^hai] → [p^har], ‘plate’. For the sake of simplicity, we will not include the constraints of RMORPH and ALIGNR, and all the candidates violating the two constraints will not be included either.

Tableau 4

Change of [+high, -back] vowels in Beijing Chinese diminutive forms

/fi- DIM/	$*V_{[+high,-back]}r$	*STRUC- σ	MAX-BA	*PLACEV
fir	*!	*		*
f ⁱ .ər		**!		*
fər		*	*!	
fjər		*		
fjar		*		*!
fr		*	*!	
/p ^h ai – DIM/				
p ^h air	*!	*		**
p ^h ai.ər		**!		**
p ^h a.ər		**!	*	*
p ^h ar		*	*	*
p ^h ər		*	**!	
p ^h r		*	**!	

In the case of a diphthong, if only one vowel is deleted, there is one violation of MAX-BA constraint. If both vowels are deleted, there are two violations. That is how the unattested form $*[p^hər]$ is tossed out and the attested form [p^har] wins, although both of them are well-formed syllable types. In the case of deleting a [+high, -back] vowel and inserting a vowel to have a well-formed syllable, another full vowel can never take the place since it violates the *PLACEV constraint. However, when there is a non [+high, -back] vowel in the root, schwa can never take the place because of the higher ranking of the MAX-BA constraint over the *PLACEV constraint, which is illustrated by (3e) again.

Tableau 5

Full vowels in the root in Beijing Chinese diminutive forms

/pa- DIM/	MAX-BA	*PLACEV
par		*
pər	*!	

Next, we will deal with the nasal coda problems in Beijing Chinese diminutive forms. As we have seen in Section Two, all the [n] codas are deleted in the diminutive forms in data set (4), while all the [ŋ] codas are preserved at coda position in data set (5). According to

Duanmu (2000), [r] is specified for [+retroflex] which is under Coronal. Nasal [ŋ] also has a coronal feature, while [ŋ] does not. Since [ŋ] and [r] are incompatible, they are perceptually more salient. Zhang's (2000) experimental study found that the overall glottal flow is greater in the context of /C_ŋ/ than in that of /C_n/, which means that the nasality induced by the [ŋ] is perceptually more salient than the nasality induced by [n] as well. Both analyses support that we need a constraint which requires the preservation of the nasality of /ŋ/, not /n/. This constraint should be ranked really high. Therefore, we have a faithfulness constraint to preserve the [ŋ] feature of the root in the diminutive form.

MAX-IO[ŋ]: A feature [ŋ] of the input must have a correspondent in the output.

Two other related constraints are needed. In the attested forms, there are no consonant clusters in the coda position except for [ŋr], so there is a constraint to restrict the complex codas, and this constraint should be ranked relatively low, but not the lowest in order to toss out [nr], but preserve [ŋr]. There are no nasalized vowels in Beijing Chinese, so there is a markedness constraint, and this constraint should be ranked high since there is never such a case in the attested form.

*VNASAL: Vowels can not be nasals.

*COMPLEXCODA: No consonant clusters are allowed in coda position.

The crucial ranking between these constraints with the previous discussed constraints should be as follows:

RMORPH, ALIGNR(SUFFIX, R, PRWD, R), *V_[+high,-back]ɿ, *STRUC-σ, MAX-IO[ŋ], *VNASAL >> *COMPLEXCODA >> MAX-BA >> *PLACEV

For the same reason of simplicity, the RMORPH, ALIGNR, *PLACEV and *V_[+high,-back]ɿ constraints are not included in the illustrative tableau below.

Tableau 6

Nasal codas with diminutive suffix in Beijing Chinese

/pan-DIM/	*STRUC-σ	MAX-IO[ŋ]	*VNASAL	*COMPLEXCODA	MAX-BA
panr	*			*!	
pan.ər	**!				
pa.ər	**!				*
☞ pər	*				*
pãr	*		*!		
pər	*				**!
/taŋ-DIM/	*STRUC-σ	MAX-IO[ŋ]	*VNASAL	*COMPLEXCODA	MAX-BA
☞ taŋr	*			*	
taŋ.ər	**!				
ta.ər	**!	*			*
tar	*	*!			*
tãr	*		*!		
tər	*	*!			**

As illustrated in the above tableau, *COMPLEXCODA has to outrank MAX-BA in order to toss out *[panr] and allow the attested form [par] to win, in which [n] is deleted to avoid a complex coda. Because of the undominated MAX-BA[ŋ] constraint, [taŋr] wins although it violates the lower ranked *COMPLEXCODA constraint.

Some phonologists claim that there is no [taŋr], but [tãŋr], but in this paper, we argue that the vowel is nasalized for a phonetic reason because it is in a nasal environment. The nasalized vowel is universally dispreferred. A speaker can predict a vowel to be nasalized when a nasal is present. So, we will still keep the attested form as [taŋr], not *[tãŋr].

The last problem is the diminutive form of a word which is the same as the diminutive suffix. Using our current constraints and crucial ranking, we can successfully capture this data.

Tableau 7
Diminutive suffixed form in Beijing Chinese

/ər-DIM/	*STRUC-σ	RMORPH	ALIGNR	*COMPLEXCODA	MAX-BA
[ərr]	*			*!	
[rər]	*		*!		
[ər.ər]	**!				
[ər] ₁	*	*!			
☞ [ər] _{1,2}	*				

Both candidates [ər]_{1,2} and [ər]₁ are the same phonetically as the attested form. Our analysis selects [ər]_{1,2} as the optimal candidate because both morphemes are realized in [ər]_{1,2} and they are overlapped.

6 Conclusion

This paper has proposed a set of constraints and a crucial ranking to analyze the data and data sets in Beijing Chinese. It is noteworthy that the analysis avoids the conflict as for what is the underlying form of the diminutive suffix, a point not agreed upon by some phonologists. It also successfully captures the data without referring to the syllable template of Chinese, a controversial topic in Chinese phonology as well. The constraints we used in this analysis are summarized as follows:

Markedness Constraints:

- *VNASAL: Vowels can not be nasals.
- *COMPLEXCODA: No consonant clusters are allowed in coda position.
- *V_{[+high,-back]ɿ}: No [+high, -back] vowel before [r].
- *STRUC-σ: Do not have syllables.
- ALIGNR(AFFIX, R, PRWD, R): The right edge of the affix has to align to the right edge of the prosodic word.
- *PlaceV: A vowel should not have a place feature.

Faithfulness Constraints

- RMORPH: A morpheme must be phonologically realized in the output.
- MAX-IO[ŋ]: A feature [ŋ] of the input must have a correspondent in the affixed form.

MAX-BA: Every element of the base must have a correspondence in the affixed form.

As is seen, this set of conspiring constraints select the ‘optimal’ candidate and the analysis captures the change of the diminutive forms in Beijing dialect without referring the syllable template, on which there is still a debate. The arguments between different phonologists are not conflicts any more by using the above analysis. The markedness constraints used in this analysis are all cross-linguistic dispreferences, which also supports the universality of OT.

The argument of what is the underlying form of the diminutive suffix is not a necessary discussion in the OT analysis. As we can see, this analysis did not assume the underlying form as either /ɾ/ or /əɾ/, and it successfully selects the attested forms. Besides, this analysis also answers questions as when a [+high, -back] vowel is disallowed in front of [r], and why the vowel changes to [ə], not any other vowel. The change to schwa is also a universal preference of an unmarked form – the emergence of the unmarked (TETU) (McCarthy & Prince, 1994; cited in Kager, 1999, p. 198). In general, the OT analysis provides a satisfactory solution to the diminutive suffixation of Beijing Chinese.

Comparing with the other OT analyses mentioned in Section 1.3, this analysis does not refer to the syllable template; which is different from Ma’s (1997, 1998) analyses. It is thus more convincing, especially because there is not an agreed syllable template in Chinese yet. This OT analysis also captures the changes of nasal codas, vowel deletion, vowel preservation, and vowel insertion, unlike Zhang’s (2000) study, which only focuses on the nasal codas, although his study focuses on a cross-linguistic fact, rather than a particular language. In this sense, this OT solution is more comprehensive.

References

- Bao, Zhiming. 1996. The syllable in Chinese. *Journal of Chinese Linguistics*, 24: 312-354.
- Chao, Yuanren. 1968. *A Grammar of Spoken Chinese*. Berkeley: University of California Press.
- Chen, Chin-chuan. 1973. *A Synchronic Phonology of Mandarin Chinese*. The Hague: Mouton.
- Gick, B. & Wilson, I. 2003. Excrescent schwa and vowel laxing: Cross-linguistic responses to conflicting articulatory targets. *Papers in Laboratory Phonology VIII*. http://www.linguistics.ubc.ca/isrl/Gick&Wilson_LP8_RVSD.pdf Retrieved February 12th, 2005.
- Duanmu, San. 1990. *A Formal Study of Syllable, Tone, Stress, and Domain in Chinese Languages*. Ph.D. Dissertation. MIT.
- Duanmu, San. 1993. Rime length, stress, and association domains. *Journal of East Asian Linguistics*, 2.1: 1-44.
- Duanmu, San. 2000. *The Phonology of Standard Chinese*. Oxford: Oxford University Press.
- Feng, Guanjun Bella. 2002. Existential and Universal Anchoring: A Case Study of Chinese Diminutive Affixation. *2002 Texas Linguistics Society online proceedings*. http://uts.cc.utexas.edu/~tls/2002tls/TLS_2002_Proceedings.html. Retrieved on March 20th, 2005.
- Kager, R. 1999. *Optimality Theory*. Cambridge: Cambridge University Press.

- Lin, Hua. 2001. *A Grammar of Mandarin Chinese*. Lincom Europa.
- Lin, Yinhui. 1989. *Autosegmental Treatment of Segmental Processes in Chinese Phonology*. Ph.D. Dissertation. University of Texas.
- Ma, Lili. 1997. Mandarin diminutive formation: An optimality analysis. *WPLC at the University of Victoria*, 14, p. 47-59.
- Ma, Lili. 1998. Issues in Mandarin Er-Suffixation and the implications for an Optimality Analysis. *Proceedings of the Ninth North American Conference on Chinese Linguistics*, Vol. 2, p. 190-207.
- McCarthy, J. & Prince, A. 1994. The emergence of the unmarked: optimality in prosodic morphology. In M. Gonzales (Ed.), *Proceedings of the North East Linguistic Society*, 24, p. 333-379.
- Pulleyblank, E. 2003. *Pharyngeal Glide*. Manuscript. University of British Columbia.
- Yin, Yuenmei. 1989. *Phonological Aspects of Word Formation in Mandarin Chinese*. Ph.D. Dissertation. University of Texas at Austin.
- Yuan, Jiahua. 1989. *Hanyu Fangyan Gaiyao [An Introduction to Chinese Dialects]*. Beijing: Language Reform Press.
- Wang, Zhangjie. 1993. *The Geometry of Segmental Features in Beijing Mandarin*. Ph.D. Dissertation. Newark: University of Delaware.
- Zhang, Jie. 2000. Non-contrastive features and categorical patterning in Chinese diminutive suffixation: Max[F] or Ident[F]? *Phonology*, 17: 427-478.

Code-Switching in Persian/English and Korean/English Conversations: with a focus on light verb constructions

Lan Kim, Fereshteh Rezaeian

Linguistics Department, Simon Fraser University
lank@sfu.ca, rezaeian@sfu.ca

ABSTRACT

This study capitalizes on the hypothesis that typologically similar languages follow similar patterns for code-switching. Persian and Korean have similar syntactic structures. For example, both languages have the same canonical word order as Subject-Object-Verb. One of the most productive structures in both languages is light verb construction (LVC) in which an active/patient-denoting verbal element appears as the object or complement of the light verb. Our data in Persian/English and Korean/English code-switching reveal that bilingual speakers of Persian or Korean follow similar patterns when code-switching, especially in light verb constructions. In Persian and Korean bilingual light verb constructions, an L1 light verb or its inflected form is attached to an English noun, adjective, adverb, preposition, or verb.

The code switching data used in this study were collected from separate spontaneous conversations involving five Iranian-Canadian and five Korean-Canadian undergraduate students living in Canada. A one-hour conversation for each group was recorded and was transcribed by a native Persian and a native Korean speaker for further analyses.

We examine the pattern of code-switching in light verb constructions within the context of other relevant constraints that apply in code-switching situations between each language (Persian and Korean) and English. Within the range of our data, these constraints are as follows:

- Code switching does not happen for finite verbs as a single element.
- Code switching between a verb stem and its inflection is not observed.
- Code switching between a NEG and the verb is not evidenced.
- Code switching of functional words is not a normal process.

Based on our observation, we suggest that the above-mentioned restrictions are expected and are the result of the typological differences between Persian and Korean on the one hand and English on the other. This idea is in line with recent works on code switching (Mcswann, 1999) which state that any correct approach to code switching should look to code switching constraints within the relevant mixed grammars. We will also examine the structure of LVC in regard to the structure proposed by Folli et.al. (2005).

1 Introduction

Code switching can be defined as a bilingual speech act where two or more linguistic codes are used in a single conversation. Grosjean (1982) defines code switching as “the alternate use of two or more languages in the same utterance or conversation”. Scholars from different disciplines have studied code switching from different approaches and perspectives. These approaches are mainly either sociolinguistic or linguistic. Sociolinguists are mainly interested in the social and meaningful intentions associated with code switching while

linguists usually focus on the grammatical and structural rules that govern bilingual speech production. Within the linguistic framework, there have been a large number of studies that focus on discovering structural constraints governing code switching. Since 1970s, a large number of models of code switching are proposed, each of which states a particular constraint to account for this phenomenon. However, there has been disagreement on the nature of these constraints. Another new insight proposes that there is no special constraint to govern code switching and that the same principles that are operative in monolingual speech act are active in bilingual contexts (Mahootian 1993).

This paper offers a study of grammatical aspects of code switching observed in Persian/English and Korean/English bilingual speech. Persian and Korean are typologically similar languages. For example, word order of both languages is the same. Also these languages are head-final or predicate-final in that the predicate expression always comes at the end of a clause, whether the clause is a main (matrix) or subordinate one. Also, these languages show the properties of scrambling, i.e. there is one dominant word order in each language but it is optional to move elements in a sentence. Moreover, a verb's arguments and adverbial modifiers may be ordered relatively freely in these languages. Finally, there is no gender, no noun inflection, and no adjectival agreement in Persian or Korean.

This study suggests that since Persian and Korean are typologically similar languages, native speakers of these languages follow the same patterns when they switch to English. While the main goal is to compare the patterns of code switching in Persian with those in Korean, a selection of the models that have been most influential and debatable are used to see if there is a single model that adequately accounts for code switching patterns. As the result of this evaluation suggests, some models explain some cases of code switching but do not hold true in other cases.

Methodology contains the methods used in collecting data and selecting the participants. The first part of the analysis briefly describes the similarities between Persian and Korean while the focus of the second part is to represent the similarities of code switching patterns in Persian/English and Korean/English conversations. The third section of the analysis provides an evaluation of a selection of code switching models with regard to our data. Conclusion contains the main points of the study as well as some suggestions for further research. At the end, appendices A and B provide the reader with those sentences in which code switching has been observed. Appendix C contains the abbreviations used in transcription of the data and illustrates what they stand for.

2 Methodology

2.1 Participants

The code-switching experiment was conducted with 10 subjects – five native speakers of Korean and five native speakers of Persian –divided into two groups depending on their native languages. The participants were selected from among undergraduate students who have been living in Canada for more than 4 years. All participants have a common English background; they have taken English courses for at least 6 years in Canada. As for their language proficiency, all subjects should be considered to be fluent in English and to have

no problem in their communications with English native speakers. As well, all the participants must have intensive every day exposure to English.

The 10 subjects were told the purpose of the experiment at the beginning of the experiment; the examination of the alternation of English and Korean/Persian in their communication.

2.2 Procedure

At the beginning of the experiment, the subjects should fill out a questionnaire. The consent form ensured the subjects' agreement to use the recorded data for further analysis and the questionnaire is related to the students' identity and education.

The subjects were asked to participate in a one-hour group discussion. The discussion was held in a friendly atmosphere in order to have a more natural talk. To control the topic, the participants were asked to talk about their educational experiences in Canada. The topic was related to the students' every day life and encouraged them to get involved in a more active talk. It was assumed that the topic provides more opportunities for frequent code-switching than other topics do in that participants as a student are expected to be familiar with a wide range of academic-related English words or expressions.

The talk by subjects was recorded on a portable traditional tape recorder. The microphone was placed at the corner of the table around subjects, which allows receiving high-quality sound signals.

For this study, we did not consider the first five-minute sentences since the conversation was done as an opening warm-up. There were a couple of problems. Unlike expectation, there were some unclear sentences which are hard to hear and transcribe. These blurred utterances were disregarded in this research. Also, for the analysis on the proper noun such as the name of country, place, and person, they were not included as a part of code switching.

3 Analysis

This section contains three subsections. First, the similarities of Persian and Korean are represented in order to prove the claim that these languages are typologically the same. Second, the code switching patterns in Persian/English and Korean/English conversations are compared in order to find out the similarities and differences of these patterns. Finally, a selection of code switching models are used to evaluate some of the most controversial models and also to see if there is a model of code switching that can account for the entire data collected in this study.

3.1 Persian and Korean as typologically similar languages

Persian and Korean have some syntactic characteristics in common. For example, in both languages, the canonical word order is SOV. These languages are head-final or predicate-final in that the predicate expression always comes at the end of a clause, whether the clause is a main (matrix) or subordinate one, shown as in (1).

- (1) a. man sag ra did-am [Pr]
I dog OBJ saw-1SG

- b. na-nun kay-lul po-ass-ta. [Kr]
 I-TOP dog-ACC see-PST-DEC
 'I saw a dog.'

Both languages also show the properties of scrambling, i.e., there is one dominant word order in each language but it is optional to move elements in a sentence. A verb's arguments and adverbial modifiers may be ordered relatively freely. Examples (2) and (3) are selected from Persian and Korean data respectively.

- (2) a. man be Mary ketab ra dad-am. [S-I.O.-D.O.-V]
 I to Mary book OBJ gave-1SG
 b. man ketab ra be Mary dad-am. [S-D.O.-I.O.-V]
 I book OBJ to Mary gave-1SG
- (3) a. na-nun Mary-eykey chayk-ul cwu-ess-ta. [S-I.O.-D.O.-V]
 I-TOP Mary-DAT book-ACC give-PST-DEC
 b. na-nun chayk-ul Mary-eykey cwu-ess-ta. [S-D.O.-I.O.-V]
 I-TOP book-ACC Mary-DAT give-PST-DEC

However, there is a restriction on scrambling in that it does not allow the movement of the verb from the final position unless there is a strong emphasis on the verb. Example (4) clarifies the point.

- (4) a. ***dad-am** man ketab ra be Mary. [Pr]
 gave-1SG I book OBJ to Mary
 b. ***cwu-ess-ta** na-nun chayk-ul Mary-eykey. [Kr]
 give-PST-DEC I-TOP book-ACC Mary-DAT

Both languages have double nominative constructions, as is shown in (5):

- (5) a. Mary cheshm-a-sh ghashang-e. [Pr]
 Mary eye-PL-3SG pretty-is
 b. Mary-ka nwun-i yeypu-ta. [Kr]
 Mary-NOM eye-NOM pretty-DEC
 'Mary, her eyes are pretty.'

There is no gender, no noun inflection, and no adjectival agreement in both languages. Based on the above commonalities between Korean and Persian, we propose that these languages are typologically similar and contain more or less similar patterns for code-switching.

3.2 Persian/English and Korean/English code switching

The data collected in this study reveal that there are several types of code switching in Persian/English and Korean/English bilingual speech, although they occur with different

frequencies. The insertion may occur at word, phrase, or clause level and may also occur in different grammatical positions. However, there are some restrictions in code switching, i.e., certain mixes do not show up at all. Some of these restrictions are provided at the end of this section.

In both Persian and Korean, there are some similarities when code switching to English. The following examples are extracted from the data to show these similarities between the two languages.

3.2.1 Clausal level

Example (6) show that code switching may occur at clausal level.

- (6) a. *it's a big mistake* ke az Vancouver adam move-kon-e. [Pr]
 it's a big mistake that from Vancouver person move-do-3SG
 'It's a big mistake to move from Vancouver.'
- b. *that's amazing* tip manhi pat-nun-ket [Kr]
 that's amazing tip many get-AJ-thing
 'That's amazing, to get a lot of tips.'

3.2.2 Phrasal level

Code switching is also observed at phrasal levels, as is shown in (7):

- (7) a. *equal to that damage* be shoma pool mi-d-an. [Pr]
 equal to that damage to you money PROG-give-3PL
 'Equal to that damage, they give you money.'
- b. *eating together* nemwu choa [Kr]
 eating together very like
 'I like eating together.'

3.2.3 Word level

Code switching may occur at word level. In our data, we observed that subjects and objects may be switched to English. Nouns, adjectives, and adverbs are also subject to code switching but for functional words such as prepositions code switching is not a normal process.

a. Code switching in subject position

Code switching is observed for words in subject position, as is shown in example (8).

- (8) a. *manager*-a ye course-a-yi dar-an ... [Pr]
 manager-PL one course-PL-Indef has-3PL ...
 'The managers have some courses ...'
 b. *final*-i elye-wess-e. [Kr]
 final-NOM difficult-PST-DEC
 'The final exam was so difficult.'

b. Code switching in object position

Both sets of data provided in appendices A and B show that Persian and Korean speakers may choose to switch to English for words which are the object of a sentence, as is shown in (9):

- (9) a. *subject* mi-d-in raje-be-sh harf-bezan-im? [Pr]
 subject PROG-give-2PL about-to-3SG speech-hit-3PL
 'Do you give us a subject to talk about?'
 b. na-to *tutoring*-ul ha-nun-tey cwungtong-ai y-ess-e. [Kr]
 I-too tutoring-ACC do-AJ-but eastern.country-child be-PST-DEC
 'I also had a tutoring to an Eastern Asian child'

The switchability of a Persian (or Korean) verb and its English object NP shows that OV vs. VO configuration of the language pair does not have any influence on mixing. In other words identical word order is not a prerequisite for code switching. More evidence is provided in the following sections. In the following section, code switching in different categories is studied.

c. Code switching in nouns

Usually, nouns are free to be switched to English, as is shown in example (10):

- (10) a. dasht *pharmacy* mi-khoond. [Pr]
 (was+ing) pharmacy PROG-read
 'She was studying pharmacy.'
 b. *fruit-man* mek-ess-e. [Kr]
 fruit-only eat-PST-DEC
 'I had only fruit'

d. Code switching in adjectives

Code switching occurs for adjectives but it is restricted in some cases. For example, mixing of Persian and English does not freely occur whenever an EZAFE¹ exists between a noun and its modifying adjective. This could be due to the difference of noun/adjective structure of the two languages. Example (11) clarifies the point.

- (11) a. bazi-ya kheili *jealous*-an. [Pr]
 some-PL very jealous-3PL

¹ EZAFE in Persian is a link between a noun and its modifying element.

‘Some (people) are very jealous.’

- b. Harry Porter-to nemwu *funny*-ha-y. [Kr]
 Harry Porter-too very funny-do-DEC
 ‘Harry Porter was also so funny.’

e. Code switching in adverbs

In both Persian and Korean, code switching of adverbs is a normal phenomenon. Example (12) illustrates the point:

- (12) a. adam-a-ye rich *necessarily* adam-a-ye khoobi ni-st-an. [Pr]
 people-PL-EZ rich necessarily people-PL-EZ good NEG-is-3PL
 ‘The rich are not necessarily good people.’
- b. Canada-nun mwunwha-ka nemwu *open-twey-se* kun-il-i-ta. [Kr]
 Canada-TOP culture-NOM very open-become-and big-matter-be-DEC
 ‘Canada has so open culture.’

However, for the code switching of Korean and English, Korean bilinguals preserve Korean postpositional elements such as *-se* ‘and’. Again, in the case of Korean, we see that bilinguals save any postpositional elements such as conjunction or various case including nominative or accusative as well as they attach the bound verbal morpheme *-twayta* ‘to become’ or *-hata* ‘to do’ on noun, adjective, or adverb.

f. Code switching in compound verbs.

Code-switching of compound verbs is also observed in the collected data. In Persian, compound verbs are one of the most productive structures and are composed of two parts, a noun and a verb. The verb is almost always a form of a limited number of infinitives such as *boodan* (to be), *kardan* (do), *shodan* (to become), *gashtan* (grow or develop), and *zadan* (hit), as is shown in example (13). Korean speakers also do code-switching on verbs like in the case of noun, adjective, and adverb and attach *-twayko*, a combination of *-twayta* ‘to become’ and postpositional conjunction *-ko* ‘and’, as shown in example (14-a). In the same way, in (14-b), only verb ‘divide’ shows code switching, while Korean verbal morpheme *-hay* is used.

- (13) a. to vaghan mi-kha-y *move-kon-i* be Toronto? [Pr]
 you really PROG-want-2SG move-do-2SG to Toronto
 ‘Do you really want to move to Toronto?’
- b. age man be-r-am Toronto oonja *stuck mi-sh-am*
 if I Subj-go-1SG Toronto there stuck PROG-become-1SG
 ‘If I go to Toronto, I’ll stuck there.’
- (14) a. yecatul-i sayngkak-ha-nun kes chelem *common ground establish tway-ko* [Kr]
 ilen kes-i pilyo eps-ta.
 women-NOM think-do-AJ thing like common ground establish become-and
 this thing-NOM need NEG-DEC

‘As women think, guys do not need to establish the common ground.’

- b. tip *divide*-ha-y?
 tip divide-do-DEC
 ‘Do you divide the tip?’

3.2.4 Restrictions

As was mentioned before, code switching does not occur freely and there are some cases where restrictions are observed in both languages of Persian and Korean. Such cases are as follows:

- Code switching does not happen for finite verbs as a single element.
- Code switching between a verb stem and its inflection is not observed.
- Code switching between a NEG and the verb is not evidenced.
- Code switching of functional words is not a normal process.

Based on our observation, we suggest that the above-mentioned restrictions are expected and are the result of the typological differences between Persian and Korean on the one hand and English on the other. This idea is in line with recent works on code switching (Woolford 1983; Mahootian 1993) which state that any correct approach to code switching should look to code switching constraints within the relevant mixed grammars. However, further research is needed to explain how grammatical differences between two languages lead to code switching restrictions.

To sum up, We observed that code switching is a normal process occurring at clause, phrase, and word level. The above examples show that in both Persian and Korean code switching is observed for nouns, adjectives, and adverbs. However, there are some restrictions in both languages. These restrictions are evidenced whenever there is a difference between the grammatical structures of the matrix language on the one hand, and the embedded language on the other.

3.3 An evaluation of some of the code switching models

In this part, we are going to analyze our data in terms of a few models of code switching. The selection of the models is a reflection of our own judgment about the influence of each model on the studies about code switching and we admit that it is far from being complete.

3.3.1 Poplack’s Equivalence Construction and Woolford’s Model

Poplack (1981) proposes two constraints on code switching: the Equivalence Constraint and the Free Morpheme Constraint. The Equivalence Constraint stipulates that code switching takes place whenever the surface structures of the language pair map onto each other. In other words, if the surface orders are different, switching is blocked. Woolford (1983) expresses a similar idea in the context of Chomsky’s Principles and Parameters theory. She proposes that if phrase structure rules overlap, mixing of the two languages is possible and if

phrase structure rules are different, lexical items are taken from the language for which the phrase structure is unique.

The similarity of the above-mentioned views is that in both models switching is possible if the two grammars have parallel linear orders, however, the data provided in this study poses problem for both models. Considering the position of verb and object in a sentence, neither Persian nor Korean has the same order that English does, so according to the predictions of the above models we expect that switching between a Persian or Korean verb with an English object or vice versa is not possible. However, despite the dissimilarities in the position of the verb and object, we observed code switching between these two elements in our data, as is shown in example (15):

- (15) a. bachelor of science-e-sh-o gereft-e bood. [Pr]
 bachelor of science-EZ-3SG-OBJ took-PP was
 'He had got his bachelor of science.'
- b. *course*-a-ye law-ro bayad *pass mi-kard-am*
 course-PL-EZ law-OBJ should pass PROG-did-1SG
 'I should have passed (some) courses in law.'

It should be mentioned that the structure of light verbs² in Persian is such that code switching is possible for the first element but not the second one.

Moreover, the order of a noun and its modifying adjective is not the same as English but as we see in example (16), code switching is possible at these points:

- (16) a. kheili adam-a-ye nice-i-an. [Pr]
 very people-PL-EZ nice-Indef-3PL
 'They are very nice people.'

The collected data on Korean-English code switching also illustrate the violation of the equivalence constraint proposed by Poplack (1981) and Woolford (1983), like the Persian-English case. As mentioned above, the code switching on noun, adjective, adverb, and verb, Korean-English bilinguals follow methodical process, violating the equivalence constraint, as is shown in (17) and (18).

- (17) a. *accommodation*-ha-ci kulay? [Kr]
accommodation-do-AD how about
 'How about having accommodation?'
 'accommodation' + *ha-ci*
 (English N.) + (Korea Verb *-hata*; inflected as an adverb)
- b. sensayngnim-i *selective-ha-key* tane ha-lako-ha-y-se, ta oyweya-ha-ss-e.
 instructor-NOM **selective-do-AD** word do-IMP-do-DEC-and whole
 should.memorize-do-PST-DEC

² Light verbs are one of the most productive structures in Persian. They are compound verbs consisted of a noun and a verb. The verbs are usually a form of the following infinitives: boodan (to be), shodan (to become), gashtan (grow).zadan (hit), etc.

‘We had to memorize whole the words because the instructor says selective words.’
 ‘selective’ + **ha-key**
 (English Adj.) + (Korea Verb *-hata*; inflected as an adverb)

- (18) tip *divide*-ha-y? [Kr]
 tip divide-do-DEC
 ‘Do you divide the tip?’
 ‘divide’ + **ha-y**
 (English V.) + (Korea Verb *-hata*; inflected as an informal form)

In sum, we see that Korean-English bilinguals attach Korean verb such as *-hata* ‘to do’ or *-toyta* ‘to become’ on English noun, adjective, or verb, which demonstrates that equivalence constraints do not exist in code switching. Following summarize this.

	Noun		
English Adjective		+	Korean Verb
	Verb		

As we observed in the above examples, the major problem with the models proposed by Poplack and Woolford is their empirical adequacy. Although many cases of code switching may be accountable by these models, there are some counterexamples which violate the predictions made in these models.

3.3.2 The Free-Morpheme Constraint Model

The Free Morpheme Constraint (Poplack 1981) states that code switching between a free morpheme and a bound morpheme is not possible; however, there are a lot of examples in our data which violate this rule, such as example (19):

- (19) a. pesar-a kheili **effective-tar** az dokhtar-a-n. [Pr]
 boy-PL very effective-COMP from girl-PL-3PL
 ‘The boys are much more effective than the girls.’
 b. **intense-ha-key** anh ha-y. [Kr]
 intense-do-AD NEG do-DEC
 ‘This is not an intense one.’

As the above examples illustrate, the Free Morpheme Constraint model is not capable of accounting for the code switching of free morpheme and bound morpheme of two different languages.

3.3.3 Mahootian’s Model

Mahootian (1993) proposes that code switching is not governed by any constraint outside the grammars of the code switching languages. She suggests that the same rules and

principles which operate on monolingual utterances account for code-switched utterances. She uses a tree-adjoining grammar (TAG) to explain the process of code switching. Santorini and Mahootian (1995) state that there is a principle on code switching between two languages:

The language of a head determines the syntactic properties of its complements in code-switching and monolingual contexts alike. (Santorini and Mahootian 1995)

In other words, the language of a head determines the phrase structure position, category, and feature content of its complement. One of the predictions made by this model is related to the code switching pattern of verbs and their objects. Languages may be VO or OV, i.e. verbs may take a DP object complement either to their right or to their left side. The difference between the two types is illustrated below:

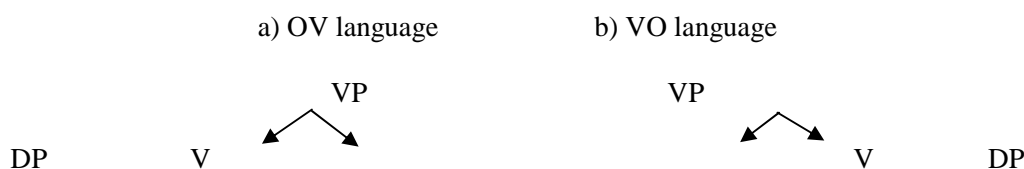

Using Persian data, she proposes that Farsi³ and English are VO and OV languages respectively. In code-switching between these two languages, there are four possible combinations of head and complements, as is shown below:

- a) O_F, V_E
- b) O_E, V_F
- c) V_E, O_F
- d) V_F, O_E

Mahootian (1995) predicts that from the above combinations, only (b) and (c) are consistent with the verb's requirement regarding the position of its complement.

This model can correctly predict the pattern of code-switching between two typologically different languages, however, Myers-Scotton (1999) argues that the principle of code switching stated in this model overpredicts. She says that if there is no ML in code switching, then the prediction is that there could be a switch in syntactic rules and functional elements with each head. According to Myers-Scotton, this is not what happens in real code switching data. Our suggestion is that although Mahootian's model is predictive in many cases, more studies are required to verify the code switching principle proposed by this model.

4 Conclusion

A number of studies on code switching have been investigated on the unified account of grammatical mechanism in code switching over languages. While we assume that these

³ Farsi and Persian are the same and both refer to the official language spoken in Iran.

studies are able to account for Persian-English and Korean-English code switching, what this current study reveals is that each model is not sufficient enough to consider the present result from Persian and Korean bilinguals' code switching. In particular, it is difficult to find any equivalence constraints and free-morpheme constraints from both Persian-English and Korean-English code switching. As mentioned, in Persian-English code switching, switching Persian verb with English object or vice versa is possible while Persian and English has underlying different linear order, as SVO versus SOV. This is also attested in code switching of a noun and its modifying adjective in spite of the different linear order of Persian and English. Like the Persian-English code switching, Korean-English code switching illustrates that a certain model of equivalence constraints and free-morpheme is not enough to explain the data in Korean-English code switching; attaching Korean verbal morpheme *-hata* 'to do' or *-toyta* 'to become' as well as its inflected form such as *-hakey* onto English words shows the inadequacy of equivalence constraints on code switching. In addition, frequent attaching of the bound morpheme such as plural or adverb onto English words in Korean displays that the model of free morpheme is not enough to account for the code switching. This is also shown in Persian-English code switching since Persian does not allow to have code switching on bound morpheme; morpheme such as plural, copula, or clitic Pronoun as possessive pronoun.

Thus, from both Persian-English and Korean-English code switching, we confirm that Joshi (1985)'s model on code switching fits well with our analysis. As he mentioned, aux., tense and helping verbs come from the matrix language and code switching is not possible at these points, although this model does not propose any prediction for other types of words.

Even if our trial on unified account of Persian and Korean from code switching seems to be alien, our analysis reveals the possibility that typologically similar languages like Persian and Korean, which both have a SOV grammatical order, can show some relevance in code switching. Further studies can explore more details that two or more languages are able to reveal similar characteristics on code switching if the languages have similar typology. Also, why bilingual speakers preserve their native language's aux., tense, or verbal (or adverbial) morpheme can be important studies for future research to illuminate code switching over languages.

Acknowledgement

We are indebted to Dr. Panayiotis Pappas who depend our knowledge and understanding on code-switching. We are also grateful to Dr. Chung-hye Han, Dr. Simin Karimi, and fellow graduate students in the department of Linguistics at SFU, and audience at the 35th New Ways of Analyzing Variation (NWAV) and 23rd NorthWest Linguistics Conference (NWLC), for their comments on this research. All errors are ours.

Bibliography

- Folli, R., Harley, H., & Karimi, S. (2005). Determinants of Event Type in Persian Complex Predicates. University of Cambridge & University of Arizona. *Lingua* 115:1365-1401.
Greenberg, Joseph H. (1963). *Universals of Language*. London: MIT Press. 73 – 113.

- Grosjean, F. (1982). *Life with Two Languages. An Introduction to Bilingualism*. Cambridge, MA: Harvard University Press.
- Joshi, A. (1985). Processing Sentences with Intra-sentential Code Switching. In Dowty, D.R. Karttunen, L. & Zwicky, A. *Natural Language Parsing*. 190 – 205. New York: Academic Press.
- Karimi, S. (1999). Is Scrambling as Strange as We Think It Is? MIT Linguistics Working Papers (MITLWP). Department of Linguistics, MIT.159-190.
- Mahootian, S. (1993). *A Null Theory of Code-switching*. Doctoral Dissertation. Northwestern University
- Mahootian, S. (1996). Code Switching and Universal Constraints: Evidence from Farsi / English. *World Englishes*. V: 15(3). 377 – 384.
- Mcswann J. (1999). *A Minimalist Approach to Intrasentential Code Switching*, Garland Publishing, New York & London
- Myers-Scotton, C. (1999). Morpheme Organization in the Mental Lexicon: Evidence from Language Contact Phenomena. Paper for the Second International Symposium on Bilingualism. 14 – 17. Newcastle, England.
- Poplack, S. (1981). The Notion of the Plural in Puerto Rican Spanish: Competing Constraints on (s) Deletion. *Locating Language in Time and Space*, ed. by William Labov, 55-67. New York: Academic Press.
- Santorini, B., & Mahootian, S. (1995). Code-switching and the Syntactic Status of Adnominal Adjectives. *Lingua*, V/Issue: 96(1). 1 – 27.
- Toribio, A. J. (2001). On the Emergence of Bilingual Code Switching Competence. *Bilingualism: Language and Cognition*, Vol. /Issue: 4(3). 203 – 231.
- Winford, D. (2005). *An Introduction to Contact Linguistics*. Blackwell Publishing. 101 – 165.
- Woolford, E. (1983). Bilingual Code Switching and Syntactic Theory. *Linguistic Inquiry*. V: 14. 520 – 536.
- Yoon, K. K. (1992). New Perspective on Intrasentential Code-switching: A study of Korean-English Switching. *Applied Psycholinguistics*. V:13. 433-449.

English *tr* Produced by Mandarin Speakers

Ya Li

University of Victoria

yali@uvic.ca

ABSTRACT

This pilot study aims to investigate English *tr* produced by Mandarin speakers through an acoustic analysis. In Mandarin, the consonant cluster *tr* is not permitted. However, Mandarin has the aspirated retroflex affricate, /tʂ/ (orthographically *ch* in Mandarin), which is phonetically close to both English *tr* (/tɹ/) and *ch* (/tʃ/) in terms of the place of articulation (all produced in the post-alveolar area). According to Flege's (1995) Speech Learning Model (SLM), these similar sounds may interfere with one another in both second language perception and production. Previous studies also find that linguistic environment such as the vowel context has a significant effect on consonant or consonant cluster production (Hansen, 2001 & 2006).

Based on the above model/finding, this study aims to address the following research questions: 1) How do English *ch* or Mandarin *ch* interfere with Mandarin speakers' production of English *tr*? 2) What role does the vowel context play in the production? Eight Chinese participants were recruited to perform a reading task containing four English monosyllabic words, *true*, *chew*, *tree*, *cheer* and one Mandarin word, *chù* ('place'). Two participants' speech data were further converted into spectrograms and acoustically analyzed based on the formant patterns.

Two major findings emerged from the acoustic analysis: 1) one Mandarin speaker's production of *tr* occurs as *ch* only when the following vowel is /u/, indicating the vowel context is crucial in determining the substitution of *ch* for *tr*; 2) the other Mandarin speaker's production of *tree* is similar to /tʂqi/, where *q* is a high front rounded glide in Mandarin. Since /q/ shares the lip-rounding feature with /ɹ/, /tʂqi/ and /tɹi/ are similar in terms of both the place and the manner of articulation. Also, the production of /tɹi/ as /tʂqi/ turns the English syllable structure CCV into the permissible Mandarin syllable structure CGV. Overall, the findings not only confirm the model/finding mentioned earlier, but also show that substitution between similar sounds can take place at the syllabic level as well as the segmental level.

Keywords: Consonant cluster *tr*; acoustic analysis; substitution at the syllabic level; vowel context.

1 Introduction

The researcher observed that Chinese speakers often produced English *tr* differently from native speakers; for example, *true* is produced like *chu*, similar to a Mandarin syllable, *chù*. The present study will investigate Mandarin speakers' production of the English consonant cluster *tr* through an acoustic analysis. The organization of this paper is as follows: Section 2 will review previous studies in second language (L2) consonant cluster production and provide the theoretical framework for the present study; Section 3 will explain the research methodology and Section 4 will provide the acoustic analysis of speech data and present important findings; Section 5 will discuss the theoretical and pedagogical implications of the findings for second language production; Section 6 will summarize the study and propose directions for future research.

2 Previous studies

2.1 L2 consonant cluster production

Research on L2 consonant cluster production has been conducted from different perspectives. Earlier researchers focused on how differences between the first language (L1) and L2 sound structure may interfere with L2 acquisition (James, 1980). For example, Cantonese speakers tend to simplify English consonant clusters by deleting a consonant, since most Chinese dialects such as Mandarin and Cantonese do not permit consonant clusters (Tarone, 1987).

Later studies also find the effect of linguistic environment on L2 consonant cluster production. For example, Anderson's (1987) study reveals that Mandarin speakers delete *r* mostly in final clusters and word-medial sequence (in Hansen, 2001). Hansen's (2001) study also shows homo-voicing coda clusters favor absence in Mandarin speakers' production. In addition, Benson's (1988) study finds that Vietnamese speakers tend to delete a final consonant when it follows a diphthong vowel (mentioned in Hansen, 2006).

These studies tend to identify the reduction of consonant clusters as the major type of error in L2 production. However, I observed that Chinese speakers often substituted *tr* with the similar sounding affricate *ch* instead of deleting *r* in *tr*. In fact, Flege's (1995) Speech Learning Model (SLM) claims that similarities rather than differences between L1 and L2 segments are the major source of difficulty for L2 speech learners (in Tarone, 2005).

Based on the above model/findings, the present study aims not only to provide acoustic evidence for Flege's (1995) segment-based SLM, but also to show that the production of the consonant cluster *tr* can be largely influenced by the following vowel.

2.2 Research questions

Two research questions are to be addressed in this study: 1) How do English *ch* or Mandarin *ch* interfere with Mandarin speakers' production of English *tr*? 2) What role does the vowel context play in the production?

3 Research methodology

3.1 Participants

Eight Mandarin Chinese speakers (7 males and 1 female), aged between 18-26, all Chinese international students at University of Victoria (UVic), participated in my study. Also, a native English male speaker's production were recorded and used to illustrate a standard way to produce *tr* and *ch*.

3.2 Instruments

3.2.1. Word-list reading task

The word-list contains 4 English and 1 Mandarin monosyllabic words starting with *tr* or *ch* and ending with the high back vowel /u/ or the high front vowel /i/, as shown in Table 1 (see also Appendix A):

Table 1

The test words used in the word-list reading task

C (C) V	/u/	/i/
/tɹ/ <i>tr</i>	true	tree
/tʃ/ <i>ch</i>	chew	cheer
/tʂ/ <i>ch</i>	chù ¹	n/a ²

In Table 1, *ch* is used to contrast with *tr*; the two vowels, /u, i/, are used to investigate the effect of linguistic environment on the production of *tr*. A Mandarin word, *chù* (with the fourth tone on *u*) is also included for the Chinese participants to produce. In total, 15 (5 words x 3 tokens) tokens are included.

The Mandarin retroflex affricate /tʂ/ (orthographically *ch* in Mandarin) is phonetically close to both English *tr* and English *ch* in terms of the place of articulation, as they are all produced in the post-alveolar area. According to Flege's (1995) SLM, these similar sounds may interfere with one another in the English production of the Mandarin speakers.

¹ To avoid orthographical interference, the Chinese word is written in Chinese in the actual reading task sheet.

² Mandarin does not have *chi*.

3.2.2. Questionnaire

The questionnaire (see Appendix B) is administered to elicit relevant personal data of Chinese participants, such as gender, major, school year, and the length of the English education (see Appendix C for a summary of the data). The information is used to examine possible correlations between the speakers' background and their production.

3.3 Procedures

- 1) Eight Mandarin participants were recorded by using Olympus Digital voice recorder (WS-100) in a quiet room.
- 2) After the 8 participants' production was carefully listened to by the researcher, 2 male participants with clear articulation and typical pronunciation were chosen from the 8 participants and further recorded in the phonetic laboratory at UVic, using Audacity 1.2.4. The native English male participant was also recorded in the same phonetic laboratory.
- 3) The 3 participants' speech data were analyzed, using Praat 4.4.22. Specifically, the waveform and spectrogram of each token produced by each participant were examined. Then a relatively typical spectrogram was chosen from 3 tokens to represent each word. In total, 14 spectrograms (5 words x 2 Chinese participants + 4 words x 1 English participant) were collected and compared/contrasted. Eleven of them will be illustrated in the following acoustic analysis (the other three spectrograms can not be used here due to fuzziness).

4 The acoustic analysis of the speech data and findings

4.1 Basic acoustic properties of *tr* and *ch*

The analysis is based on the articulatory mechanisms of English *tr*, *ch* and Mandarin *ch*. Generally, *tr* is considered to be a co-articulated consonant cluster in English, while both English *ch* and Mandarin *ch* are affricates. *tr* is a combination of the voiceless stop /t/ and the rhotic approximant /r/; English *ch*, on the other hand, is a combination of the voiceless stop /t/ and a voiceless fricative /ʃ/. Similarly, Mandarin *ch* is a combination of the voiceless stop /t/ and a voiceless fricative /ʃ/. In fact, Ladefoged and Maddieson (1996) classify Mandarin /ʃ/ as the flat post-alveolar fricative rather than a retroflex. In contrast, English /ʃ/ is classified as the domed post-alveolar fricative. Therefore, English *ch* and Mandarin *ch* are very similar in terms of not only the manner of articulation but also the place of articulation, because they both can be considered as post-alveolar affricates.

Figure 1, the spectrograms of *true* and *chew*, and Figure 2, the spectrograms of *tree* and *cheer* are extracted from the native English speaker's production. The difference between productions of *tr* and *ch* can be observed clearly in the four spectrograms. The first segment /t/ in *tr* and *ch* is represented by a blank area followed by a vertical line (see the spectrograms of *chew* and *cheer*). The blank area indicates the silent period when articulators (the tongue

tip and the alveolar) are closed; the vertical line indicates the release burst of the closed articulators (Hayward, 2000). The second element /ɪ/ in *tr* comprises two parts: the voiceless and the voiced; that is, /ɪ/ in *tr* is partially devoiced to assimilate the preceding voiceless stop /t/. Notice the two parts together form a V-shaped pattern (see the spectrogram of *true*). The voiceless part of /ɪ/ (phonetic representation, [ɪ̥]) can be observed as vertical striations immediately following the vertical line, indicating noisy airflow that accompanies voicelessness. The voiced part of /ɪ/ includes a rising F3 (the third formant), indicating the F3 of /ɪ/ is lower than the following vowel (see the spectrogram of *true*). Note in the spectrogram of *true*, the lower part of F3 is conflated with F2.

Unlike /ɪ/, the second element /ʃ/ in English *ch* only has striations across the upper frequency range, indicating frictions caused by airflow passing through narrowed articulators (Davenport & Hannahs, 1998). Notice the onset part of *tr* (representing /tɪ/) is similar to /tʃ/, both with a vertical line followed by massive striations (see Figure 1). Also the spectrogram of *chew* shows a palatal sound /j/ between /ʃ/ and /u/, a typical pronunciation for some English speakers.

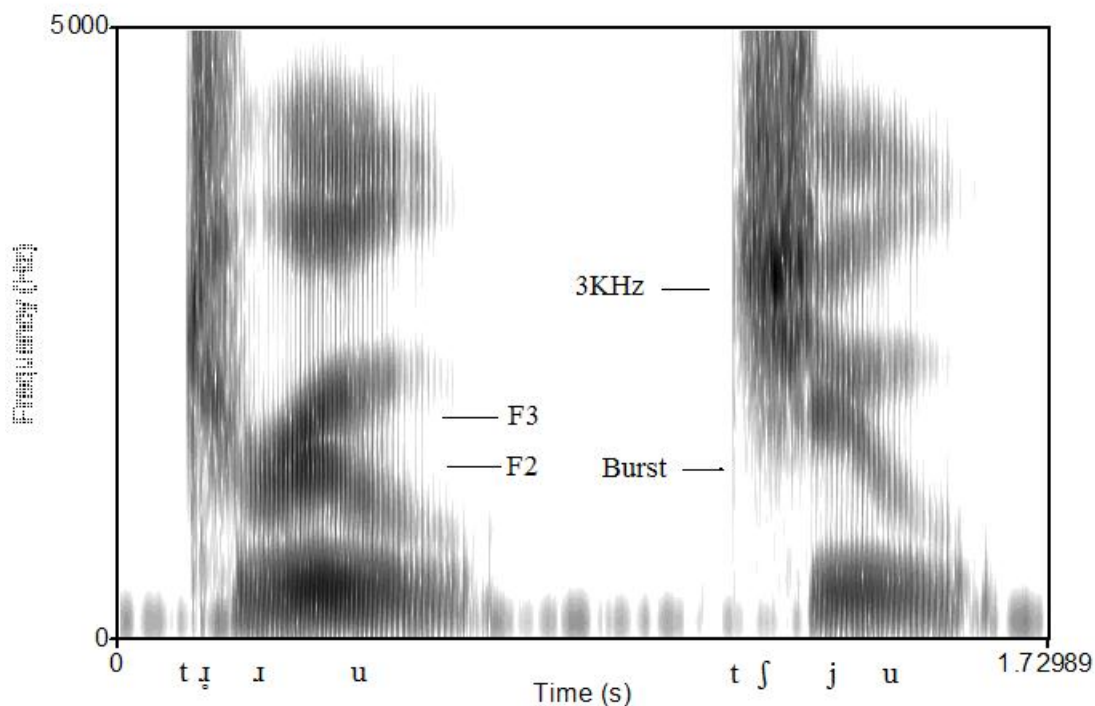

Figure 1

Spectrograms of *true* (left) and *chew* (right) produced by the native English speaker.

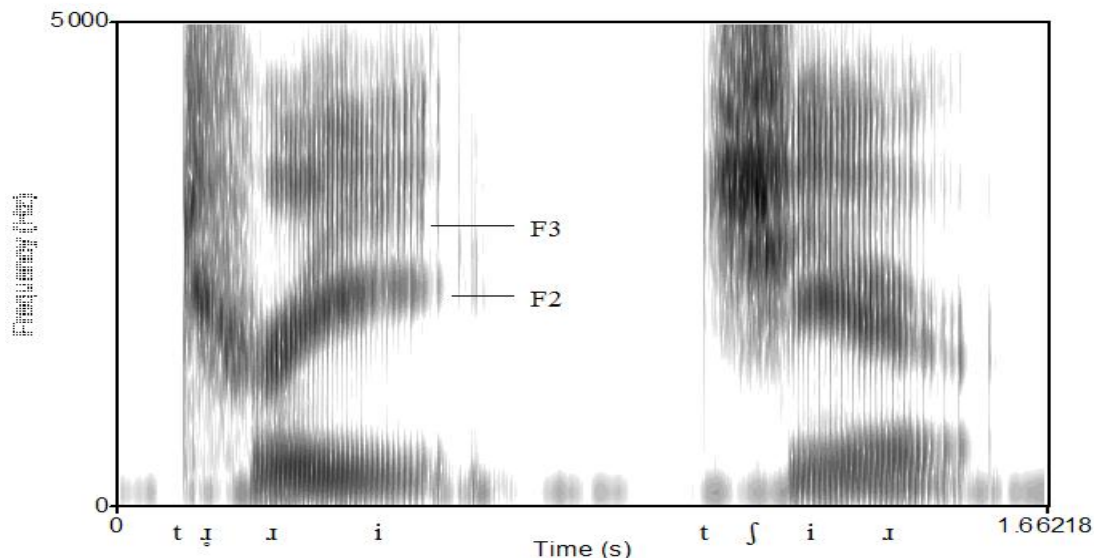

Figure 2
Spectrograms of *tree* (left) and *cheer* (right) produced by the native English speaker

Figure 3 provides the spectrograms of *true* and *chew* produced by the first Mandarin male speaker. The two spectrograms show almost identical onset patterns: a vertical line (the release burst for /t/) precedes striations. Notice the V-shaped formant pattern for /ɪ/ is missing from the spectrogram of the presumably *true* (i.e., The speaker thought he was producing *true*), indicating that this speaker produced *tr* similar to *ch* when the following vowel is /u/.

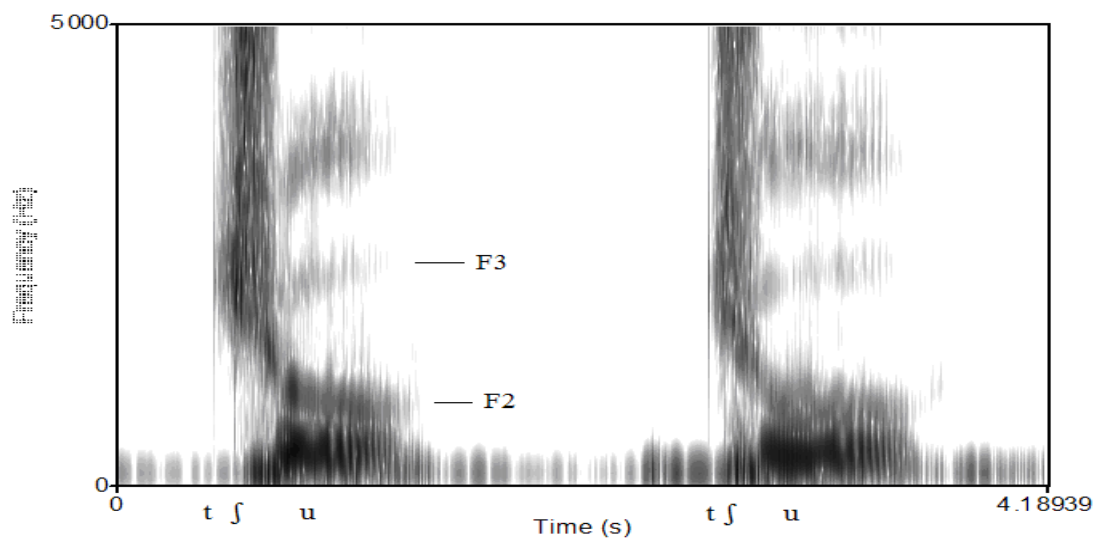

Figure 3
Spectrograms of *true* (left) and *chew* (right) produced by the first Mandarin speaker

Figure 4 shows how the same speaker produced *ch* in the Mandarin word *chù*. Similar to the spectrograms of *true* and *chew* in Figure 3, the onset part of *chù* has massive striations, and no V-shaped formant pattern is present, so it seems hard to differentiate this speaker's productions of English *tr*, *ch*, and Mandarin *ch* when the following vowel is /u/. Sometimes, based on the frequencies around the darkest striations, it is possible to infer which fricative is involved. According to Davenport & Hannahs (1998), the higher the frequencies, the further forward the place of articulation is. Thus, the post-alveolar fricative /ʃ/ has the frequencies around 3kHz, the retroflex fricative /ʂ/ around 2kHz. For example, In Figure 1, the native speaker's production of /ʃ/ has the darkest striations around 3KHz. For this Mandarin speaker, however, it is hard to identify the height of the darkest striations in the spectrograms of *true*, *chew*, and *chù* (see Figures 3 & 4). The darkest striations for *true* and *chew* start almost at the same height around 2KHz, again indicating *tr* was similarly produced as *ch*.

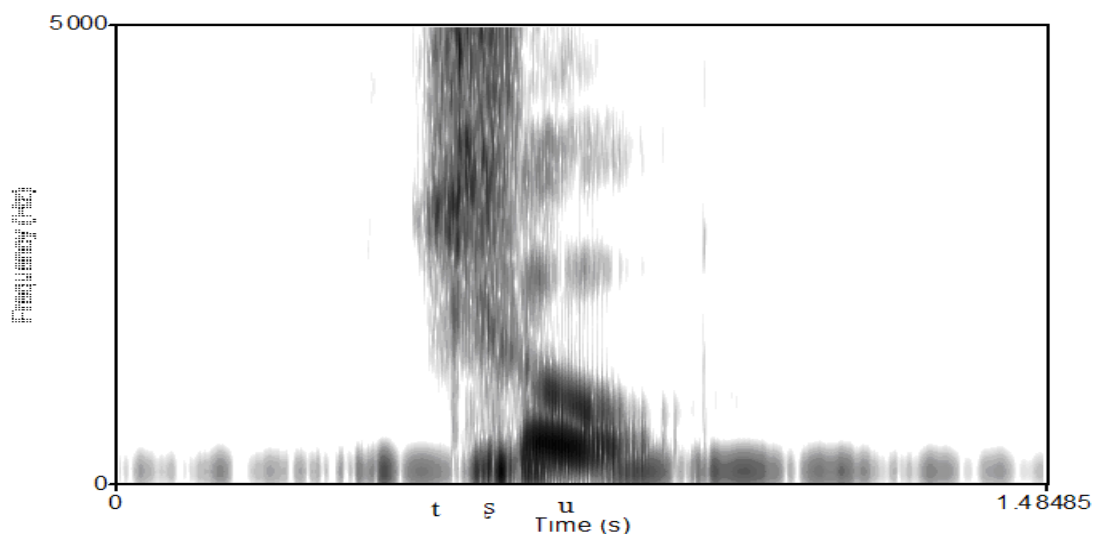

Figure 4
Spectrogram of the Mandarin word *chù* produced by the first Mandarin speaker

In Figure 5, however, there is a noticeable difference between the speaker's productions of *tree* and *cheer*. In the spectrogram of *tree*, F2 and F3 gradually move upward following the striations at the onset, which forms a rather narrow V-shape (indicating /t/). In the spectrogram of *cheer*, only the high frequency striations (indicating [ʃ]) are present, followed by the downward-going F2 and F3 signaling transitions from /i/ to the final /ɹ/ in *cheer*. The difference between the onset patterns of the two spectrograms indicates that the speaker was able to treat *tr* and *ch* differently when the following vowel is /i/.

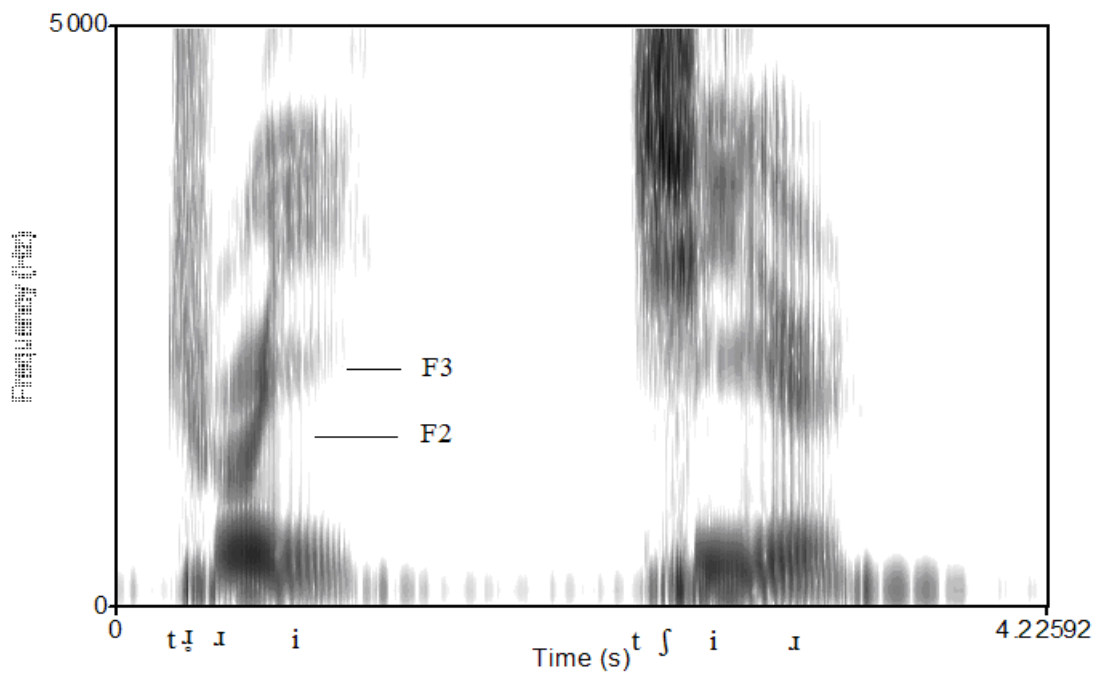

Figure 5

Spectrograms of *tree* (left) and *cheer* (right) produced by the first Mandarin speaker

Figure 6 illustrates how the second Chinese male speaker produced *tree* and *cheer*. In contrast to the first Chinese speaker, this speaker's production of *tree* is similar to /tʃqi/, with a lip-rounding glide /q/ in between the affricate /tʃ/ and the vowel /i/. In the spectrogram of the presumably *tree*, the striations are followed by gradually rising F2, F3, and F4. According to Fant (2004), lip rounding has a general effect of lowering formants, so the rising formant transitions indicate the change of place of articulation from a high front rounded position towards a high front unrounded position (i.e., from the glide /q/ to the target vowel /i/). Notice that although the production of /ɿ/ also involves lowering F2 and F3 (i.e., /ɿ/ and /q/ both share the lip-rounding feature), the formant pattern of /ɿ/ can be still distinguished from that of /q/ by the rapidly lowering F3 and the absence of the higher formants such as F4 and F5.

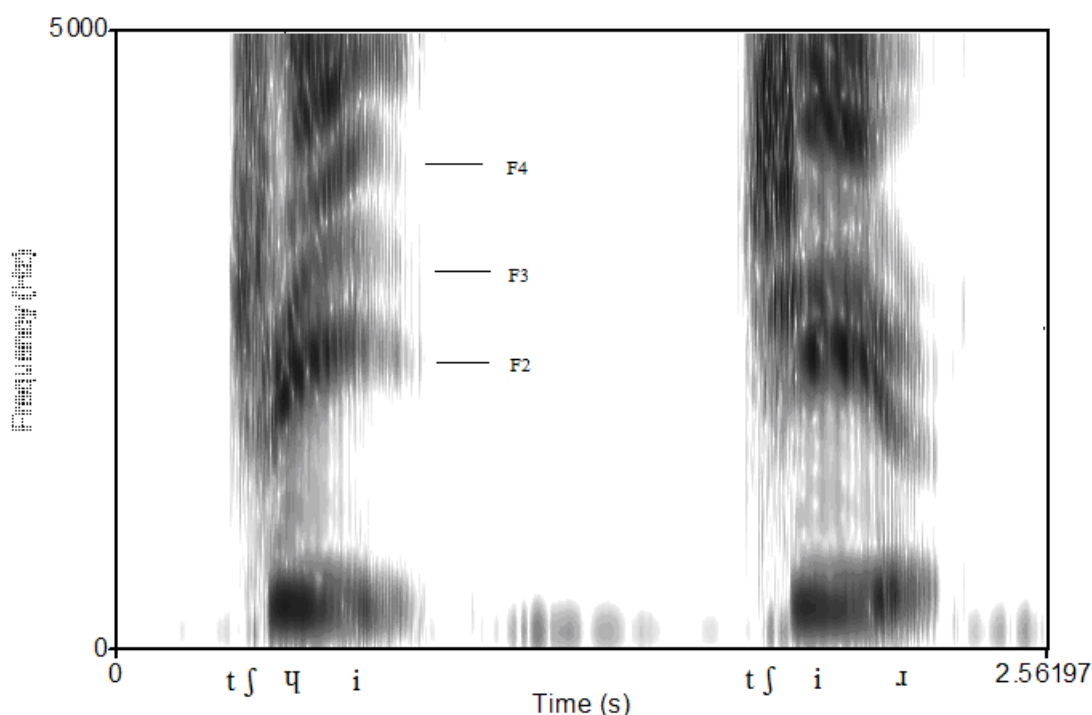

Figure 6
Spectrograms of *tree* (left) and *cheer* (right) produced by the second Mandarin speaker

Based on the results from the above analysis, the two research questions can be answered. 1) How do English *ch* or Mandarin *ch* interfere with Mandarin speakers' production of English *tr*? Figure 3 shows that the production of English *tr* by the first speaker occurs as *ch* only when the following vowel is /u/. Note that the distinction between English *ch* and Mandarin *ch* is not clear in this speaker's production. 2) What role does the vowel context play in the production? Figure 5 shows that the production of *tr* by the first speaker is more or less native-like when the following vowel is /i/, but Figure 6 shows that the production of *tr* by the second speaker is influenced by *ch* in the same vowel context. Note the influence involves substituting /tɿ/ with the syllable /tʃɿ/ rather than /tʃi/ alone.

5 Theoretical and pedagogical implications

The above results also raise the following question: why can the first Mandarin speaker produce *tr* native like in *tree* but not in *true*? An explanation could be that /tɿ/ and /tʃu/, both sharing the acoustically prominent lip rounding feature (i.e., the rounded /u/), are similar enough for substitution; while that /tʃi/, a potential candidate for substitution, does not share the lip rounding feature with /tɿ/, so they are not similar enough for substitution. As a result, the speaker may have learned to produce *tree* native-like.

However, if /ɥ/ is inserted into /tʃi/, then /tʃɥi/ and /tɥi/ both share the lip-rounding feature (/ɥ/ and /ɥ/ both involve lowered F3) and therefore become very similar. In other words, when the glide /ɥ/ is used to fill the missing lip-rounding feature in /tʃi/, the substitution of /tʃ/ for /tɥ/ becomes possible, as seen in the second speaker's production of *true*. Also, the production of /tɥi/ as /tʃɥi/ turns the English syllable structure CCV into the permissible Mandarin syllable structure CGV. In fact, after the researcher carefully listened to the other 6 Chinese participants' production, /tʃɥi/³ is found to be a preferred production instead of /tɥi/ (clearly occurred in 4 out of 8 speakers' production). Since the substitution of /tʃɥi/ for /tɥi/ takes place at both the syllabic level and the segmental level, Flege's (1995) SLM model can be expanded to include similarities between syllables, not just segments, as a source of interference.

Pedagogically, the above findings have two implications. First, the traditional minimal pair drills can include the consonant cluster perception and production. For example, the words used in the reading task such as *true* and *chew* can be used to train Chinese ESL learners to differentiate *tr* and *ch* in different vowel contexts. Second, ESL teachers are necessarily trained to know the phonological structure (including syllable structure) of their students' first language. Suppose an English teacher knows how the Mandarin *chù* is produced. He or she can include it in the minimal pair training with *true* and *chew*. This method is in fact the essence of "contrastive teaching" discussed by James (1988). The purpose of contrastive teaching is to make the students put more conscious effort in distinguishing between their native sounds and the sounds of their second language (James, 1988). For example, after the researcher explained in plain language to a participant how *true* was different from and similar to English *chew* and Mandarin *chù* in terms of the articulatory mechanism and the syllable structure, his ability to distinguish these words has improved in an informal perception test conducted by the researcher. The improved perception in turn might be able to help to improve this participant's English production.

6 Conclusions

Although the data in this pilot study are relatively scanty, the results are informative: interference between the consonant cluster *tr* and the affricate *ch* is based mainly on their similar features such as the post-alveolar articulation and the voicelessness after the release of *t*. However, the interference is caused not only by the similarities between the two sounds, but also determined by the following vowel. Depending on the vowel context, different substitutes for *tr* occurred in the two Mandarin speakers' production; that is, /tʃu/ was used to replace /tu/ and /tʃɥi/ was used to replace /tɥi/. These results provide evidence to both support and extend Flege (1995)'s SLM model, suggesting that interference based on similarities between two sounds can take place not only at the segmental level but also at the syllabic level.

³ Although /tʃɥi/ conforms to the Mandarin CGV structure, it is not a Mandarin syllable.

This study examines only eight Mandarin speakers' production of *tr*, so more participants can be included in future research. Also, more test words can be chosen to measure further influence of linguistic environment. For example, future research could compare *tree* with the Mandarin words *qi* and *qù*, where *q* (/tʃ/) is a palatal affricate similar to *ch* (/tʃ/) and *ù* in *qù* is a high front rounded vowel corresponding to the high front rounded glide /ɥ/ in Mandarin. In a word, based on the present study, future research can be conducted on a larger scale.

Acknowledgments

I would like to thank Dr. Li-Shih Huang for her helpful comments and my fellow graduate student Thomas Magnuson for providing the native production data in the study. Also, I would like to thank my supervisor Dr. Hua Lin for encouraging me to submit the abstract to the 23th NWLC conference.

Appendix A. Reading Task

1. Please read the following English words slowly.

- | | | | |
|----|-------|-------|-------|
| a. | cheer | cheer | cheer |
| b. | chew | chew | chew |
| c. | true | true | true |
| c. | tree | tree | tree |

2. Please read the following Mandarin words slowly (for Mandarin speakers).

处 处 处

(处: /chù/, 'place')

Appendix B. Questionnaire

Thank you for participating in my language survey about the English pronunciation of Chinese students. There are no right or wrong answers. The data will be used to provide background information for my study. No identification information will be asked in this survey. The consent form will be detached from both this page and from the recording.

Gender: School year: Major:

1. Do you speak a Chinese dialect other than Mandarin? If so, please specify the dialect you speak, for example, "Beijingshua" and "Cantonese."
2. At what age did you start to learn English?

3. Have you taken or are taking any ESL courses in Canada or other English speaking countries?

Appendix C. Summary of 8 Chinese participants' personal data

The total number of participants in this study	8 (1 female and 7 males)
Age range	From 18 to 26
School year range	6 from 1 st year to 4 th year, 2 in MBA 1 st year
Major (number of participants)	Economics (5), MBA (2), Electronic Engineering (1)
Chinese dialects other than Mandarin (number of participants)	Beijing (1), Taiwanese (1), Hubei (1), Nanchang (3), Cantonese (1), Taizhou (1)
Age starting to learn English (number of participants)	3 (1), 4 (1), 11 (4), 12 (1), 14 (1)
Number of participants who took ESL courses (location)	7 (in Canada), 1 (in USA)

References:

- Anderson, J. (1987). The markedness differential hypothesis and syllable structure difficulty. In Ioup, G. and Weinberger, S.H. (eds.). *Interlanguage phonology: The acquisition of a second language sound system* (pp.279-291). Cambridge, MA: Newbury House Publishers.
- Benson, B. (1988). Universal preference for the open syllables as an independent process in interlanguage phonology. *Language Learning*, 38 (2): 221-235.
- Davenport, M. & Hannahs, S.J. (1998). *Introducing phonetics and phonology*. London: Arnold.
- Fant, G. (2004). *Speech acoustics and phonetics*. Dordrecht: Kluwer Academic Publishers.
- Flege, J. (1995). Speech learning in a second language. In Ferguson, C., Menn, L. and Stoel-Gammon, C. (eds.). *Phonological development* (pp.565-604). Timonium, MD: York Press.
- Hansen, J.G. (2001). Linguistic constraints on the acquisition of English syllable codas by native speakers of Mandarin Chinese. *Applied Linguistics* 22 (3): 338-365.
- Hansen, J. G. (2006). *Acquiring a non-native phonology: linguistic constraints and social barriers*. London. Continuum.
- Hayward, K. (2000). *Experimental phonetics*. Harlow: Longman.
- James, C. (1980). *Contrastive Analysis*. Harlow: Longman.
- James, C. (1988). *The acquisition of a second language phonology: A linguistic theory of developing sound structures*. Tübingen: Narr.
- Ladefoged, P., & Maddieson, I. (1996). *The sounds of the world's languages*. Cambridge: Blackwell.

- Tarone, E. (1987). Some influences on the syllable structure of interlanguage phonology. In Ioup, G. and Weinberger, S.H. (eds.). *Interlanguage phonology: The acquisition of a second language sound system* (pp.233-247). Cambridge, MA: Newbury House Publishers.
- Tarone, E. (2005). Speaking in a second language. In Hankel, Ed. *Handbook on research in second language teaching and learning* (pp.485-502). Mahwah, New Jersey: Lawrence Erlbaum Associates Publishers.

Are Lexical Bundles Stored and Processed as Single Units?

Antoine Tremblay, Bruce Derwing, and Gary Libben

University of Alberta
antoinet@ualberta.ca
www.ualberta.ca/~antoinet

ABSTRACT

This paper explores the tenability of the hypothesis that lexical bundles (i.e., frequently recurring strings of words that often span traditional syntactic boundaries) are stored and processed holistically. Three self-paced reading experiments were conducted to test the hypothesis, where sentences containing 4- and 5-word lexical bundles and their controls, which did not contain lexical bundles, were presented to participants in a word-by-word, chunk-by-chunk, and sentence-by-sentence fashion. The stimuli were controlled for token and bundle frequency, transitional probabilities and morphological and phonological complexity. In the word-by-word experiment, lexical bundle sequences were not read significantly faster than non-lexical bundle strings, thus suggesting that word-by-word presentation disrupts the facilitatory effect of bundles. However, lexical bundles and sentences containing lexical bundles were read significantly faster than their controls in the other two self-paced reading experiments as predicted by the theory.

Keywords: Psycholinguistics; Lexical-bundles; Word-by-word, chunk-by-chunk, and sentence-by-sentence self-paced reading.

1 Introduction

The term 'lexical bundle' comes from the field of corpus linguistics. It first appeared in the *Longman Grammar of Spoken and Written English* (Biber et al. 1999), a monumental work entirely based on the *British National Corpus* of 100 million words. Lexical bundles are very common continuous multi-word strings, which may span phrasal boundaries, identified as such with the help of corpora. Some instances are *I don't know whether*, *don't worry about it*, and *in the middle of the*. The concept of lexical bundles, however, goes back at least to Salem (1987) and the research he carried out on a corpus of French government texts. Butler (1997) and Altenberg (1998) subsequently employed the notion in their investigations based on Spanish and English corpora. Lexical bundles are part of a larger family of multi-word strings (continuous or discontinuous) known as formulaic sequences, which are commonly thought to be stored and processed in the mind as holistic units. Examples include greeting formulae (*how do you do?*), back-channelling formulae (*yes, I see*), phrasal verbs (*to show up*), and other constructions/patterns of different sorts ranging from the very schematic

Subject-Verb-Object construction (*He kicked the ball*) to the less schematic *Verb Noun into V-ing* pattern (*He talked her into going out with him*), and idioms -- *to put one's finger in the dike* (Croft 2001; Erman and Warren 2000; Hunston and Francis 2000; Pawley and Syder 1983; Titone and Conine 1999; Wray 2002 and references cited therein; Schmitt 2004 and references cited therein).

Wray (2002) gives us a nice overview of the history of formulaic sequences in linguistics. Their existence was noticed at least as early as the mid-nineteenth century by John Hughlings Jackson, who observed that aphasics could fluently recall rhymes, prayers, greeting formulae and so forth, whereas they could not produce novel sentences (cited in Wray 2002: 7). He was not the only scholar to detect such linguistic peculiarities. Ferdinand de Saussure (1916/1966) talked of agglutinations, that is, the unintentional fusion of two or more linguistic signs that frequently recur together into a single unanalyzed unit so as to form a short cut for the mind. Jespersen (1924) acknowledged the existence of multi-word units stored in the mind of speakers noting that language would be too difficult to manage if one had to remember every individual item separately. According to Bloomfield (1933: 181), "many forms lie on the border-line between bound forms and words, or between words and phrases". Firth, for his part, considers that the units of speech are phrases (1937/1964), and that for one to characterize a certain community's speech, one has to list the usual collocations used by its speakers, that is, the set of words that frequently recur with a particular word (1957/1968). Miller (1956) argues that our short-term memory span is limited to seven, plus or minus two units. Nonetheless, we manage to circumvent this severe limitation by organizing information into chunks. Thus, while the number of units we can process at any given time remains constant, we can significantly increase the amount of information contained in each unit and therefore increase the total amount of information we can manage. For Hymes (1962: 41), a large part of communication involves the use of recurrent patterns, that is, of "linguistic routines". Bolinger (1976: 1) maintains that "our language does not expect us to build everything starting with lumber, nails, and blueprints, but provides us with an incredibly large number of prefabs". Finally, Fillmore (1979) writes that knowing how to use formulaic utterances makes up a large part of a speaker's ability to successfully handle language. During the Chomskyan era, which started in the 1950s, formulaic language other than non-compositional idioms were marginalized, and only recently has "the idea of holistically managed chunks of language" resurfaced (Wray 2002: 8).

As just mentioned, a number of researchers recognized that certain words systematically occur with one another. However, their observations were based on perceptual salience and a number of highly frequent lexical sequences went unnoticed. Nowadays, linguists have powerful tools that enable them to reliably identify lexical sequences that recur across increasingly large amounts of spoken and written texts. More importantly, "corpus-based techniques enable investigation of new research questions that were previously disregarded because they were considered intractable" (Biber and Conrad 1999: 181). Owing to corpus-based approaches, we are not only realizing "how extensive and systematic the pattern of language use" is, but also apprehending how such "association patterns are well beyond the access of intuitions" and how they are "much too systematic to be disregarded as accidental" (Biber et al. 1999: 290). Given this systematicity, one may wonder whether formulaic sequences are stored and processed holistically. Unfortunately, very few psycholinguistic studies have considered the question of how they are stored and processed in the mind

(Schmitt 2004: viii), which, moreover, have produced mixed results. Let us briefly review these studies.

Bod (2001), using a lexical-decision task, has shown that high-frequency three-word sentences such as *I like it* were reacted to faster than low-frequency sentences such as *I keep it*. Underwood, Schmitt and Galpin (2004) used an eye-tracking paradigm to examine the processing of formulaic sequences such as *a stitch in time saves nine* and *as a matter of fact*. They found that the terminal words in formulaic sequences were processed more quickly than the same words appearing in non-formulaic contexts. These results provide evidence supporting the view according to which formulaic sequences (including high-frequency three-word sentences) are stored and processed holistically. Nevertheless, other studies failed to find processing discrepancies between formulaic and non-formulaic sequences. Schmitt and Underwood (2004) conducted a self-paced reading experiment using the same stimuli used in the Underwood, Schmitt and Galpin study, where words were flashed on the screen one-by-one. Contrary to the eye-tracking experiment, the terminal words in formulaic sequences were not processed more quickly than the same words appearing in non-formulaic contexts. Finally, in their oral recall experiment, Schmitt, Grandage, and Adolphs (2004) did not find that formulaic sequences were recalled significantly more accurately than non-formulaic sequences. In the face of such few and mixed results, the question of whether formulaic sequences are stored and processed holistically in the mind remains unresolved. If we are to elucidate this question, more research needs to be done.

In this paper we wish to advance our understanding of the mental lexicon by addressing the question of whether lexical bundles (LBs) are stored and processed holistically. We approached the question by conducting three self-paced reading experiments. The reasoning behind them is as follows. Consider for instance a sentence composed of 9 units (words). If a 4-word LB is stored and processed as a whole, a participant should merely have to compute 6 units when reading the sentence. However, non-lexical bundles (NLBs) are not stored and processed holistically, and a participant will thus have to compute 9 units. We thus compared sentences that contained LBs to equivalent sentences that did not. Our prediction was that sentences containing LBs would be read more quickly than those that did not contain LBs. In order to determine whether context is necessary for holistic processing and if so, how much of it is needed, the stimuli were presented word-by-word (experiment 1), chunk-by-chunk (experiment 2), and sentence-by-sentence (experiment 3). The three experiments are described in sections 2, 3, and 4 respectively.

2 Experiment 1

Schmitt and Underwood (2004) investigated the processing of formulaic sequences such as *by the skin of his teeth* by running a word-by-word self-paced reading experiment. They reasoned that if formulaic sequences are stored and processed holistically, the terminal word of a formulaic sequence would be read faster than the same word in a non-formulaic sequence text. They chose 20 formulaic sequences that met the following criteria:

- (i) the sequences had a relatively high frequency in the *British National Corpus* and the *Cambridge and Nottingham Corpus of Discourse in English*
- (ii) the sequences had a relatively obvious beginning (i.e., they did not begin with several function words)

- (iii) the sequences did not finish with a function word
- (iv) the sequences were 4-8 words long
- (v) the sequences were relatively predictable from their initial components

The sequences were embedded in extended contexts. Each story had one sequence and one the terminal word from a formulaic sequence from another passage. Each passage was subjected to a frequency analysis in *The Compleat Lexical Tutor v.2* to ensure that low frequency vocabulary was kept to a minimum. Finally, simple comprehension questions for each story were devised so as to ensure that participants actually read the passage. They compared reading times between terminal words appearing in formulaic sequences and terminal words occurring in non-formulaic sequence text. However, they did not find any significant difference in reading latencies. According to these authors (2004: 187), their failure to find positive results might be due to the “word-by-word nature of the task [which] disrupts the holistic processing of formulaic sequences”. Alternatively, it is possible they did not find any differences because they did not directly compare reading times between formulaic sequences and equivalent non-formulaic sequences. It is also possible that factors such as transitional probabilities — that is the probability of word W2 occurring after word W1 — washed out the gain in reading speed formulaic sequences would have provided. We thus ran a word-by-word self-paced reading experiment where reading times for lexical bundles were directly compared to nearly equivalent non-lexical bundles. This experiment is described in the following lines.

2.1 Participants

Twenty undergraduate students at the University of Alberta were paid to participate in the self-paced reading task. They were native speakers of English.

2.2 Materials

Lexical bundles (LB) were taken from Biber et al. (1999). Their respective frequency was checked against the spoken subcorpus of the *British National Corpus* using the *Variations in English Words and Phrases* search engine. Any 4-word string with a frequency of occurrence of at least 10 times per million words and any 5-word string with a frequency of occurrence of at least 5 times per million were retained as LBs (e.g., *the end of the*; frequency 112 per million).¹ Any string of words with a frequency below this threshold was considered to be a non-lexical bundle (NLB; e.g., *I see what you*; frequency 7 per million). LBs for which an appropriate NLB control string could be found were kept (20 in total). By appropriate NLB, it is meant NLB strings that met the criteria described in (1)-(4) below.

The actual stimuli consisted of 6 practice trials, 20 target sentences containing LBs paired with 20 control sentences where one word in the target LB string was changed so that it did not constitute an LB (see Appendix). That is, the control sentences differed from the target sentences in only one word. By way of example, consider the following target sentence: *But honestly, I don't think he ran away*. The underlined portion of the sentence corresponds to the LB. Compare this sentence to the following control sentence, where the underlined portion does not constitute an LB: *But honestly, I do think he ran away*. The two differ only in one

¹ This arbitrary threshold originates from Biber et al. (1999: 992-3).

word (which is called the Pivot Word, PW, in bold here), that is, “don’t” in the target and “do” in the control. In most cases, the LB and NLB strings were embedded after the second word of the sentence and were followed by two words (the mean length of the sentences was 8.6 words (SD 0.8). In an attempt to avoid confounds, various other constraints were also built into each target LB and control NLB pair:

- (1) the token frequency of the PW in the NLB was greater than that of the PW in the LB;
- (2) both the morphological and phonological complexity of the PW in the NLB string was equal to or simpler than that of the PW in the LB;
- (3) the preceding-word-to-PW probability was on average 2.4 times (SD 3.6) greater in the NLB string; and
- (4) in the perfect world, the PW-to-following-word probability would have been greater in the NLB than in the LB across the board. However, it was only possible to construct 4 NLB strings that met this criterion (on average 1.3 times greater, SD 1.3). In the other 16 pairs, the PW-to-following-word probability was on average 19.1 times greater in the LB than in the control NLB (SD 23.5).

In addition, none of the control strings contained any LBs. An effort was also made so that the rest of the sentences did not contain LBs.

2.3 *Experimental design*

The stimuli were split into two counter-balanced lists: list A and list B. Participants from group A first saw list A, had a 30-40 minute break (they did other experiments) and then saw list B, whereas participants in group B saw list B before and list A after. Note that the first list participants saw is referred to as the 1st set in the remainder of the text, and the second list as the 2nd set. The sentences were presented in a pseudo-randomized fashion. That is, the order of presentation was randomly determined but then kept constant across groups and lists. Each trial was paired up with a simple yes-no question specific to the sentence to ensure that the participants actually read and processed the sentences. The right answers to the questions were balanced (there were 20 “yes” answers and 20 “no” answers).

2.4 *Procedure*

The practice and experimental trials were presented to the participants visually using Psyscope version 1.2.5. Each practice and experimental trial consisted of the following: (i) The participants heard a beep and saw an asterisk in the centre of the screen (Font: Arial bold, Size: 100); (ii) when ready, the participants pressed a key to see a sentence (Position: centred, Font: Arial, Size: 48); (iii) once the participants had finished reading the sentence, they pressed a key; (iv) then the participants heard a beep and saw three asterisks in the centre of the screen for 1000 ms (Position: centred, Font: Arial, Size: 48); (v) the word “Question:” appeared in the centre of the screen (Font: Arial bold; Size: 48) for 1000 ms, and

then the question as such appeared (Position: centre; Font: Arial bold; Size: 36); and (vi) the participant answered the question by using the “y” key for ‘yes’ and “n” key for ‘no’. Once they pressed either the “y” or “n” key, the next trial started. An example of a trial block is shown in (5).

(5) Word-by-word presentation

- a. Target: *He's - glad - you - **don't**- want - to - dig - tunnels.*
 Question: *He doesn't want to dig tunnels, right*
 Answer: *Yes*
- b. Control: *He's - glad - you - **do**- want - to - dig - tunnels.*
 Question: *Is he sad?*
 Answer: *No*

In (5), the underlined portion of each example corresponds to the LB and NLB strings and the word in bold is the PW.

2.5 Results

Only the LB and NLB strings were taken into account. Trials involving wrong answers to the questions were eliminated as well as those with reading times three standard deviations above or under the mean. Overall, 5.2% (86/1,665 trials) were thrown out. Regarding the by-subject analysis, a 2 x 2 repeated measures analysis of variance (ANOVA) was performed on the trimmed data for the 1st and 2nd sets (group x lexical-bundlehood). The results of the analyses are given in Table 1.

Table 1

Experiment 1, 1st and 2nd sets: By-subject repeated measures ANOVA.

Set	LBhood	Mean RT	(SD)	Difference	<i>F</i> (1, 18)	<i>p</i>
1	LB	576	(383)			
1	NLB	610	(390)	34	8.1	< 0.05
2	LB	376	(191)			
2	NLB	380	(197)	4	0.7	> 0.05

In the 1st set, the 34 ms difference in summed reading times between LB segments and NLB ones was significant [$F(1, 18) = 8.1, p < 0.05$]. The 4 ms difference in summed reading times in the 2nd set, however, did not reach significance [$F(1, 18) = 0.7, p > 0.05$]. Moreover, the interaction between group and lexical-bundlehood in the 1st set was not significant [$F(1, 18) = 0.6, p > 0.05$] but the interaction was significant in the 2nd set [$F(1, 18) = 4.4, p < 0.05$] (not shown in Table 1).

Regarding the by-item analysis, a paired *t*-test was performed on the trimmed data (LBs vs. NLBs) for each set. The results of the analyses are shown in Table 2.

Table 2Experiment 1, 1st and 2nd sets: By-item paired *t*-test analysis.

Set	LBhood	Mean RT	(SD)	Difference	<i>t</i> (19)	<i>p</i>
1	LB	583	(38)			
1	NLB	613	(83)	38	-1.5	> 0.05
2	LB	381	(43)			
2	NLB	379	(50)	2	0.1	> 0.05

There were no significant differences in reading times in either set [$t(19) = -1.5, p > 0.05$; $t(19) = 0.1, p > 0.05$ respectively].

Given that the 2nd set by-subject analysis and both the 1st and 2nd set by-item analyses reveal insignificant differences in reading times, it is considered that a type II error was committed in the significant 1st set by-subject analysis (i.e., we failed to reject the null hypothesis when it was false). In brief, the statistical tests presented here show that LB sequences are not read significantly faster than NLB strings.

2.6 Discussion

Though there were no differences in reading times between LB and NLB sequences, it is possible that an LB facilitatory effect occurs in the word following the LB/NLB strings. Let [W] be the word that a participant is currently reading, [W+1] the word following it, and [W-1], [W-2], ..., [W-n] words occurring before word [W]. Possibly, participants press a key to see word [W+1] even though they have not finished integrating word [W] to the previous word sequence [W-n, W-2, W-1]. That is, if there is processing spill-over and if LBs are processed faster than NLBs, then there should be less spill-over at word [W+1] and these words should be read faster after LBs than NLBs. It is important to mention that word [W+1] is the same after both LBs and NLBs (cf. (6)), where the LB/NLB appears in bold and the word following them is underlined).

- (6) a. Target: If workers **don't worry about it** nothing will happen.
 b. Control: *If workers **don't know about it** nothing will happen.*

A by-subject repeated measures ANOVA and a by-item paired *t*-test — summarized in Tables 3 and 4 — were performed on RTs associated with the word following LB/NLB strings for both sets.

Table 3.Experiment 1, 1st and 2nd sets: By-subject analysis of the word following LB and NLB strings.

Set	LBhood	Mean RT	(SD)	Difference	<i>F</i> (1, 18)	<i>p</i>
1	LB	612	(349)			
1	NLB	670	(423)	58	8.3	< 0.05
2	LB	404	(200)			
2	NLB	423	(243)	19	1.7	> 0.05

Table 4.Experiment 1, 1st and 2nd sets: By-item analysis of the word following LB and NLB strings.

Set	LBhood	Mean RT	(SD)	Difference	<i>t</i> (119)	<i>p</i>
1	LB	618	(92)			
1	NLB	684	(141)	66	-2.0	> 0.05
2	LB	404	(67)			
2	NLB	427	(83)	23	-0.8	> 0.05

There was a significant main effect of lexical-bundlehood in the by-subject analysis for the 1st set [$F(1, 18) = 8.3, p < 0.05$]. However, the by-subject analysis for the 2nd set did not yield any significant differences [$F(1, 18) = 1.7, p > 0.05$] neither were there any significant differences in the by-item analyses for the 1st set [$t(19) = -2.0, p > 0.05$] nor the 2nd set [$t(19) = -0.8, p > 0.05$]. Similarly to the analysis performed on the summed RTs for the LB and NLB sequences, it will be considered that a type II error was committed in the 1st set by-subject analysis. In sum, the word following an LB sequence was not read significantly faster than words following NLBs.

What if the integration process was resolved at the last word of the sentences? If this is the case, the LB facilitatory effect might only be apparent in RTs associated with this word. That is, the last word of a sentence would be read faster when the sentence would contain an LB than when it would not. A by-subject repeated measures ANOVA and a by-item paired *t*-test was performed on RTs associated with the last word of the sentences. The results of these analyses are summarized in Tables 5 and 6.

Table 5.Experiment 1, 1st and 2nd sets: By-subject analysis of the last word of sentences.

Set	LBhood	Mean RT	(SD)	Difference	<i>F</i> (1, 18)	<i>p</i>
1	LB	851	(637)			
1	NLB	919	(710)	68	2.6	> 0.05
2	LB	521	(383)			
2	NLB	506	(332)	15	0.6	> 0.05

Table 6.Experiment 1, 1st and 2nd sets: By-item analysis of the last word of sentences.

Set	LBhood	Mean RT	(SD)	Difference	<i>t</i> (119)	<i>p</i>
1	LB	840	(184)			
1	NLB	960	(251)	120	-1.5	> 0.05
2	LB	530	(156)			
2	NLB	481	(104)	49	0.9	> 0.05

Neither the by-subject [1st set: $F(1, 18) = 2.6, p > 0.05$; 2nd set: $F(1, 18) = 0.6, p > 0.05$] or the by-item analyses [1st set: $t(19) = -1.5, p > 0.05$; 2nd set: $t(19) = 0.9, p > 0.05$] reach significant differences in RT between last words in sentences that contain LBs and those that do not. The data suggests that LBs do not procure any processing advantage over NLBs.

However, it is possible that the task is not picking up the advantage in processing time of LBs by virtue of the sentences being presented in a word-by-word fashion. If this is right, pivot words (PWs) in control strings should not be read faster than pivot words (PW) in target sequences. Indeed, it is well known that more frequent words are processed faster than

less frequent words (Taft 1979; Reichle et al. 2003). Note that all of the control PWs were more frequent than target PWs [on average 2.5 times more frequent; mean frequency PWs in LBs = 3,144 per million, SD = 4,108; mean frequency PWs in NLBs = 7,927 per million, SD = 6,239]. A by-subject repeated measures ANOVA and a paired *t*-test for each set were performed on the RTs associated with the PW. The summary of the analyses is given in Tables 7 and 8.

Table 7.Experiment 1, 1st and 2nd sets: By-subject analysis of the pivot word.

Set	LBhood	Mean RT	(SD)	Difference	<i>F</i> (1, 18)	<i>p</i>
1	LB	573	(356)			
1	NLB	619	(417)	46	6.3	< 0.05
2	LB	384	(201)			
2	NLB	372	(208)	15	1.4	> 0.05

Table 8.Experiment 1, 1st and 2nd sets: By-item analysis of the pivot word.

Set	LBhood	Mean RT	(SD)	Difference	<i>t</i> (119)	<i>p</i>
1	LB	577	(47)			
1	NLB	614	(99)	37	-1.6	> 0.05
2	LB	389	(51)			
2	NLB	374	(56)	15	0.7	> 0.05

As in previous analyses, the 1st by-subject ANOVA is significant [$F(1, 18) = 6.3, p < 0.05$] whereas the 2nd set by-subject [$F(1, 18) = 0.7, p > 0.05$] as well as the 1st and 2nd sets by-item [1st set: $t(19) = -1.6, p > 0.05$; 2nd set: $t(19) = 0.7, p > 0.05$] analyses are not significant. Again, given that the significance of the by-subject analysis in the 1st set is not backed-up by the other analyses, it will be considered that a type II error was committed. In brief, though PWs in control sentences should have been read faster than PWs in target sentences by virtue of their being more frequent, this well known effect was not observed here.

In conclusion, the word-by-word self-paced experiment failed to produce reliable significant differences in reading times between LB and NLB sequences as well as between words immediately following them and sentence-final words.² According to the results presented here, LBs do not procure any processing advantage over NLBs. Nonetheless, PWs in controls were not read significantly faster than PWs in targets, as would have been expected, thus indicating that word-by-word self-paced reading experiments are not reliable techniques when it comes to measuring frequency effects. It is true that reading sentences word-by-word is very unusual and this precisely might be the reason why no effect was found (if there is one to be found). What if the stimuli were presented in a more natural manner, such as sentence-by-sentence or even in a slightly less natural fashion, chunk-by-chunk? Experiments 2 and 3 investigate this question.

² By reliable it is meant that the majority of by-subject and by-item analyses are significant, where a completely reliable significant difference would mean that the by-subject and by-item analyses in both sets are significant. The difference in reading time between LBs and NLBs in experiment 1 were not reliable because only the by-subject analysis of the 1st set was significant, whereas the by-subject analysis of the 2nd set and the two by-item analyses in the two sets were not significant.

3 Experiment 2

No differences in reading time between LBs and NLBs were found in the word-by-word self-paced reading experiment. Apparently, the nature of the task was at fault. The chunk-by-chunk self-paced experiment reported in this section aims at determining simultaneously (i) whether there is an LB facilitatory effect in on-line sentence processing, and (ii) whether the lack of positive findings in experiment 1 is really due to the manner of presentation of the stimuli.

3.1 Participants

Same as in experiment 1. None of them had done experiment 1.

3.2 Materials

Same as in experiments 1.

3.3 Experimental design

Same as in experiments 1.

3.4 Procedure

Same as experiments 1, except that the stimuli were presented in a chunk-by-chunk fashion. An example of a trial block is shown in (7).

(7) Chunk-by-chunk presentation

- a. Target: *He's glad - you **don't** want to - dig tunnels.*
Question: *He doesn't want to dig tunnels, right?*
Answer: *Yes*
- b. Control: *He's glad - you **do** want to - dig tunnels.*
Question: *Is he sad?*
Answer: *No*

As before, the underlined portion of each example corresponds to the LB and NLB strings and the word in bold to the PW.

3.5 Results

Only the LB and NLB chunks were taken into account. Trials involving wrong answers to the questions were eliminated as well as those with reading times three standard deviations above or under the mean. Overall, 13.4% (107/1,665 trials) were thrown out. Regarding the by-subject analysis, a repeated measures 2 x 2 ANOVA was performed on the trimmed data for the 1st and 2nd sets (group x lexical-bundlehood). The results of the analysis are given in Table 9.

Table 9Experiment 2, 1st and 2nd sets: By-subject repeated measures ANOVA.

Set	LBhood	Mean RT	(SD)	Difference	$F(1, 18)$	p
1	LB	1,269	(632)			
1	NLB	1,508	(542)	239	6.8	< 0.05
2	LB	914	(317)			
2	NLB	1,153	(525)	239	11.9	< 0.05

LB chunks were read 239 ms faster than NLB chunks both in the 1st [$F(1, 18) = 6.8, p < 0.05$] and 2nd sets [$F(1, 18) = 8.1, p < 0.05$]. Moreover, the interaction between group and lexical-bundlehood in the 1st set did not reach significance [$F(1, 18) = 0.6, p > 0.05$] but the interaction was significant in the 2nd set [$F(1, 18) = 5.3, p < 0.05$] (not shown in Table IX).

Regarding the by-item analysis, a paired t -test analysis was performed on the trimmed data (LBs vs. NLBs) for each set. The results of the analysis are shown in Table X.

Table 10.Experiment 2, 1st and 2nd sets: By-item paired t -test analysis.

Set	LBhood	Mean RT	(SD)	Difference	$t(119)$	p
1	LB	1,265	(400)			
1	NLB	1,505	(415)	240	-1.7	< 0.05
2	LB	923	(140)			
2	NLB	1,157	(304)	234	-4.0	< 0.05

The 240 ms difference between LB and NLB chunks in the 1st set did not reach significance, though there is a trend for LB chunks to be read faster than NLB chunks [$t(119) = -1.7, p > 0.05$]. However, the 234 ms difference in the 2nd set did reach significance [$t(119) = -4.0, p < 0.05$].

In brief, given that the 1st and 2nd by-subject and the 2nd set by-item analyses were significant, and given the trend seen in the 1st set by-item analysis in favour of LB chunks, it is concluded that LB chunks were read significantly faster than NLB chunks. These findings also suggest that word-by-word presentation of stimuli in self-paced reading experiments does disrupt the advantage in processing time LBs have over NLBs.

Given these findings, it is predicted that sentences containing LBs in the sentence-by-sentence self-paced reading experiment will be read more quickly than sentences that do not contain LBs. But how reliable and how large will the effect be compared to the one found in experiment 2 (if there is one to be found)?

4 Experiment 3

4.1 Participants

Same as in experiments 1 and 2. None of them had done experiments 1 or 2.

4.2 Materials

Same as in experiments 1 and 2.

4.3 Experimental design

Same as in experiments 1 and 2.

4.4 Procedure

Same as experiments 1 and 2, except that the stimuli were presented in a sentence-by-sentence fashion. An example of a trial block is shown in **Erreur ! Source du renvoi introuvable.**

(8) Sentence-by-sentence presentation

- a. Target: *He's glad you don't want to dig tunnels.*
Question: *He doesn't want to dig tunnels, right?*
Answer: *Yes*
- b. Control: *He's glad you do want to dig tunnels.*
Question: *Is he sad?*
Answer: *No*

The underlined portion in each example corresponds to the LB and NLB strings and the word in bold to the PW.

4.5 Results

As in the other two experiments, trials involving wrong answers to the questions were eliminated as well as those with reading times three standard deviations above or under the mean. Overall, 8.5% (68/800 trials) were thrown out. Regarding the subject analysis, a 2 x 2 repeated measures ANOVA was performed on each set (group x lexical bundlehood). The results are summarized in Table 11.

Table 11

Experiment 3, 1st and 2nd sets: By-subject repeated measures ANOVA.

Set	LBhood	Mean RT	(SD)	Difference	$F(1, 18)$	p
1	LB	4,335	(1,194)			
1	NLB	5,031	(1,631)	696	17.6	< 0.05
2	LB	3,406	(1,080)			
2	NLB	4,097	(1,487)	691	8.5	< 0.05

The results show that sentence containing LBs were read 696 ms faster than sentences that did not contain LBs in the 1st [$F(1, 18) = 17.6, p < 0.05$] and 691 ms faster in the 2nd sets [$F(1, 18) = 8.5, p < 0.05$]. Though the interaction between lexical-bundlehood and group in the 1st set was significant [$F(1, 18) = 4.6, p < 0.05$], it did not reach significance in the 2nd set [$F(1, 18) = 0.3, p > 0.05$] (not shown in Table 11).

Regarding the by-item analysis, a paired *t*-test analysis was performed on the trimmed data (LBs vs. NLBs) for each set. The results of the analyses are shown in Table 12.

Table 12Experiment 3, 1st and 2nd sets: By-item paired t-test analysis.

Set	LBhood	Mean RT	(SD)	Difference	<i>t</i> (119)	<i>p</i>
1	LB	4,332	(987)			
1	NLB	5,122	(1,087)	790	-2.7	< 0.05
2	LB	3,393	(477)			
2	NLB	4,192	(1,192)	799	-2.6	< 0.05

In the 1st set, the 790 ms difference between sentences that contain LBs and those that do not was significant [$t(19) = -2.7, p < 0.05$], as well as the 799 ms difference in the 2nd set [$t(19) = -2.6, p < 0.05$]. In sum, the by-subject and by-item analyses reveal that LBs provide an advantage in on-line sentence processing.

4.6 Discussion

Counter to our earlier prediction, the magnitude of the LB facilitatory effect in experiment 3 was about 3 times bigger (mean difference = 744 ms) than the one found in experiment 2 (mean difference = 238 ms). This is unexpected given that words before and after LBs and NLBs should have been read equally fast given that they are exactly the same. This suggests the existence of some kind of synergy between LBs and natural, full-sentence context.

5 General discussion

These results obtained in experiments 2 and 3 parallel results obtained for other self-paced reading experiments that tried to determine whether formulaic sequences (other than LBs) were stored and processed holistically. Ortony, Schallert, Reynolds, and Antos (1978) found that idioms used figuratively were understood more quickly than idioms used literally, thus suggesting that the meaning of an idiom is stored like the meaning of single words. Gibbs, Bogdanovich, Sykes, and Barr (1997) also found in their self-paced reading paradigm that idioms were read faster than control non-idioms. Finally, Conklin and Schmitt (to appear) also used a self-paced reading experiment in their study of formulaic sequences such as *everything but the kitchen sink* and *a breath of fresh air*, which were embedded in passages and presented in a line-by-line fashion. They found that formulaic sequences were processed faster than non-formulaic sequences.

One possible explanation for the fact that LBs are read faster than NLBs is that LBs — like idioms and other formulaic sequences such as *everything but the kitchen sink* — are stored and processed holistically. This, however, is only one of other possible explanations. Storage, as Harald Baayen (p.c.) would say, might simply be combinatorial knowledge, that is, knowledge of what goes with what. Therefore, it is possible that transitional probabilities — that is, the higher likelihood of occurrence for a lexical item after one or more previous lexical items, or as Gary Libben (p.c.) would say, knowing where one is going given knowledge of where one was — underlies the facilitatory effect. First-order transitional probabilities (i.e., $W1 \rightarrow W2 \rightarrow W3$) were controlled for and this variable did not affect reading times, otherwise NLBs would have been read faster than LBs. Similarly, in their study of idioms Swinney and Cutler (1979) did not find a transitional probability advantage

for idioms over controls. However, it is possible that second-order transitional probabilities (i.e., $W1, W2 \rightarrow W3$ or the probability of occurrence of word $W3$ after word $W1$ and word $W2$ have occurred) or even third-order transitional probabilities (i.e., $W1, W2, W3 \rightarrow W4$ or the probability of occurrence of word $W4$ after word $W1$, word $W2$, and word $W3$ have occurred) underlie the LB effect. Yet another possibility is that LBs are stored both with and without internal structure.

That LBs are holistically stored without internal structure finds support from the first-language acquisition literature (e.g., Ellis 1996, 1998; Wray 2002). A significant body of research suggests that (at least some) children first learn chunks and then decompose them at a later stage into smaller units. By way of example, a friend's one-and-a-half year old named Erin loves a game where her mother Tracy tries to catch her. Every time Tracy would initiate the game she would say "I'm gonna catch you" and then run after Erin. After some time, Erin developed the habit of initiating the game herself. She would go up to her mother and say "I'm gonna catch you" and then run away in the hopes that Tracy would play the game. Clearly, Erin has associated the whole string of sounds "I'm gonna catch you" with the meaning "let's play the game where you try to catch me". She has evidently learned it and uses it as a non-decomposed, holistic unit without internal structure; otherwise she would probably replace the 1st person subject with a 2nd person subject, change the verb from "am" to "are", and replace the 2nd person object with a 1st person object so as to say something like "you're gonna catch me". The point to be made here is that at least some more or less complex linguistic units we have in our mental lexicon, which were acquired during the (very) early stages of our lives, have to have a holistic entry node (if that's how things are stored in our brain) without internal structure. Otherwise, Erin would not have used the sequence "you're gonna catch me" to initiate the game.

Nonetheless, humans seem to be very powerful pattern finders (Bowers, Davis, and Hanley 2005), and in order to find patterns, we must decompose, analyse things. For example, Libben (1994, 1998, 2005b) and Libben and de Almeida (2002) have found that compound-word decomposition is automatic and obligatory. Coming back to our earlier example, Erin has certainly decomposed the string "I'm gonna catch you" but at the time she had insufficient data and experience with the language so as to build up in her mental lexicon smaller interrelated entries "I'm", "gonna", "catch", "you". Nonetheless, with time and experience these entries would eventually be created and she would know that these words go together.

If every linguistic unit is automatically decomposed, whether it be holistically stored or not, then how can we account for differences in processing time between an LB and a NLB? Instead of saying that LBs are holistically retrieved as opposed to NLBs — in other words, that NLBs are decomposed but not LBs — Libben (2005b: 276) would suggest that the difference is attributable to LBs being processed less than NLBs. Using functional magnetic resonance imaging (fMRI), Bischoff-Grether et al. (2000) found a negative correlation between activation of Wernicke's area and its right homologue and predictability of nonverbal sequences. In other words, the less predictable a sequence was, the more activation there was in Wernicke's area and its right homologue, whereas more predictable sequences correlated with less activation of these areas. Assuming that predictability is tantamount to frequency of occurrence, this finding relates to LBs in the following way. LBs are highly recurrent (predictable) strings of words, while NLBs are non-recurrent and unpredictable (at least compared to LBs). The on-line processing advantage LBs have over NLBs might reside

in that LBs incur less activation of Wernicke's area than NLBs. Though Wernicke's area and its right homologue are possibly related to the processing of LBs and NLBs alike, it is still unclear in what respect LBs are processed to a lesser degree than NLBs.

Baayen (2003: 266) mentions that "if the brain does indeed make use of probabilities, then it must somehow keep track of (relative) frequency information". In other words, each time a linguistic unit is encountered, the brain (automatically) reinforces it, thus increasing its initial activation (i.e., its frequency). Processing differences might be attributable (at least in part) to this reinforcement process, which might be the building of neural pathways. Assuming that a particular linguistic unit needs to be accessed in order for it to be reinforced, less frequent linguistic units should be harder to reinforce than more frequent ones given that less frequent words are processed slower than more frequent ones (Wingfield 1968; Taft 1968; Reichle et al. 2003). If this has any claim to reality, then, LBs would demand a lesser quantity of blood to flow to relevant parts of the brain in order to reinforce them than NLBs and this difference in blood quantity would correlate with a difference in reading time.

6 Conclusion

The results of the chunk-by-chunk and sentence-by-sentence self-paced reading experiments reported here show that LBs and sentences containing LBs are read faster than NLBs and sentences that do not contain LBs. This suggests that LBs facilitate on-line sentence processing. Note that these results occurred despite the fact that NLB control strings should have been read faster according to measures known to facilitate processing such as token frequency, morphological and phonological complexity, and transitional probabilities. The decisive factor here was lexical-bundlehood, that is, whether a string of words was an LB or not. In the word-by-word experiment, however, there were no significant differences in reading time between LBs and NLBs, similarly to Schmitt and Underwood's (2004) word-by-word self-paced reading experiment. This indicates that word-by-word presentation of LBs disrupts their facilitatory effect.

To answer the question posed in the title of this paper, the LB effect observed in experiments 2 and 3 can be accounted for by holistic storage. Nonetheless, it is still unclear how exactly is the term 'stored' defined. On the one hand, 'stored' could mean that the words making up the LB are individual items that are linked together through combinatorial knowledge (i.e., knowing that they go together), whereas NLBs would not benefit from such knowledge. From this perspective, a stored LB, for instance *in the middle of the*, would look something like the following: [in→the→middle→of→the]. On the other hand, 'stored' could also mean that an LB has no internal structure and would look something like [inthemiddleofthe]. Further research is needed to determine what exactly is storage. Perhaps, the best way to discriminate between holistic and non-holistic storage is through speech production. I have heard a few times people repetitively say "The problem is is that"; it seems that the string "the problem is" is retrieved as a non-analysed, holistic chunk. Otherwise, they would have felt the ungrammaticalness of the double "is" and omitted one of them in subsequent productions. It seems, however, that they did not feel this sequence was problematic given that they kept using it.

One last point needs mentioning. It is widely assumed in the formulaic sequences literature that these entities are linked to specific discourse functions and usually appear in certain positions in a sentence. For instance, the sequence *you know what I mean* would appear at the end of a sentence in order to request feedback. Regarding lexical bundles more specifically, Biber et al. (2003) have developed a taxonomy to classify the discourse functions of LBs found in the conversation and academic prose subcorpora of the *British National Corpus*. However, the LBs used here were not embedded in their usual place within a sentence and as such did not carry the discourse functions they have been said to portray, if any at all. This suggests that even though LBs might bear more often than not a set of specific discourse functions, there is no inherent association between the two.

Acknowledgments

This paper is supported by a Major Collaborative Research Initiative Grant (#412-2001-1009) and a Doctoral Fellowship (#752-2006-1315) from the Social Sciences and Humanities Research Council of Canada (SSHRC). We wish to acknowledge the contribution John Newman made to this paper via his LING 519 *Corpus Linguistics* course, where the first author learned many very useful skills and read many enlightening papers, as well as Harald Baayen for many insightful discussions on the subject matter.

Appendix . Stimuli

Item	Code	4 or 5 word Seq.	LB = 1; NLB = 2	Practice Trials	Question	Correct Answer
pt1	pt1		2	I had the flu but I still went to class.	Was I sick?	y
pt2	pt2		2	Information can travel across the globe in seconds.	Can information can't travel across the globe?	y
pt3	pt3		2	A year ago, Mr. Jones started to sell electronic games.	Was it Mr. Smith who started selling games?	n
pt4	pt4		2	The man was found in a hotel off route 99.	Did they find the man?	y
pt5	pt5		2	I bought this book in the new bookstore.	Did he buy a knife?	n
pt6	pt6		2	The other day I slept like a log.	Does the sentence mention anything about a rabbit?	n
Group A 1st Set						
1	1nlb1	4	2	His friend's got one to do next Friday.	Is there a weekday mentioned in the sentence?	y
2	1nlb2	4	2	If workers don't know about it nothing will happen.	Does the sentence mention workers?	y
3	1lb3	5	1	Ron thinks you want me to do another one.	Is there an animal mentioned in the sentence?	n
4	1lb4	4	1	Yeah although you might as well buy one.	Should he borrow one?	n
5	2lb1	4	1	Tell me when you want me to return it.	Does the sentence say anything about returning something?	y
6	2nlb2	4	2	Would he like to stop and have to look inside it?	Does the sentence mention anything about stopping?	y
7	2lb3	4	1	Yes, everything I said to her was sacred.	Was everything he said ordinary?	n
8	2lb4	5	1	I sat in the middle of the bullet train.	Did I sit in an underground train?	n
9	2nlb5	5	2	But unfortunately all the top of it kept burning.	Did it keep burning?	y
10	3nlb1	4	2	He's glad you do want to dig tunnels.	Is he sad?	n
11	3lb10	5	1	Now, must I tell you what I discovered yesterday?	Is the sentence about walking?	n

12	3nlb11	4	2	I might, I do if you seriously care.	Is there a possibility that he will do it?	y
13	3lb2	4	1	But honestly, I don't think he ran away.	Does the sentence mention anything about eating?	n
14	3nlb3	4	2	Yeah, maybe I'll get you what these guys want.	Is the sentence about getting something?	y
15	3nlb4	4	2	He believes you do know what David did.	Does he believe you know?	y
16	3nlb5	4	2	Sam assumes you know where you begin singing.	Is the sentence about donuts?	n
17	3lb6	4	1	Indeed, whatever you think about it feels weird.	Is the thing pleasant?	n
18	3lb7	4	1	I confess I don't know what Smith wants.	Did the person confess?	y
19	3nlb8	4	2	I admit I do know whether Jack cheated.	Does the person know whether Jack cheated?	y
20	3lb9	5	1	I realize I don't know how research is done.	Is the sentence about skiing?	n

Group A 2nd Set

1	1lb1	4	1	His friend's got nothing to do next Friday.	Does his friend have something to do?	n
2	1lb2	4	1	If workers don't worry about it nothing will happen.	If workers don't worry, will something happen?	n
3	1nlb3	5	2	Ron thinks you want it to do another one.	Is there a man named Ron in the sentence?	y
4	1nlb4	4	2	Yeah, although you would as well buy one.	Should he buy one?	y
5	2nlb1	4	2	Tell me when you see me to return it.	Will he return it next week?	n
6	2lb2	4	1	Would he like to stop and have a look inside it?	If he stops, will he buy something?	n
7	2nlb3	4	2	Yes, everything I was to her was sacred.	Was he sacred to her?	y
8	2nlb4	5	2	I sat in the front of the bullet train.	Was sitting in the train?	y
9	2lb5	5	1	But unfortunately all the rest of it kept burning.	Did it stop burning?	n
10	3lb1	4	1	He's glad you don't want to dig tunnels.	He doesn't want to dig tunnels, right?	y
11	3nlb10	5	2	Now, must I get you what I discovered yesterday?	Is the sentence about a discovery?	y
12	3lb11	4	1	I might, I mean if you seriously care.	Does the sentence mention a country?	n
13	3nlb2	4	2	But honestly, I do think he ran away.	Does he think the man ran away?	y
14	3lb3	4	1	Yeah, maybe I'll tell you what these guys want.	Does the sentence mention ducks?	n

15	3lb4	4	1	He believes you don't know what David did.	Is the man called Patrick?	n
16	3lb5	4	1	Sam assumes you know when you begin singing.	Does the sentence mention something about Sam?	y
17	3nlb6	4	2	Indeed, whatever you do about it feels weird.	Is the sentence about feelings?	y
18	3nlb7	4	2	I confess I do know what Smith wants.	Does the sentence mention a brand name?	n
19	3lb8	4	1	I admit I don't know whether Jack cheated.	Does he know if he cheated?	n
20	3nlb9	5	2	I realize I do know how research is done.	Does he know how it is done?	y

References

- Altenberg, B. (1998). On the phraseology of spoken English: The evidence of recurrent word-combinations. In A. P. Cowie (ed.). *Phraseology: Theory, Analysis, and Applications* (pp. 101-22). Oxford: Clarendon Press.
- Baayen, R. H. (2003). Probabilistic approaches to morphology. In R. Bod, J. Hay, and S. Jannedy (eds.). *Probabilistic Linguistics*, pp. 229-88. Cambridge, MA: The MIT Press.
- Biber, D. (1999). Investigating language use through corpus-based analyses of association patterns. In M. Barlow and S. Kemmer (eds.). *Usage Based Models of Language* (pp. 287-313). Stanford, CA: CSLI Publications.
- Biber, D. and Conrad, S. (1999). Lexical bundles in conversation and academic prose. In H. Hasselgård and S. Oksefjell (eds.). *Out of Corpora: Studies in Honour of Stig Johansson* (pp. 181-190). Amsterdam and Atlanta: Rodopi.
- Biber, D., Conrad, S., and Cortes, V. (2003). Lexical bundles in speech and writing: An initial taxonomy. In A. Wilson, P. Rayson, and T. McEnery (eds.). *Corpus Linguistics by the Lune* (pp. 71-93). Frankfurt/Main: Peter Lang.
- Biber, D., Johansson, S., Leech, G., Conrad, S. and Finegan, E. (1999). *Grammar of Spoken and Written English*. Harlow: Longman.
- Bischoff-Grethe, A., Proper, S. M., Mao, H., Daniels, K. A., and Gregory S. B. (2000). Conscious and unconscious processing of nonverbal predictability in Wernicke's area. *The Journal of Neuroscience*, 20, 1975-81.
- Bloomfield, L. (1933). *Language*. New York: Henry Holt and Company.
- Bod, R. (2001). *Sentence Memory: Storage vs. Computation of Frequent Sentences*. Retrieved on October 29, 2006 at <http://staff.science.uva.nl/~rens/cuny2001.pdf>.
- Bolinger, D. (1976). Meaning and memory. *Forum Linguisticum*, 1, 1-14.
- Bowers, J. S., Davis, C. J., and Hanley, D. A. (2005). Automatic semantic activation of embedded words: Is there a "hat" in "that"? *Journal of Memory and Language*, 53, 131-43.
- Butler, C.S. (1997). Repeated word combinations in spoken and written text: Some implications for Functional Grammar. In C.S. Butler, J.H. Connolly, R.A. Gatward, and R.M. Vismans (eds.). *A Fund of Ideas: Recent Developments in Functional Grammar* (pp. 60-77). Amsterdam: IFOTT, University of Amsterdam.
- Conklin, K. and Schmitt, N. (to appear). Formulaic sequences: Are they processed more quickly than nonformulaic language by native and nonnative speakers? *Applied Linguistics*.
- Croft, W. (2001). *Radical Construction Grammar. Syntactic Theory in Typological Perspective*. Oxford: Oxford University Press.
- Ellis, N. C. (1998). Emergentism, connectionism and language learning. *Language Learning*, 48, 631-64.
- Ellis, N. C. (1996). Sequencing in SLA. Phonological memory, chunking, and points of order. *Studies in Second Language Acquisition*, 18, 91-126.
- Erman, B. and Warren, B. (2000). The idiom principle and the open choice principle. *Text*, 20, 29-62.
- Fillmore, C. (1979) On fluency. In Charles Fillmore, D. Kempler, and S.-Y.W. Wand (eds.). *Individual Differences in Language Ability and Language Behaviour* (pp. 85-101). New York: Academic Press.

- Firth, J.R. (1937/1964). *The Tongues of Men and Speech*. London: Oxford University Press.
- Firth, J.R. (1957/1968). A synopsis of linguistic theory, 1930-1955. *Studies in Linguistic Analysis: Special Volume of the Philological Society* (pp. 1-32). Oxford: Blackwell. Reprinted in F.R. Palmer (ed.). *Selected Papers of J.R. Firth 1952-59*, (pp. 168-205). Harlow: Longman.
- Gibbs, R. W., Bogdanovich, J. M., Sykes, J. R., and Barr, D. J. (1997). Metaphor in idiom comprehension. *Journal of Memory and Language*, 37, 141-154.
- Hughlings Jackson, J. (1866). Notes on the physiology and pathology of language. In J. Taylor (ed.). *Selected Writings of John Hughlings Jackson, vol. 2* (pp. 121-128). London: Staples Press.
- Hunston, S. and Francis, G. (2000). *Pattern Grammar. A Corpus-Driven Approach to the Lexical Grammar of English*. Amsterdam and Philadelphia: John Benjamins.
- Hymes, D. H. (1962). The ethnography of speaking. In *Anthropology and Human Behaviour*, (pp. 13-53). Washington, D.C.: The Anthropological Society of Washington.
- Jerpersen, O. (1924). *The Philosophy of Grammar*. London: George Allen and Unwin.
- Libben, G. (2005a). Why study compound processing? An overview of the issues. In G. Libben and G. Jarema (eds.). *The Representation and Processing of Compound Words*, pp. 11-37. Oxford: Oxford University Press.
- Libben, G. (2005b). Everything is psycholinguistic: Material and methodological considerations in the study of compound processing. *Canadian Journal of Linguistics*, 50, 267-84.
- Ortony, A., Schallert, D. L., Reynolds, R. E., and Antos, S. J. (1978). Interpreting metaphors and idioms: some effects of context on comprehension. *Journal of Verbal Language and Verbal Behaviour*, 17, 465-477.
- Pawley, A. and Syder, F. H. (1983). Two puzzles for linguistic theory: Nativelike selection and nativelike fluency. In J. C. Richards and R. W. Schmidt (eds.). *Language and communication* (pp. 191-226). New York: Longman.
- Reichle, E. D., Rayner, K., and Pollatsek, A. (2003). The E-Z Reader model of eye-movement control in reading: Comparisons to other models. *Behavioral and Brain Sciences* 26, 445-526.
- Salem, A. (1987). *Pratique des Segments Répétés*. Paris : Institut National de la Langue Française.
- Saussure, F. (1916/1966). *Course in General Linguistics*. New York: McGraw-Hill.
- Schmitt, N. (2004). *Formulaic Sequences*. Amsterdam and Philadelphia: John Benjamins.
- Schmitt, N., Grandage, S., and Adolphs, S. (2004). Are corpus-derived recurrent clusters psychologically valid? In N. Schmitt (ed.). *Formulaic Sequences* (pp. 127-151). Amsterdam and Philadelphia: John Benjamins.
- Schmitt, N. and Underwood, G. (2004). Exploring the processing of formulaic sequences through a self-paced reading task. In N. Schmitt (ed.). *Formulaic Sequences*, pp. 171-89. Amsterdam and Philadelphia: John Benjamins.
- Schweigert, W. A. and Moates, D. R. (1988). Familiar idiom comprehension. *Journal of Psycholinguistic Research*, 17, 281-296.
- Swinney, D. A. and Cutler, A. (1979). The access and processing of idiomatic expressions. *Journal of Verbal Learning and Verbal Behaviour*, 18, 522-534.
- Taft, M. (1979). Recognition of affixed words and the word frequency effect. *Memory and Cognition*, 7, 263-272.

- Titone, D. A. and Connine, C. C. (1999). On the compositional and noncompositional nature of idiomatic expressions. *Journal of Pragmatics*, 31, 1655, 1674.
- Underwood, G., Schmitt, N. and Galpin, A. (2004). The eyes have it: An eye-movement study into the processing of formulaic sequences. In N. Schmitt (ed.). *Formulaic Sequences*, pp. 153-172. Amsterdam and Philadelphia: John Benjamins.
- Wingfield, A. (1968). Effects of frequency on identification and naming objects. *American Journal of Psychology*, 81, 226-234.
- Wray, A. (2002). *Formulaic Sequences and the Lexicon*. Cambridge: Cambridge University Press.